

INCASSI A TERRA,
A PARETE E
DOWNLIGHT

GROUND OR WALL
RECESSED AND
DOWNLIGHT

PASSUM



PASSUM è la famiglia di apparecchi da incasso per esterni ad alte prestazioni, con massima tecnologia di illuminazione e straordinaria flessibilità e precisione nell'installazione. Contraddistinta da solidità, perfetta tenuta stagna, resistenza alla corrosione, si articola nelle diverse versioni in alluminio o acciaio inox AISI 316L.

PASSUM UP è la scelta per l'illuminazione da incasso verso l'alto, modulare e componibile secondo le esigenze, dispone inoltre di una versione ad altezza d'installazione minimizzata - ultraflat.

PASSUM SIDEWARDS è la serie per l'illuminazione radente laterale da incasso su percorsi e pavimentazioni. Le alte prestazioni delle unità LED sono ottimizzate dalle ottiche con tecnologia per l'emissione laterale - side emitter.

PASSUM SPOT rappresenta l'applicazione più innovativa della famiglia, grazie ai performanti LED e alle ottiche orientabili che ne fanno un inedito proiettore da incasso a pavimento.

PASSUM DOWNLIGHT è la versione downlight da incasso a soffitto. Il sistema di ganci di fissaggio consente di montare le lampade precablate, grazie alla versione ultraflat anche in altezze limitate.

PASSUM is the family of high performance recessed luminaires for outdoor use, with maximum lighting technology and extraordinary flexibility and precision in installation. Characterized by solidity, perfect watertightness, resistance to corrosion, it is divided into different versions in aluminum or AISI 316L stainless steel.

PASSUM UP is the choice for upward recessed lighting, modular and adaptable according to all needs, it also has a version with minimized installation height - ultraflat.

PASSUM SIDEWARDS is the series for recessed side grazing lighting on paths and pavements. The high performance of the LED units is optimized by the optics with side emitter technology.

PASSUM SPOT represents the most innovative application of the family, thanks to the high-performance LEDs and the adjustable optics that make it a brand new recessed floor projector.

PASSUM DOWNLIGHT is the recessed ceiling downlight version. The fixing hook system allows pre-wired lamps to be mounted, thanks to the ultraflat version even in limited heights.

GROUND OR WALL RECESSED



PASSUM UP
Ø 70



PASSUM UP
Ø 125



PASSUM UP
Ø 125 ultraflat



PASSUM UP
Ø 180



PASSUM UP
Ø 245



PASSUM SIDEWARDS
Ø 70



PASSUM SIDEWARDS
Ø 125



PASSUM SIDEWARDS
Ø 180



PASSUM SPOT
Ø 180

CEILING RECESSED



PASSUM DOWNLIGHT
Ø 70



PASSUM DOWNLIGHT
Ø 125



PASSUM DOWNLIGHT
Ø 125 ultraflat



PASSUM DOWNLIGHT
Ø 180



PASSUM DOWNLIGHT
Ø 245

PASSUM UP

Massima componibilità

Le lampade della serie sono fornite in 3 elementi separati:

- **controcassa da interrare** a ridotto spessore in tecnopolimero
- **corpo lampada** in alluminio o INOX AISI 316L, disponibile in 4 diametri: Ø 70, 125, 180 e 245 mm. Con vetro temperato trasparente, spessore da 6 a 12 mm. Versione Ø 125 ultraflat a basso spessore con vetro opale
- **flange di chiusura intercambiabili**, fornite a parte, tonde in alluminio primario, tonde e quadre in INOX AISI 316L con viti inox a brugola

Maximum modularity

The lighting fittings of the range are supplied in 3 separate parts:

- low depth **recessing box** in technopolymer
- **light body** in aluminium or AISI 316L stainless steel, available in Ø 70/125/180 and 245 mm. Security tempered glass, thickness from 6 to 12 mm. Ultraflat Ø 125 version with opal glass
- **covering flanges**, supplied separately, available in copper free aluminium or in AISI 316L stainless steel with stainless steel screws

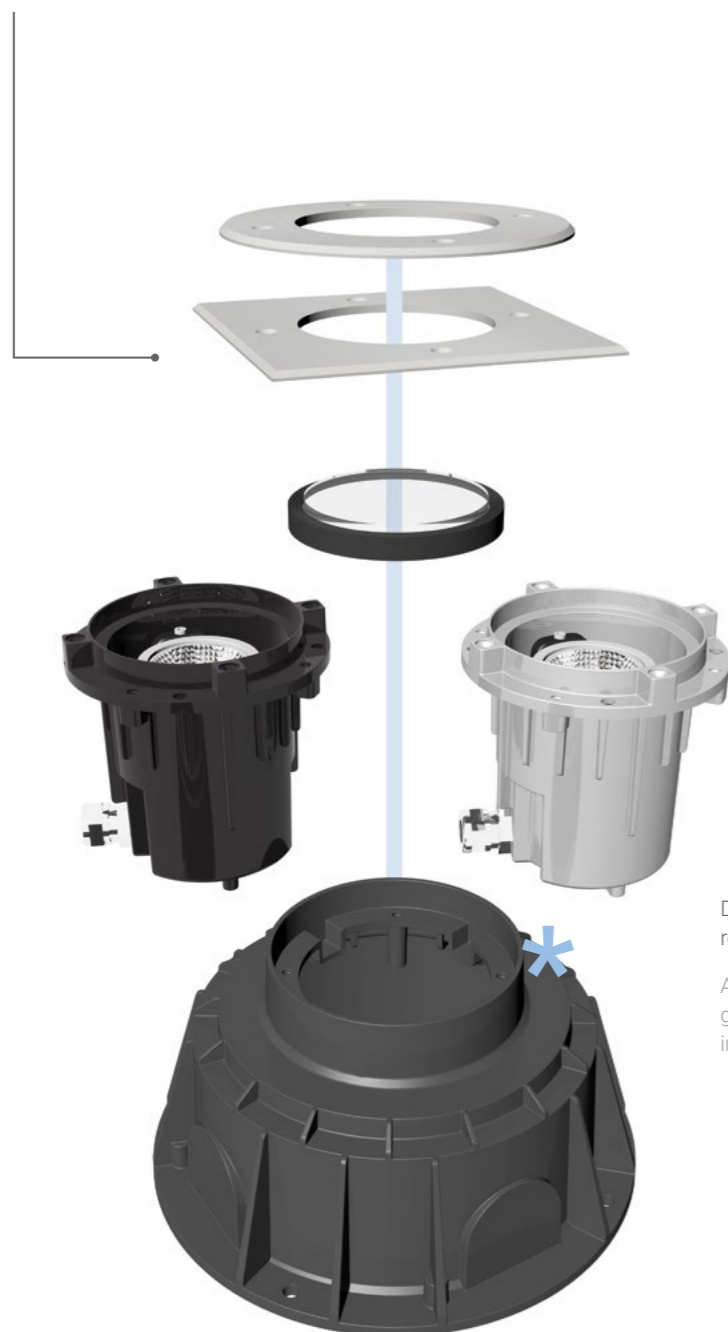

Dopo l'installazione nella cassaforma, è possibile regolare la messa a bolla del corpo lampada.

A complete regulation to align the fitting to the ground is possible even after the recessed box installation.



Calpestabili e carrabili

Carico massimo da 2.000 a 3.500 kg (1.000 kg per Ø 70 mm).

Walk over and drive over

Max load 2.000-3.500 kg (1.000 kg for Ø 70 mm).

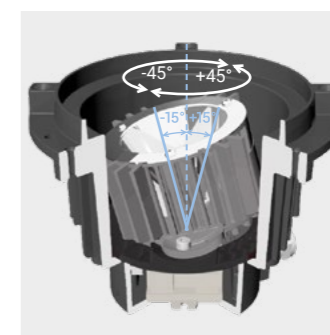

Ottica basculante e rotante

Lottica delle lampade è basculabile per $\pm 15^\circ / 25^\circ$ (escluso Ø 70) e ruota sul piano orizzontale per un corretto posizionamento del fascio luminoso.

Adjustable and rotating optic

Fully adjustable optic (fixed for Ø 70 mm). Vertically $\pm 15^\circ$ for Ø 125 / 180 mm and $\pm 15^\circ / \pm 25^\circ$ for Ø 245 mm. Horizontally for the right firing.



Cavi in dotazione

Fornito con 0,5 m di cavo interrabile H07RN-F per Ø 125 - 180 - 245 (giunti stagni di connessione opzionali da ordinare separatamente - pag. 51). Cavo in silicone 0,2 m con connettori di isolamento termorestringenti per Ø 70.

Cables supplied

Ø 125 - 180 - 245 fittings are pre-wired with 0,5 m H07RN-F cable (optional waterproof connections to be ordered separately - page 51). Ø 70 fittings are pre-wired with 0,2 m silicone cable and heat-shrinkable insulation connectors.

PASSUM UP

Incasso a terra o parete / Ground or wall recessed



CORPI LAMPADA / LIGHT BODIES Ø 70 mm



aluminium



AISI 316L stainless steel

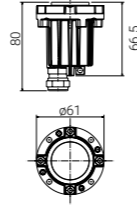

Code	Material	Lamp	W	Lm LED	Real Lm	Optic
1412	aluminium	LED	1	155	88	38°
1413			3	300	162	
1491	AISI 316L stainless steel	LED	1	155	88	38°
1494			3	300	162	

Ottiche opzionali / Optional optics 18° (code + 18), 90° (code + 90)

Driver esterno non compreso / Remote driver to be ordered separately (page 50)

IP 67 con flange / IP 67 with flanges

[Su richiesta / On request](#)

Lunghezza cavo 7 m / 7 m cable length (code + MT7)

CASSAFORMA / IN-GROUND BOX Ø 70 mm

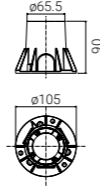

Code	Description
1411	Cassaforma Ø 70 in tecnopolimero da interrare o da parete / In-ground box Ø 70 mm in technopolymer

FLANGE / FLANGES 70 mm



code 1511



code 1512 IN



code 1513 IN

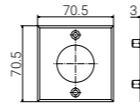
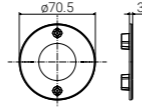

Code	Description
1511	● AN - anthracite ● AG - aluminium grey
1512	● IN - stainless steel
1513	● IN - stainless steel

Description
Flangia tonda Ø 70 in alluminio / Round flange Ø 70 in aluminium
Flangia tonda Ø 70 in acciaio inox AISI 316L / Round flange Ø 70 in AISI 316L stainless steel
Flangia quadrata 70x70 in acciaio inox AISI 316L / Square flange 70x70 in AISI 316L st. steel

[Su richiesta / On request](#)

L'insieme corpo lampada+flangia viene fornito montato, sigillato e orientato / The set light body+flange can be supplied assembled, sealed and oriented

PASSUM UP

Incasso a terra o parete basso spessore / Ground or wall recessed low depth



CORPO LAMPADA / LIGHT BODY Ø 125 mm ULTRAFLAT

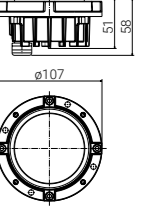

Code	Material	Lamp	W	Lm LED	Real Lm	Optic
1401	aluminium	LED	8	800	347	diffuse
27K - 2700K						
3K - 3000K 4K - 4000K						

Modulo LED a tensione di rete, compatibile con dimmer a taglio di fase / Mains voltage LED module, compatible with most phase-cut dimmers

IP 67 con flange / IP 67 with flanges

[Su richiesta / On request](#)

24V low voltage (code + 24V)

CASSAFORMA / IN-GROUND BOX Ø 125 mm ULTRAFLAT

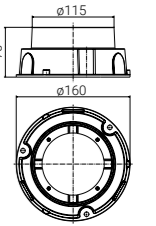

Code	Description
1423	Cassaforma ultraflat Ø 125 mm con profondità di incasso molto contenuta in tecnopolimero / Ultraflat in-ground box Ø 125 mm in technopolymer

FLANGE / FLANGES 125 mm



code 1521



code 1522 IN



code 1523 IN

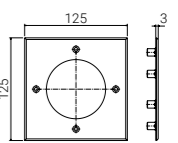
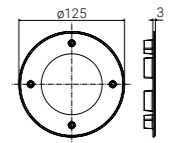

Code	Description
1521	● AN - anthracite ● AG - aluminium grey
1522	● IN - stainless steel
1523	● IN - stainless steel

Description
Flangia tonda Ø 125 in alluminio / Round flange Ø 125 in aluminium
Flangia tonda Ø 125 in acciaio inox AISI 316L / Round flange Ø 125 in AISI 316L stainless steel
Flangia quadrata 125 x 125 in acciaio inox AISI 316L / Square flange 125 x 125 in AISI 316L st. steel

[Su richiesta / On request](#)

L'insieme corpo lampada+flangia viene fornito montato, sigillato e orientato / The set light body+flange can be supplied assembled, sealed and oriented

PASSUM UP

Incasso a terra o parete / Ground or wall recessed



CORPI LAMPADA / LIGHT BODIES Ø 125 mm



aluminium AISI 316L stainless steel

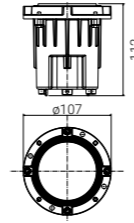

Code	Material	Lamp	W	Lm LED	Real Lm	Optic	
1422	aluminium	27K - 2700K 3K - 3000K 4K - 4000K	LED	8	951	636	38°
1424		-	GU10	5	-	-	-
1495	AISI 316L stainless steel	27K - 2700K 3K - 3000K 4K - 4000K	LED	4	430	289	38°
1496		-	GU10	5	-	-	-

Ottiche opzionali / Optional optics 18° (code + 18), 90° (code + 90)
 Ottiche basculanti / Adjustable optics 1422, 1495 ±15° / 1424, 1496 ± 8°
 Versione RGBW (vedi capitolo dedicato) / RGBW version (see related chapter)
 GU10 L max 57 mm (forniti senza lampadina / supplied without lamp)
 IP 67 con flange / IP 67 with flanges

Su richiesta / On request
 12-24V low voltage

CASSAFORMA / IN-GROUND BOX Ø 125 mm

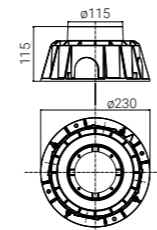

Code	Description
1421	Cassaforma Ø 125 in tecnopolimero da interrare o da parete / In-ground box Ø 125 mm in technopolymer

PASSUM UP

Incasso a terra o parete / Ground or wall recessed



FLANGE / FLANGES 125 mm



code 1521



code 1522 IN



code 1523 IN

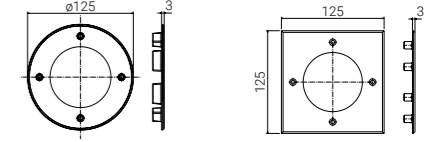

Code	Description
1521	Flangia tonda Ø 125 in alluminio / Round flange Ø 125 in aluminium
1522	Flangia tonda Ø 125 in acciaio inox AISI 316L / Round flange Ø 125 in AISI 316L stainless steel
1523	Flangia quadrata 125 x 125 in acciaio inox AISI 316L / Square flange 125 x 125 in AISI 316L st. steel

Su richiesta / On request

L'insieme corpo lampada+flangia viene fornito montato, sigillato e orientato /
 The set light body+flange can be supplied assembled, sealed and oriented



PASSUM UP

Incasso a terra o parete / Ground or wall recessed



CORPI LAMPADA / LIGHT BODIES Ø 180 mm



aluminium AISI 316L stainless steel

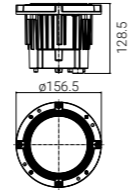

Code	Material	Lamp	W	Lm LED	Real Lm	Optic
1432	aluminium	LED	11	1405	1060	38°
1433			16	2643	1819	
1434	AISI 316L stainless steel	GU10	7-8	-	-	-
1497		LED	8	951	636	38°
1498	AISI 316L stainless steel	GU10	7-8	-	-	-

Ottiche opzionali / Optional optics 18° (code + 18), 90° (code + 90)

Ottiche basculanti / Adjustable optics ±15°

Versione RGBW (vedi capitolo dedicato) / RGBW version (see related chapter)

GU10 L max 86 mm (forniti senza lampadina / supplied without lamp)

IP 67 con flange / IP 67 with flanges

CASSAFORMA / IN-GROUND BOX Ø 180 mm

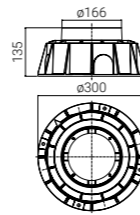

Code	Description
1431	Cassaforma Ø 180 mm in tecnopolimero da interrare o da parete / In-ground box Ø 180 mm in technopolymer

PASSUM UP

Incasso a terra o parete / Ground or wall recessed



FLANGE / FLANGES 180 mm



code 1531



code 1532 IN



code 1533 IN

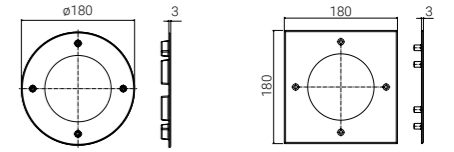

Code	Description
1531	Flangia tonda Ø 180 in alluminio / Round flange Ø 180 in aluminium
1532	Flangia tonda Ø 180 in acciaio inox AISI 316L / Round flange Ø 180 in AISI 316L stainless steel
1533	Flangia quadrata 180 x 180 in acciaio inox AISI 316L / Square flange 180 x 180 in AISI 316L st. steel

Su richiesta / On request

L'insieme corpo lampada+flangia viene fornito montato, sigillato e orientato / The set light body+flange can be supplied assembled, sealed and oriented





PASSUM UP

Incasso a terra / Ground recessed



CORPI LAMPADA / LIGHT BODIES Ø 245 mm



code 1440



code 1442

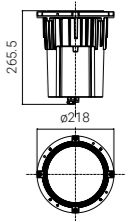

	Code	Material	Lamp	W	Lm LED	Real Lm	Optic
1440	27K - 2700K 3K - 3000K	aluminium	LED	23	3329	2434	38°
1442	4K - 4000K			29,5	4215	3180	
1444	-		E27	30	-	-	-

Ottiche opzionali / Optional optics

1440, 1442 18° (code + 18), 1440 70° (code + 70), 1442 90° (code + 90)

Ottiche basculanti / Adjustable optics 1440 ±15°, 1442, 1444 ±25°

Versione RGBW (vedi capitolo dedicato) / RGBW version (see related chapter)

E27 L max 195 mm (fornito senza lampadina / supplied without lamp)

IP 67 con flange / IP 67 with flanges

Su richiesta / On request

Versione dimmerabile / Dimmable version

CASSAFORMA / IN-GROUND BOX Ø 245 mm

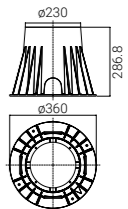

Code

Description

1441

Cassaforma Ø 245 mm in tecnopolimero da interrare / In-ground box Ø 245 mm in technopolymer

FLANGE / FLANGES Ø 245 mm



code 1541



code 1542 IN

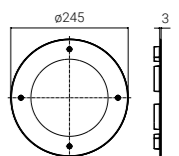

Code

Description

1541

- AN - anthracite
- AG - aluminium grey

Flangia tonda Ø 245 in alluminio / Round flange Ø 245 in aluminium

1542

- IN - stainless steel

Flangia tonda Ø 245 in acciaio inox AISI 316L / Round flange Ø 245 in AISI 316L stainless steel

Su richiesta / On request

L'insieme corpo lampada+flangia viene fornito montato, sigillato e orientato / The set light body+flange can be supplied assembled, sealed and oriented

PASSUM SIDEWARDS



Calotte intercambiabili

Sono fornite a parte con diverse possibilità di orientare la luce radente e finiture.

Changeable canopies

The covering canopies, in different finishing, allow several light emissions.



Dopo l'installazione nella cassaforma, è possibile regolare la messa a bolla del corpo lampada.

A complete regulation to align the fitting to the ground is possible even after the recessed box installation.

Massima componibilità

Le lampade della serie sono fornite in 3 elementi separati:

- **controcassa da interrare** a ridotto spessore in tecnopolimero
- **corpo lampada** in alluminio o INOX AISI 316L, disponibile in 3 diametri: Ø 70, 125 e 180 mm. Diffusore in policarbonato anti UV
- **calotte di chiusura**, fornite a parte, con diverse possibilità di illuminazione radente: singola, doppia 2x90°, 180° e 360°

Maximum modularity

The lighting fittings of the range are supplied in 3 separate parts:

- low depth **recessing box** in technopolymer
- **light body** in aluminium or AISI 316L stainless steel, available in Ø 70/125 and 180 mm. UV resistant polycarbonate diffuser
- **covering canopies**, supplied separately, available in different emissions: 90°, 2x90°, 180° and 360°



Calpestabili e carrabili

T_s ≤ 40°C. Carico massimo 2.000 kg.

Walk over and drive over

Surface T_s ≤ 40°C and max load 2.000 kg.

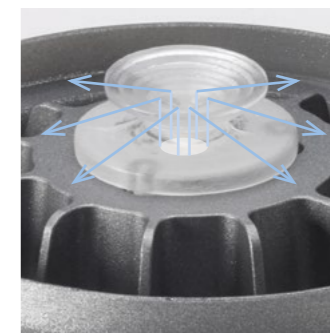

Ottica side emitter

LED con ottica side emitter progettata per deviare tutta la luce radente sui lati.

Side emitter optic

The lens directs the light along the ground surface.



Cavi in dotazione

Fornito con 0,5 m di cavo interrabile H07RN-F per Ø 125 - 180 (giunti stagni di connessione opzionali da ordinare separatamente - pag. 51). Cavo in silicone 0,2 m con connettori di isolamento termorestringenti per Ø 70.

Cables supplied

Ø 125 - 180 fittings are pre-wired with 0,5 m H07RN-F cable (optional waterproof connections to be ordered separately - page 51). Ø 70 fittings are pre-wired with 0,2 m silicone cable and heat-shrinkable insulation connectors.

PASSUM SIDEWARDS

Incasso a terra o parete / Ground or wall recessed



CORPI LAMPADA / LIGHT BODIES Ø 70 mm



aluminium



AISI 316L stainless steel

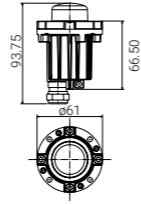

Code	Material	Lamp	W	Lm LED	Real Lm	Optic
1415	aluminium	LED	1	155	1x33	-
1416			3	300	1x65	
1481	AISI 316L stainless steel	LED	1	155	1x33	-
1484			3	300	1x65	

Driver esterno non compreso / Remote driver to be ordered separately (page 50)
IP 67 con calotte / IP 67 with canopies

Su richiesta / On request
Lunghezza cavo 7 m / 7 m cable length (code + **MT7**)

CASSAFORMA / IN-GROUND BOX Ø 70 mm

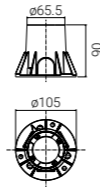

Code	Description
1411	Cassaforma Ø 70 in tecnopolimero da interrare o da parete / In-ground box Ø 70 mm in technopolymer

PASSUM SIDEWARDS

Incasso a terra o parete / Ground or wall recessed



CALOTTE DI CHIUSURA / COVERING CANOPIES Ø 70 mm



code 1515



code 1516



code 1517



code 1519

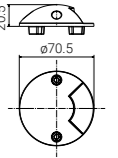

code 1591 IN



code 1593 IN



code 1594 IN

Code	Description
1515	Calotta 1x90° in alluminio / Canopy 1x90° in aluminium
1516	Calotta 180° in alluminio / Canopy 180° in aluminium
1517	Calotta 2x90° in alluminio / Canopy 2x90° in aluminium
1519	Calotta 360° in alluminio / Canopy 360° in aluminium
1591	Calotta 1x90° in acciaio inox AISI 316L / Canopy 1x90° in AISI 316L stainless steel
1593	Calotta 2x90° in acciaio inox AISI 316L / Canopy 2x90° in AISI 316L stainless steel
1594	Calotta 360° in acciaio inox AISI 316L / Canopy 360° in AISI 316L stainless steel

1515, 1516, 1517, 1519 Carico max. / Max load 2.000 kg
1591, 1593, 1594 Carico max. / Max load 500 kg

Su richiesta / On request
L'insieme corpo lampada+calotta viene fornito montato e sigillato /
The set light body+canopy can be supplied assembled and sealed

code 1427 + 1525



PASSUM SIDEWARDS

Incasso a terra o parete / Ground or wall recessed



CORPI LAMPADA / LIGHT BODIES Ø 125 mm

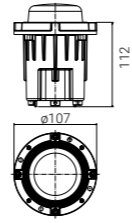

Code	Material	Lamp	W	Lm LED	Real Lm	Optic
1427	aluminium	LED	4	430	1x68	-
1485	AISI 316L stainless steel					

IP 67 con calotte / IP 67 with canopies

Su richiesta / On request
12-24V low voltage (code + LV)

CASSAFORMA / IN-GROUND BOX Ø 125 mm

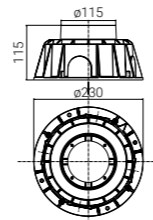

Code	Description
1421	Cassaforma Ø 125 in tecnopolimero da interrare o da parete / In-ground box Ø 125 mm in technopolymer

CALOTTE DI CHIUSURA / COVERING CANOPIES Ø 125 mm

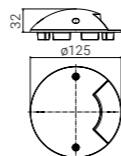

Code	Description
1525	Calotta 1x90° in alluminio / Canopy 1x90° in aluminium
1526	Calotta 180° in alluminio / Canopy 180° in aluminium
1527	Calotta 2x90° in alluminio / Canopy 2x90° in aluminium
1529	Calotta 360° in alluminio / Canopy 360° in aluminium

Su richiesta / On request
L'insieme corpo lampada+calotta viene fornito montato e sigillato /
The set light body+canopy can be supplied assembled and sealed

PASSUM SIDEWARDS

Incasso a terra o parete / Ground or wall recessed



CORPI LAMPADA / LIGHT BODIES Ø 180 mm

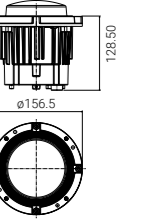

Code	Material	Lamp	W	Lm LED	Real Lm	Optic
1436	aluminium	LED	11	1405	1x86	-
1487	AISI 316L stainless steel					

IP 67 con calotte / IP 67 with canopies

CASSAFORMA / IN-GROUND BOX Ø 180 mm

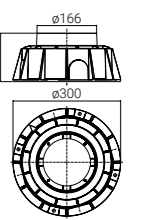

Code	Description
1431	Cassaforma Ø 180 mm in tecnopolimero da interrare o da parete / In-ground box Ø 180 mm in technopolymer

CALOTTE DI CHIUSURA / COVERING CANOPIES Ø 180 mm

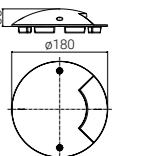

Code	Description
1535	Calotta 1x90° in alluminio / Canopy 1x90° in aluminium
1536	Calotta 180° in alluminio / Canopy 180° in aluminium
1537	Calotta 2x90° in alluminio / Canopy 2x90° in aluminium
1539	Calotta 360° in alluminio / Canopy 360° in aluminium

Su richiesta / On request
L'insieme corpo lampada+calotta viene fornito montato e sigillato /
The set light body+canopy can be supplied assembled and sealed

PASSUM SPOT

Prodotto completo

Le lampade della serie sono fornite assemblate:

- **corpo lampada** in alluminio o acciaio INOX AISI 316L. Diffusore in policarbonato anti UV
- **calotta di chiusura** in alluminio primario a doppia verniciatura



Complete product

The lighting fittings of the range are supplied assembled:

- **light body** in aluminium or AISI 316L stainless steel. UV resistant polycarbonate diffuser
- **covering canopy** in aluminium with double layer of powder painting



Controcassa

Controcassa da interrare a ridotto spessore in tecnopolimero.

In-ground box

Low depth **recessing box** in technopolymer.

Dopo l'installazione nella cassaforma, è possibile regolare la messa a bolla del corpo lampada.

A complete regulation to align the fitting to the ground is possible even after the recessed box installation.

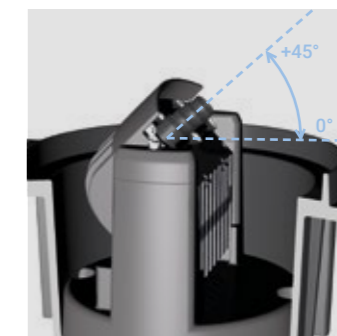

Ottica orientabile

Il gruppo ottico è facilmente regolabile sul piano verticale e consente di orientare la luce da 0° a +45° nella direzione desiderata.

Adjustable optic

The optic unit is easily adjustable and permits to orient the light at the ground surface until 45° upwards.



PASSUM SPOT

Incasso a terra o parete / Ground or wall recessed



LAMPADE CON CALOTTA E LUCE ORIENTABILE / LUMINAIRES WITH CANOPY AND ADJUSTABLE OPTIC Ø 180 mm

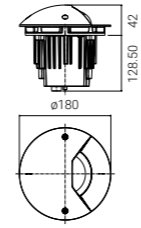

Code			Material	Lamp	W	Lm LED	Real Lm	Optic
1438	● AN - anthracite	3K - 3000K	aluminium body	LED	8	850	605	40°
1488	● AG - aluminium grey	4K - 4000K	AISI 316L st. steel body					

Ottiche opzionali / Optional optics 12° (code + 12)
 Ottiche orientabili / Adjustable optics 0° +45°

CASSAFORMA / IN-GROUND BOX Ø 180 mm

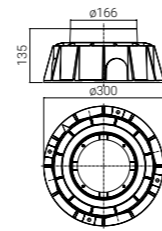

Code	Description
1431	Cassaforma Ø 180 mm in tecnopolimero da interrare o da parete / In-ground box Ø 180 mm in technopolymer



PASSUM DOWNLIGHT

Struttura

Corpo lampada in alluminio primario a basso contenuto di rame, verniciato con polveri poliestere anticorrosione dopo fosfocromatazione. Vetro temperato trasparente o opale a richiesta; spessore da 6 a 12 mm.

Disponibile in 4 diametri: Ø 70, 125, 180 e 245 mm **forniti con flange di chiusura** in alluminio (flange INOX tonde o quadrate a richiesta). Versione Ø 125 ultraflat a basso spessore con vetro opale.

Structure

Lamp body in low copper content primary aluminium with pre-phosphochrome corrosion protection polyester powder coating. Transparent tempered glass, opal upon request, thickness from 6 to 12 mm.

Available in 4 diameters: Ø 70, 125, 180 and 245 mm **supplied with aluminium closing flanges** (round or square stainless steel flanges upon request). Ultraflat Ø 125 version with opal glass.

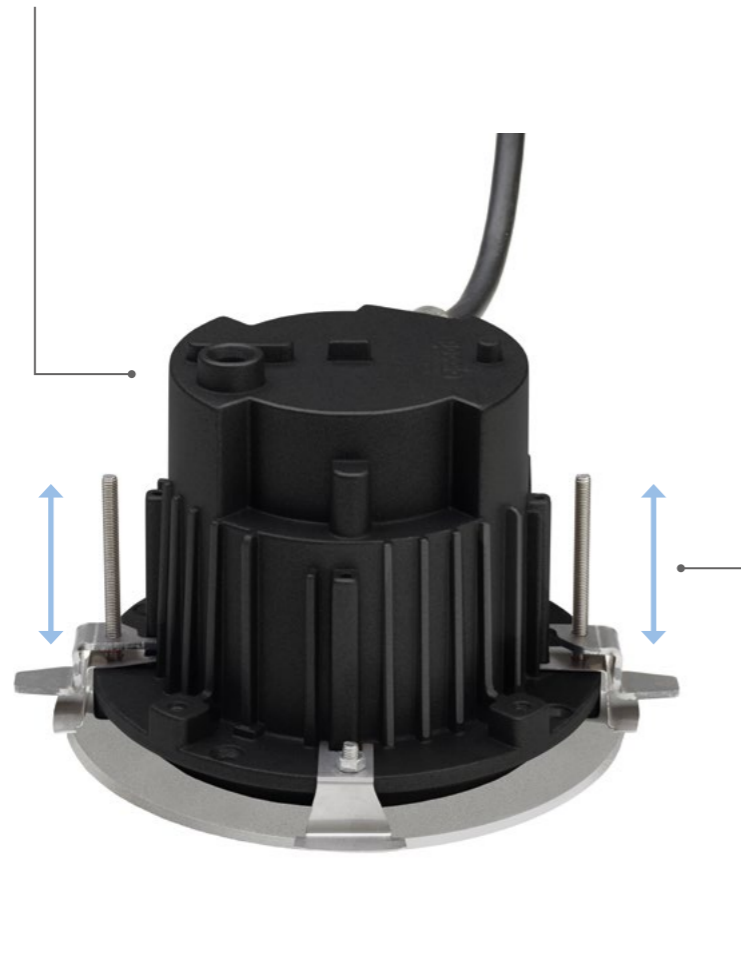

Staffe di fissaggio

Staffe di fissaggio in dotazione per spessori da 5 a 50 mm. Avvitando le viti di bloccaggio in senso orario, le staffe si dispongono nella posizione di aggancio fino a serrare l'apparecchio al controsoffitto.

Fastening brackets

Fastening brackets supplied, for thicknesses from 5 to 50 mm. Tighten the locking screws in the clockwise direction to arrange the hooking position until the fitting is secured to the false ceiling.

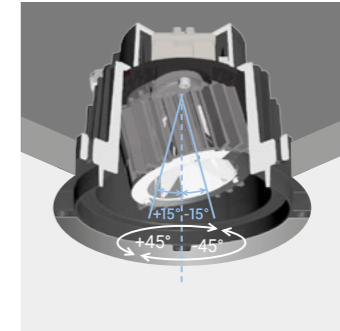
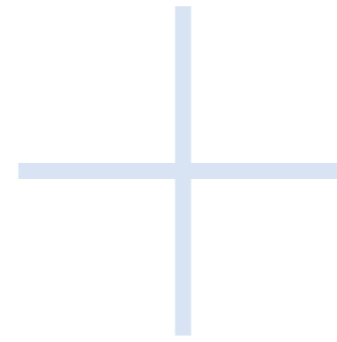

Ottica basculante e rotante

L'ottica delle lampade è basculabile per $\pm 15^\circ / 25^\circ$ (escluso Ø 70) e ruota sul piano orizzontale per un corretto posizionamento del fascio luminoso.

Adjustable and rotating optic

Fully adjustable optic (fixed for Ø 70 mm). Vertically $\pm 15^\circ$ for Ø 125 / 180 mm and $\pm 15^\circ / \pm 25^\circ$ for Ø 245 mm. Horizontally for the right firing.



Cavi in dotazione

Fornito con 0,5 m di cavo H07RN-F per Ø 125 - 180 - 245. Cavo in silicone 0,2 m con connettori di isolamento termorestringenti per Ø 70.

Cables supplied

Ø 125 - 180 - 245 fittings are pre-wired with 0,5 m H07RN-F cable. Ø 70 fittings are pre-wired with 0,2 m silicone cable and heat-shrinkable insulation connectors.

PASSUM DOWNLIGHT

Incasso a soffitto / Ceiling recessed

CRI 80 IP 65 IP 67 UK CA CE

LAMPADA / LUMINAIRE Ø 70 mm

24V DC IK 08

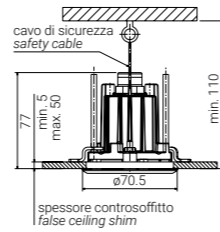

Code		
1470	● AN - anthracite	27K - 2700K
	● 3K - 3000K	
	● AG - aluminium grey	4K - 4000K

Lamp	W	Lm LED	Real Lm	Optic
LED	3	300	162	38°

Ottiche opzionali / Optional optics 18° (code + 18), 90° (code + 90)
 Driver esterno non compreso / Remote driver to be ordered separately (page 50)
 Foro controsoffitto / False ceiling hole Ø min. 65 mm - Ø max. 66 mm

Su richiesta / On request
 ● IN - stainless steel

PASSUM DOWNLIGHT

Incasso a soffitto / Ceiling recessed

230V 50Hz IP 65 IP 67 IK 10 UK CA CE

LAMPADA / LUMINAIRE Ø 125 mm ultraflat

CRI ≥ 80

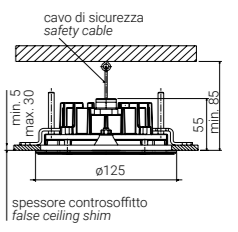

Code		
1479	● AN - anthracite	27K - 2700K
	● 3K - 3000K	
	● AG - aluminium grey	4K - 4000K

Lamp	W	Lm LED	Real Lm	Optic
LED	8	800	347	diffuse

Modulo LED a tensione di rete, compatibile con dimmer a taglio di fase /
 Mains voltage LED module, compatible with most phase-cut dimmers
 Foro controsoffitto / False ceiling hole Ø min. 115 mm - Ø max. 116 mm

Su richiesta / On request
 24V low voltage (code + 24V)
 ● IN - stainless steel

LAMPADE / LUMINAIRES Ø 125 mm

230V 50Hz IK 10

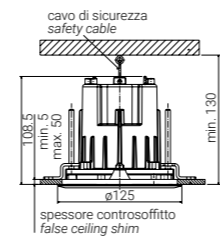

Code		
1472	● AN - anthracite	27K - 2700K
	● 3K - 3000K	
	● AG - aluminium grey	4K - 4000K
1473	-	-

Lamp	W	Lm LED	Real Lm	Optic
LED	8	951	636	38°
GU10	5	-	-	-

Ottiche opzionali / Optional optics 18° (code + 18), 90° (code + 90)
 Ottiche basculanti / Adjustable optics 1472 ±15°, 1473 ±8°
 GU10 L max 57 mm (fornita senza lampadina / supplied without lamp)
 Foro controsoffitto / False ceiling hole Ø min. 115 mm - Ø max. 116 mm

Su richiesta / On request
 12-24V low voltage
 Versione RGBW / RGBW version
 ● IN - stainless steel

LAMPADE / LUMINAIRES Ø 180 mm

CRI 80

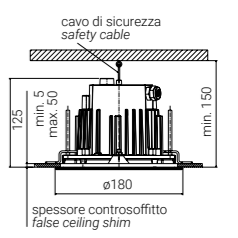

Code		
1474	● AN - anthracite	27K - 2700K
	● 3K - 3000K	
	● AG - aluminium grey	4K - 4000K
1475	-	-

Lamp	W	Lm LED	Real Lm	Optic
LED	11	1405	1060	38°
	16	2643	1819	

Ottiche opzionali / Optional optics 18° (code + 18), 90° (code + 90)
 Ottiche basculanti / Adjustable optics ±15°
 Foro controsoffitto / False ceiling hole Ø min. 164 mm - Ø max. 165 mm

Su richiesta / On request
 Versione RGBW / RGBW version
 ● IN - stainless steel

PASSUM DOWNLIGHT

Incasso a soffitto / Ceiling recessed



LAMPADE / LUMINAIRES Ø 245 mm

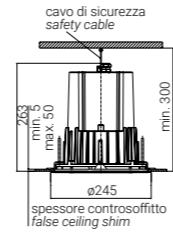

Code

Code		
1471	● AN - anthracite	27K - 2700K 3K - 3000K
1476	● AG - aluminium grey	4K - 4000K
1478		-

Ottiche opzionali / Optional optics

1471,1476 18° (code + **18**), 1471 70° (code + **70**), 1476 90° (code + **90**)

Ottiche basculanti / Adjustable optics 1471 ±15°, 1476,1478 ±25°

E27 L max 195 mm (fornita senza lampadina / supplied without lamp)

Foro controsoffitto / False ceiling hole Ø min. 225 mm - Ø max. 226 mm

Lamp	W	Lm LED	Real Lm	Optic
LED	23	3329	2434	38°
	29,5	4215	3180	
E27	30	-	-	-

Su richiesta / On request

Versione dimmerabile / Dimmable version

Versione RGBW / RGBW version

● IN - stainless steel



ALIMENTATORI 24V DC / 24V DC CONTROL GEARS

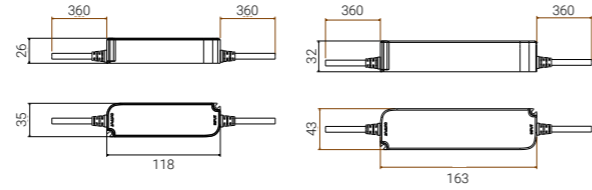

code 1924

code 1925

Code	W	Description
1924	24	INPUT 220-240 V - OUTPUT 24V DC
1925	60	

1924 controlla da 1 a 7 apparecchi PASSUM Ø 70 mm / controls from 1 to 7 luminaires PASSUM Ø 70 mm

1925 controlla da 8 a 18 apparecchi PASSUM Ø 70 mm / controls from 8 to 18 luminaires PASSUM Ø 70 mm

GIUNTI STAGNI / WATERPROOF CONNECTIONS



code 1941



code 1942

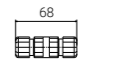

code 1941

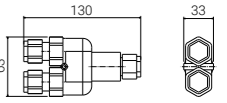

code 1942



code 1944

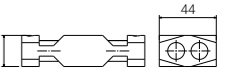

code 1944

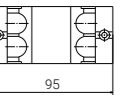

Code	Description
1941	Connessione singola 3x2,5 mm ² IP68 / Single connector 3x2,5 mm ² IP 68
1942	Connessione entra-esce 3x2,5 mm ² IP68 / Through wiring connector 3x2,5 mm ² IP 68
1944	Connessione fino a 4 uscite 3x2,5 mm ² IP68 (basato su gel siliconico bicomponente) / Up to 4 outputs connector 3x2,5 mm ² IP 68, based on two-component silicone gel



GRIGLIE ANTIABBAGLIANTI PER PASSUM UP / PASSUM UP ANTIGLARE LOUVERS



code 1971



code 1972

Code	Description	Ref. to
1971	Frangiluce / Antiglare louver PASSUM UP Ø 180	code 1432 code 1433
1972	Frangiluce / Antiglare louver PASSUM UP Ø 245	code 1442