

LAMPADE  
SEGNAPASSO A  
PARETE E SU PALO

STEPLIGHT FITTINGS  
AND POSTS

# STAMP



La serie STAMP di lampade per esterno amplia il concetto di installazione di superficie e di incasso a parete. La sporgenza minima di 25 o 30 mm offre un'installazione radente senza incasso nella parete.

L'ottica della luce orientata in basso ottimizza la funzione di segnapasso. STAMP è disponibile anche nelle versioni con luce frontale in vetro o laterale sul muro. La lampada dal design essenziale contiene unità LED altamente tecnologiche e di grande resa luminosa. Un distanziale dedicato permette anche l'ingresso / uscita cavi laterale.

La serie si completa con le controcasse accessorio che consentono l'installazione da incasso a filo parete e con i pali STAMP POST di diverse dimensioni, anche in bi-emissione.

The STAMP series of outdoor lamps expands the concept of surface installation and wall recessing. The minimum overhang of 25 or 30 mm offers a grazing installation without recess in the wall.

The optic of the light oriented downwards optimizes the path marker function. STAMP is also available in versions with glass front or side light on the wall. The essential design lamp contains highly technological LED units with great light output. A dedicated spacer also allows for lateral cable entry / exit.

The series is completed with accessory backboxes that allow flush-mounted installation and with STAMP POST poles of different sizes, also in bi-emission.

## STEPLIGHT FITTINGS



STAMP  
110



STAMP  
175



STAMP  
280



STAMP GLASS

## STEPLIGHT FITTINGS AND WALL EFFECTS



STAMP SIDE LIGHT  
one window



STAMP SIDE LIGHT  
two windows



STAMP SIDE LIGHT  
four windows

## POSTS



STAMP POST  
H 300-600



STAMP POST  
H 600-900



STAMP POST GLASS  
H 300-600

# STAMP

## Struttura

Corpo lampada in alluminio primario anticorrosione a basso contenuto di rame. Diffusore in policarbonato anti UV, recesso per una riduzione efficace dell'abbagliamento diretto.

## Structure

Body in low copper content primary aluminium. Diffuser in UV resistant polycarbonate, recessed for an effective reduction of direct glare.

## Sporgenza minima Minimum thickness

25-30 mm

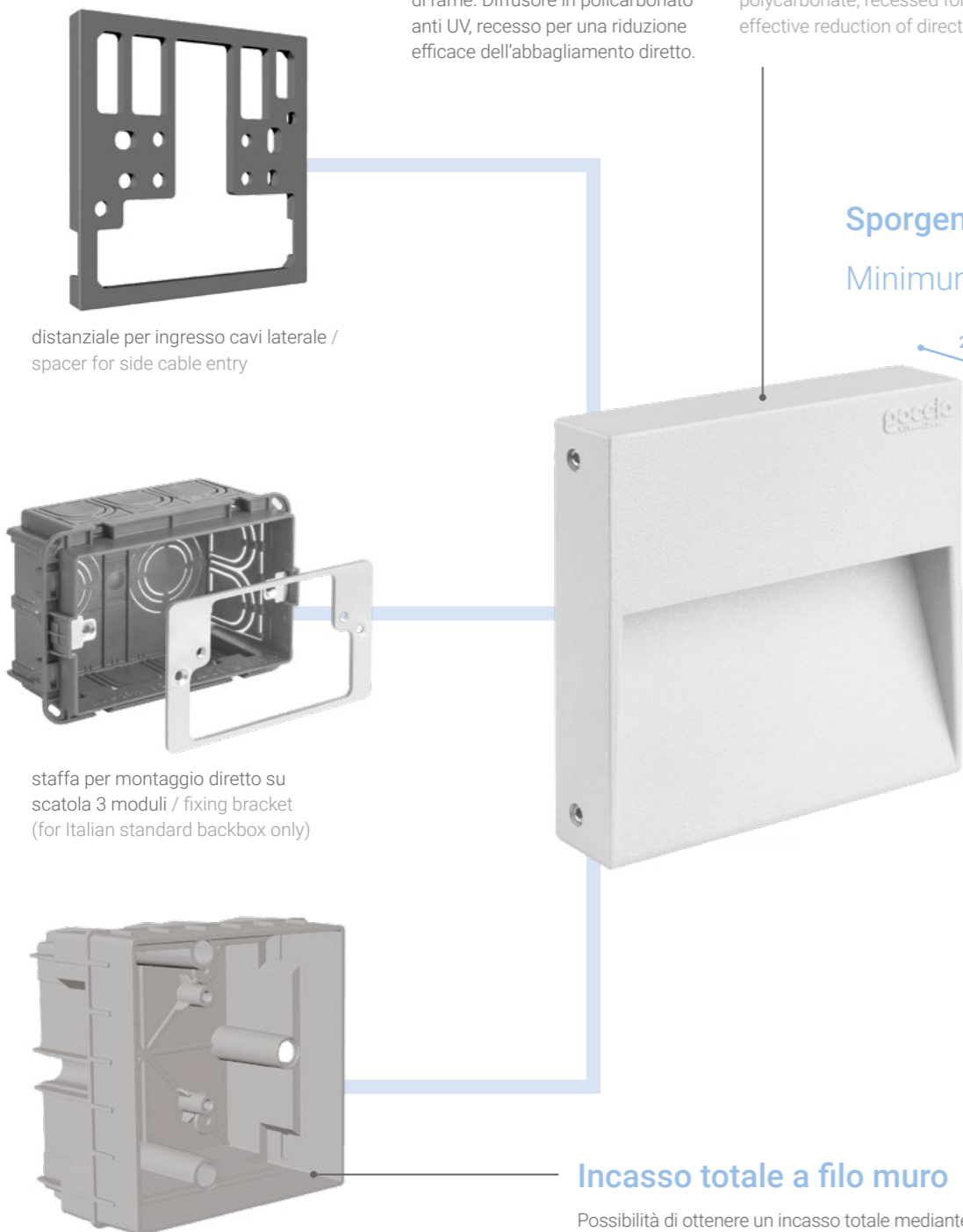

distanziale per ingresso cavi laterale /  
spacer for side cable entry

staffa per montaggio diretto su  
scatola 3 moduli / fixing bracket  
(for Italian standard backbox only)

controcassa per incasso totale /  
backbox for flush recessing

## Incasso totale a filo muro

Possibilità di ottenere un incasso totale mediante le apposite controcasse fornite con coperchio di protezione.

## Wall flush installation

Dedicated backboxes, supplied with protection cover, allow flush recessing.

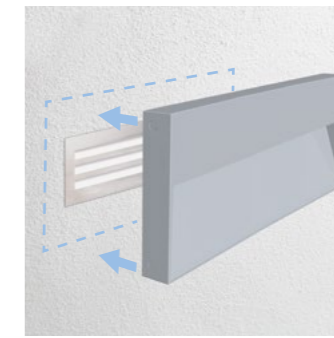
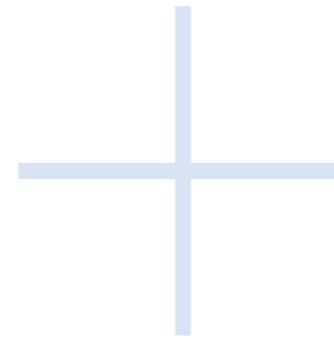

## Montaggio a sormonto

La soluzione a superficie risolve la necessità di coprire vani dovuti a precedenti installazioni.

## Overlap mounting

The surface solution solves any needs of covering holes due to previous installations.

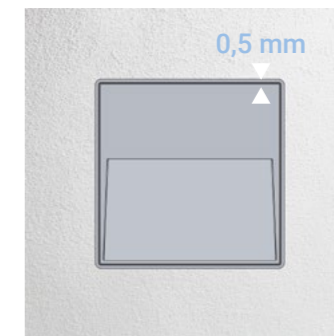

0,5 mm

## Fessura minima

La fessura tra lampada e controcassa è limitata a soli 0,5 mm.

## Minimum slot

The space between the backbox and the recessed light fitting is 0,5 mm only.



## Agevole estrazione del corpo lampada

Estrazione semplice del corpo lampada mediante la trazione con le dita sulla palpebra.

## Easy luminaire extraction

Remove the light fitting from the backbox by a simple hand pull.

# STAMP

Lampada segnapasso / Steplight fitting



## STAMP 110

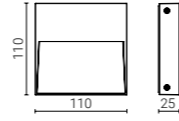

Code	
5321	● AN - anthracite
	● AG - aluminium grey
	○ BI - white
	● CO - corten

27K - 2700K  
3K - 3000K  
4K - 4000K

Lamp	W	Lm LED	Real Lm	Optic
LED	4	460	210	asym.

Modulo LED a tensione di rete, compatibile con dimmer a taglio di fase / Mains voltage LED module, compatible with most phase-cut dimmers

**Su richiesta / On request**

24V low voltage (code + 24V)

● BR - bronze

## STAMP 175-280



code 5323



code 5326

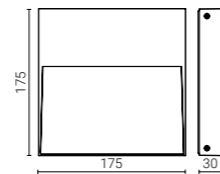

code 5323

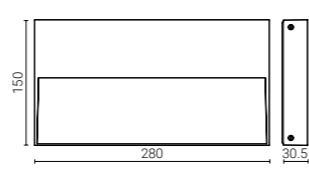

code 5326

Code	
5323	● AN - anthracite
	● AG - aluminium grey
5326	○ BI - white
	● CO - corten

27K - 2700K  
3K - 3000K  
4K - 4000K

Lamp	W	Lm LED	Real Lm	Optic
LED	8	1077	520	asym.
	16	2345	936	asym.

5323 Driver dimmerabile a taglio di fase / Phase-cut dimmable driver

**Su richiesta / On request**

24÷48V low voltage (code + LV)

Versione dimmerabile / Dimmable version

● BR - bronze

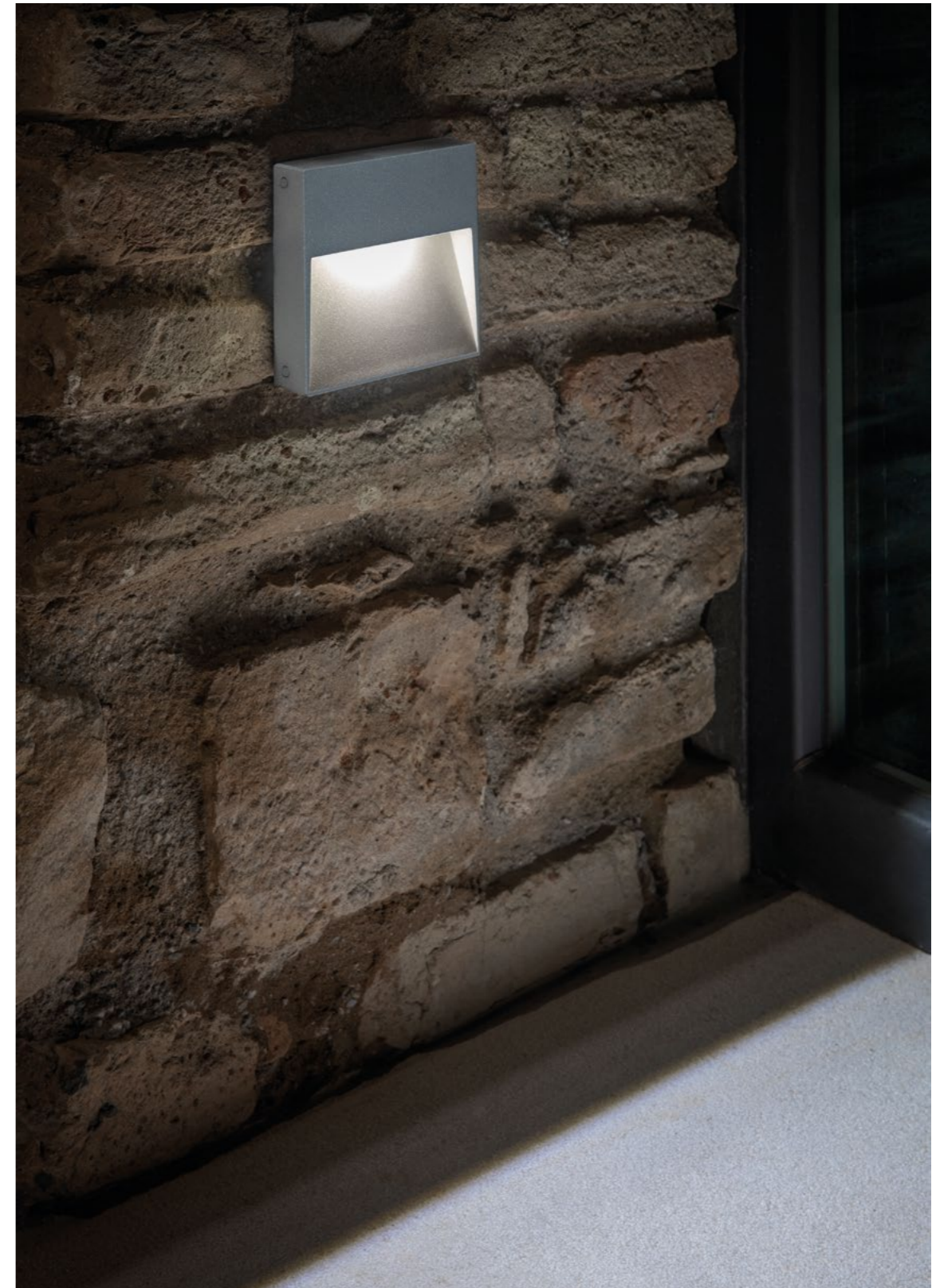

# STAMP

Accessori / Accessories



## DISTANZIALI / SPACERS



code 5351



code 5352

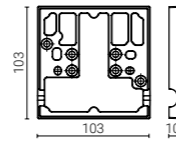

code 5351

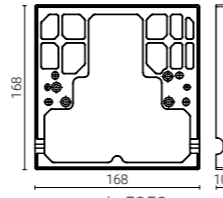

code 5352

Code	Description	Ref. to
5351	Distanziale per ingresso cavi laterale / Spacer for side cable entry	code 5321
5352	Distanziale per ingresso cavi laterale, cablaggio entra/esci consentito / Spacer for side cable entry, through wiring allowed	code 5323

# STAMP

Accessori / Accessories



## STAFFA PER SCATOLA 3 MOD. / FIXING BRACKET



Code	Description	Ref. to
5360	Staffa per fissaggio a sporgere su cassetta 3 moduli standard / Fixing bracket (for Italian standard backbox only)	code 5321

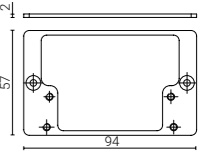

## CONTROCASSE / BACKBOXES



code 5358



code 5359

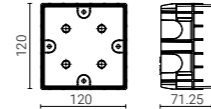

code 5358

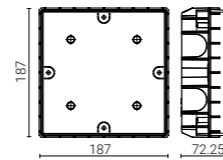

code 5359

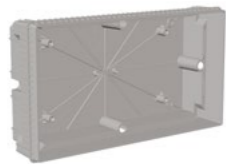

code 5357

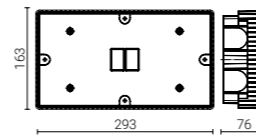

code 5357

Code	Description	Ref. to
5358	Controcassa per incasso totale, completa di coperchio / Backbox for wall flush installation, complete with cover	code 5321
5359		code 5323
5357		code 5326



# STAMP POST

Pali / Posts

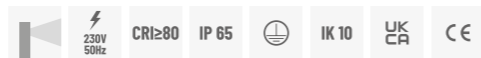

## PALI / POSTS H 300-600

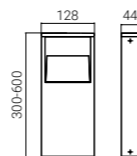

	Code	H	Lamp	W	Lm LED	Real Lm	Optic
5371	● AN - anthracite 27K - 2700K 3K - 3000K	300 mm	LED	4	460	210	asym.
5372	● AG - aluminium grey 4K - 4000K	600 mm					

Pali in alluminio completi di apparecchio e cavo precablato H05RN-F / Posts in aluminium, fitting and H05RN-F pre-wired cable included

Modulo LED a tensione di rete, compatibile con dimmer a taglio di fase / Mains voltage LED module, compatible with most phase-cut dimmers

**Su richiesta / On request**  
24V low voltage (code + 24V)

● CO - corten

## PALI / POSTS H 600-900

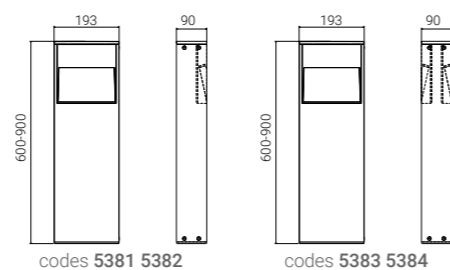

	Code	H	Lamp	W	Lm LED	Real Lm	Optic
5381	● AN - anthracite 27K - 2700K 3K - 3000K	600 mm	LED	8	1077	520	asym.
5382		900 mm					
5383	● AG - aluminium grey 4K - 4000K	600 mm		16 (2x8)	2154	1040	
5384	900 mm						

Pali in alluminio completi di apparecchio e cavo precablato H05RN-F / Posts in aluminium, fitting and H05RN-F pre-wired cable included

Driver dimmerabile a taglio di fase / Phase-cut dimmable driver

**Su richiesta / On request**  
24=48V low voltage (code + LV)

Versione dimmerabile / Dimmable version

● CO - corten





# STAMP POST

Accessori / Accessories



## PIASTRE TIRAFONDI / PLATES WITH ANCHORING SET



code 5391



code 5392

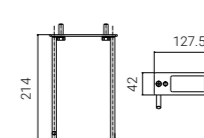

code 5391

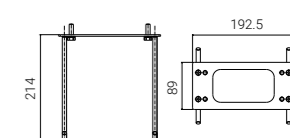

code 5392

Code	Description	Ref. to
5391	Piastra inox con tirafondi per ancoraggio al terreno / Stainless steel plate with ground anchoring set	code 5371 code 5372
5392		code 5381 code 5382 code 5383 code 5384

## GIUNTI STAGNI / WATERPROOF CONNECTIONS



code 1941



code 1944

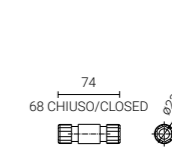

code 1941

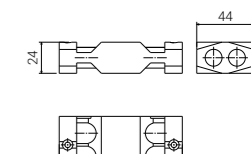

code 1944

Code	Description
1941	Connessione singola 3x2,5 mm <sup>2</sup> IP68 / Single connector 3x2,5 mm <sup>2</sup> IP 68
1944	Connessione fino a 4 uscite 3x2,5 mm <sup>2</sup> IP68 (basato su gel siliconico bicomponente) / Up to 4 outputs connector 3x2,5 mm <sup>2</sup> , based on two-component silicone gel

## STAMP VETRO / GLASS

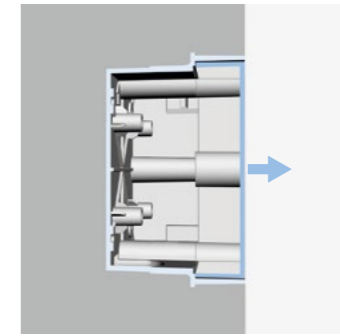
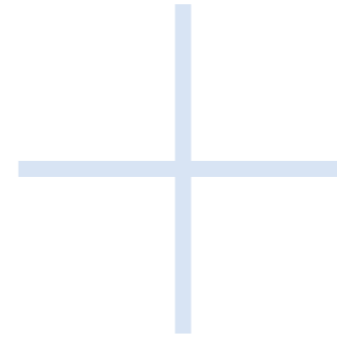

### Incasso totale a filo muro

Le controcasse sono fornite con un robusto coperchio di protezione e permettono di ottenere una reale ed effettiva sporgenza zero.

### Wall flush installation

The backboxes are supplied with a robust protection cover and allow to obtain a real and effective zero protrusion.



### Estrazione con ventosa

Agevole estrazione del corpo lampada con ventosa in dotazione.

### Removable by the sucker

Easy luminaire extraction by the sucker supplied.



### Versione su palo

Disponibile in due altezze; fornita con spezzone di cavo in bassa tensione.

### Post version

Available in two heights; supplied with low voltage cable.

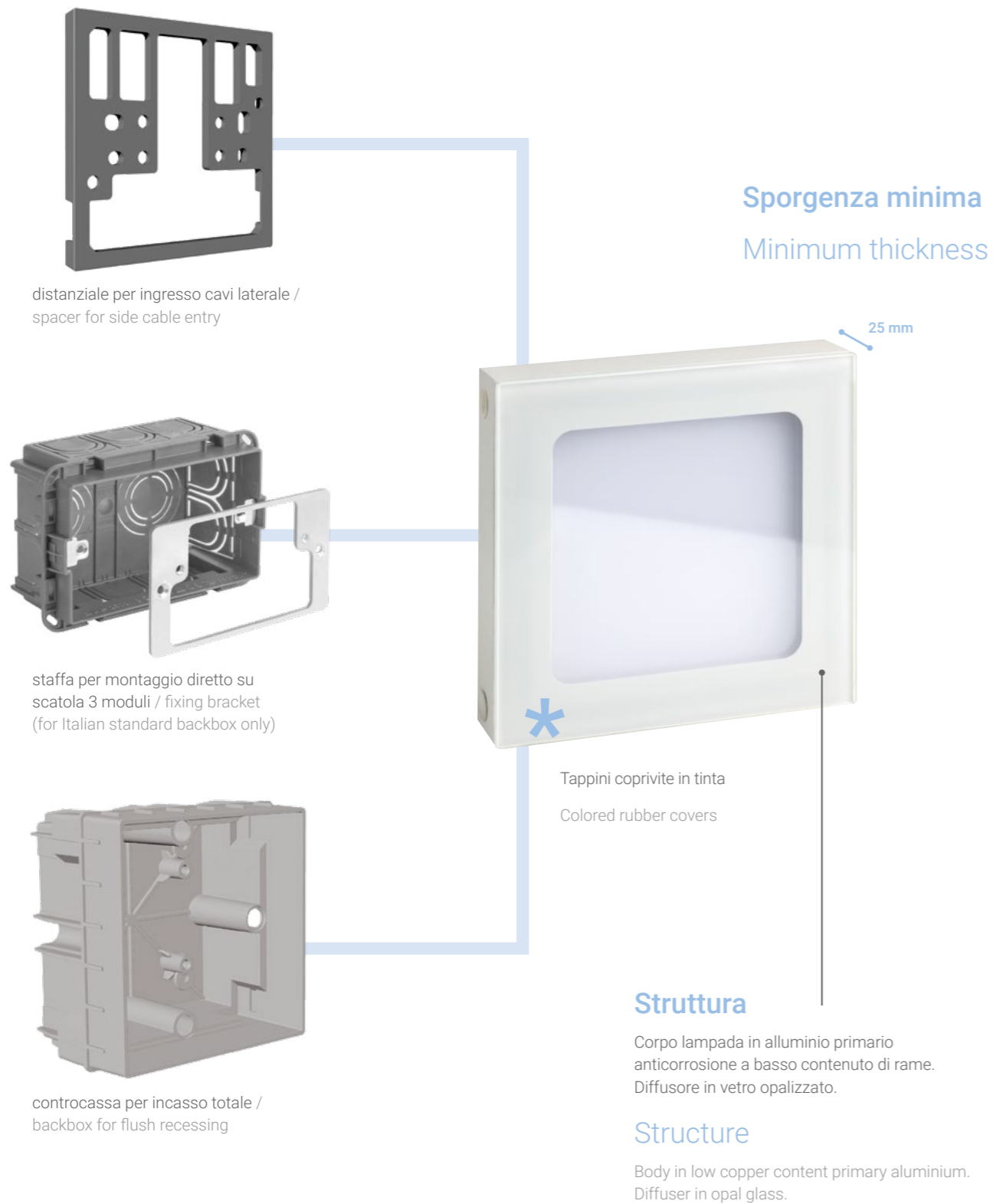

# STAMP VETRO / GLASS

Lampada segnapasso / Steplight fitting



## LAMPADA / LUMINAIRE

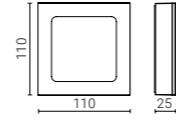

Code	
5331	<ul style="list-style-type: none"> <li><span style="display: inline-block; width: 10px; height: 10px; background-color: black; border-radius: 50%; margin-right: 5px;"></span> AN - anthracite</li> <li><span style="display: inline-block; width: 10px; height: 10px; background-color: grey; border-radius: 50%; margin-right: 5px;"></span> AG - aluminium grey</li> <li><span style="display: inline-block; width: 10px; height: 10px; background-color: white; border-radius: 50%; margin-right: 5px; border: 1px solid black;"></span> BI - white</li> </ul>
	3K - 3000K 4K - 4000K

Lamp	W	Lm LED	Real Lm	Optic
LED	6	698	302	diffuse

Driver esterno non compreso / Remote driver to be ordered separately (page 76)



# STAMP POST VETRO / POST GLASS

Pali / Posts

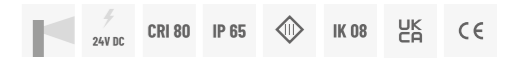

## PALI / POSTS H 300-600

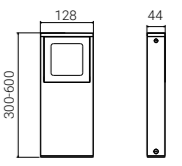

Code	
5374	<ul style="list-style-type: none"> <li><span style="display: inline-block; width: 10px; height: 10px; background-color: black; border-radius: 50%; margin-right: 5px;"></span> AN - anthracite</li> <li><span style="display: inline-block; width: 10px; height: 10px; background-color: grey; border-radius: 50%; margin-right: 5px;"></span> AG - aluminium grey</li> <li><span style="display: inline-block; width: 10px; height: 10px; background-color: white; border-radius: 50%; margin-right: 5px; border: 1px solid black;"></span> BI - white</li> </ul>
	3K - 3000K 4K - 4000K

H	Lamp	W	Lm LED	Real Lm	Optic
300 mm	LED	6	698	302	diffuse
600 mm					

Pali in alluminio completi di apparecchio e cavo precablato / Posts in aluminium, fitting and pre-wired cable included

Driver esterno non compreso / Remote driver to be ordered separately (page 76)

## PIASTRA TIRAFONDI / PLATE WITH ANCHORING SET

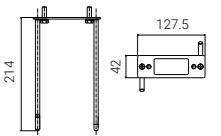

Code	Description
5391	Piastra inox con tirafondi per ancoraggio al terreno / Stainless steel plate with ground anchoring set



# STAMP VETRO / GLASS

Accessori / Accessories



## ALIMENTATORI 24V DC / 24V DC CONTROL GEARS

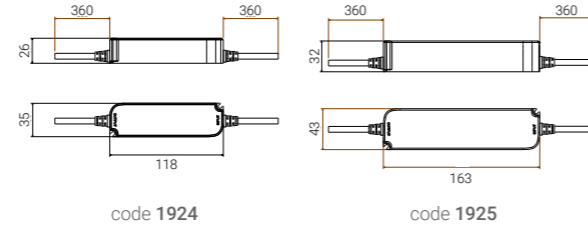

Code	W	Description
1924	24	INPUT 220-240 V - OUTPUT 24V DC
1925	60	

1924 controlla da 1 a 3 apparecchi STAMP VETRO / controls from 1 to 3 luminaires STAMP GLASS

1925 controlla da 4 a 9 apparecchi STAMP VETRO / controls from 4 to 9 luminaires STAMP GLASS

## DISTANZIALE / SPACER

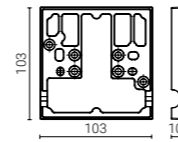

Code	Description
5351	Distanziale per ingresso cavi laterale / Spacer for side cable entry

# STAMP VETRO / GLASS

Accessori / Accessories



## CONTROCASSA / BACKBOX

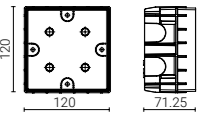
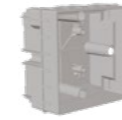

Code	Description
5358	Controcassa per incasso totale, completa di coperchio / Backbox for wall flush installation, complete with cover

## STAFFA PER SCATOLA 3 MOD. / FIXING BRACKET

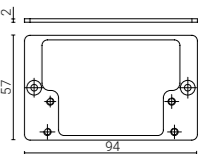

Code	Description
5360	Staffa per fissaggio a sporgere su cassetta 3 moduli standard / Fixing bracket (for Italian standard backbox only)

## STAMP LUCE LATERALE / SIDE LIGHT

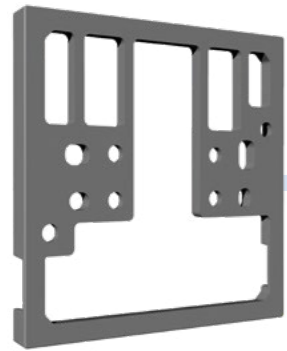
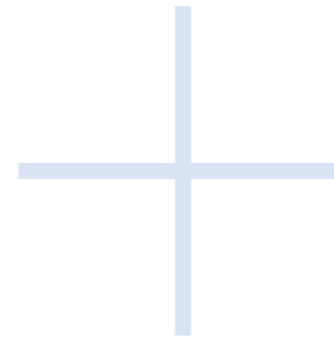

distanziale per ingresso cavi laterale /  
spacer for side cable entry

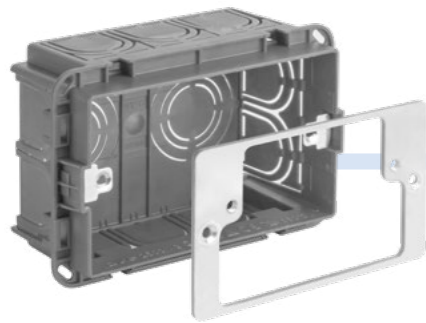

staffa per montaggio diretto su  
scatola 3 moduli / fixing bracket  
(for Italian standard backbox only)



1, 2 o 4 finestre  
1, 2 or 4 windows

### Struttura

Corpo lampada in alluminio primario anticorrosione a basso contenuto di rame.  
Diffusori in policarbonato anti UV.

### Structure

Body in low copper content primary aluminium.  
Diffusers in UV resistant polycarbonate.



### Sporgenza minima

L'accurato design e la scelta della componentistica permettono uno spessore contenuto di soli 25,5 mm per tutti le versioni.

### Minimum thickness

The accurate design and the choice of components enable to obtain a 25,5 mm minimum protrusion for all versions.



### Tappini coprivite in tinta

Colored rubber covers

# STAMP LUCE LATERALE / SIDE LIGHT

Segnapasso e effetti a parete / Steplight fitting and wall effects



## LAMPADE / LUMINAIRES



code 5335 1 light



code 5336 2 lights



code 5337 4 lights

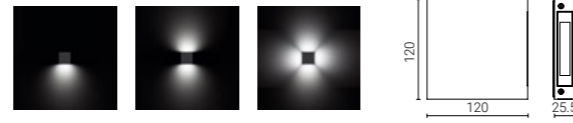

### Code

5335	● AN - anthracite	27K - 2700K
5336	● AG - aluminium grey	3K - 3000K
5337	○ BI - white	4K - 4000K

Modulo LED a tensione di rete, compatibile con dimmer a taglio di fase / Mains voltage LED module, compatible with most phase-cut dimmers

### Lamp W Lm LED Real Lm Optic

LED	4	460	250	diffuse
	8 (2x4)	920	500	
	8 (4x2)	920	500	

Su richiesta / On request

24V low voltage (code + 24V)

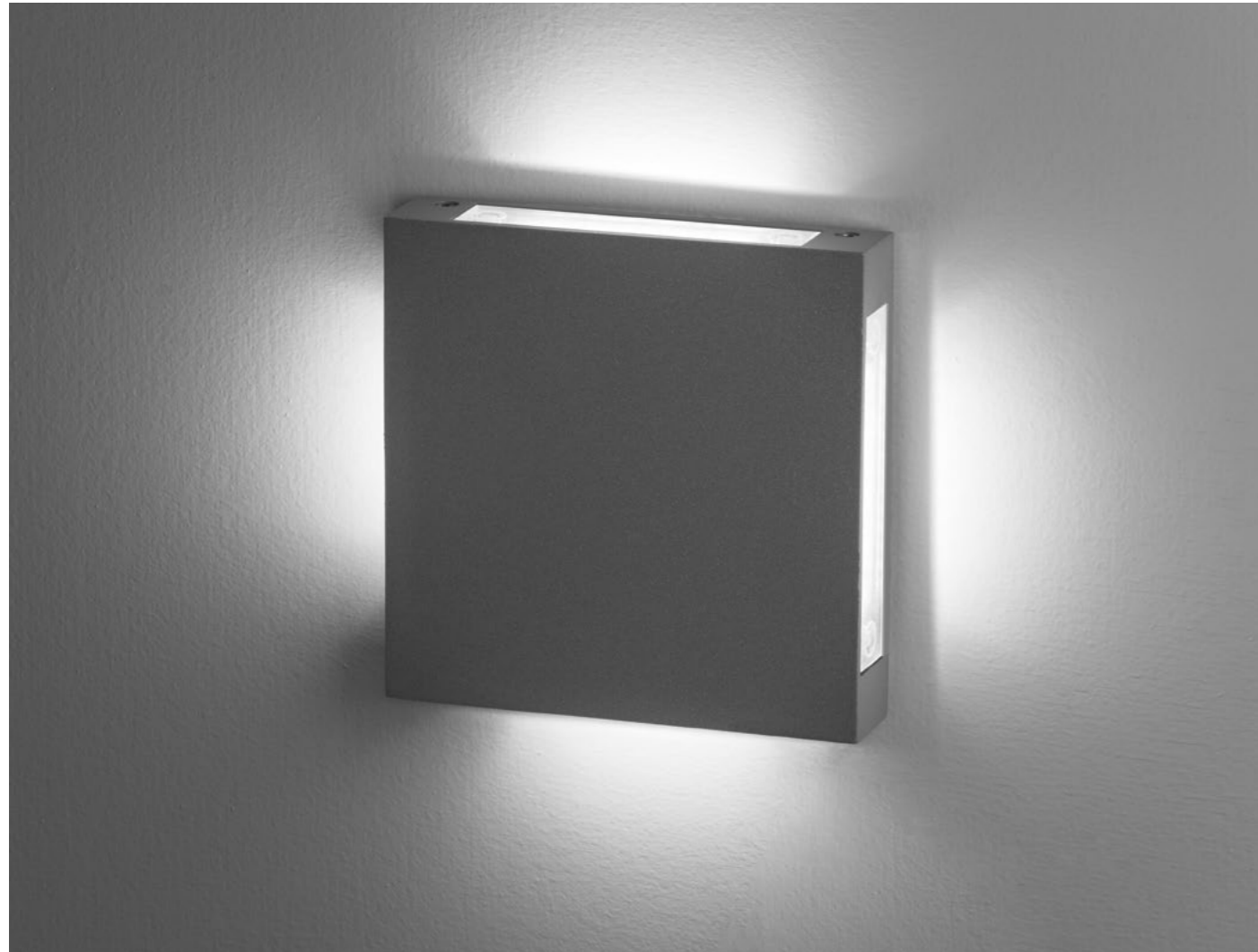

# STAMP LUCE LATERALE / SIDE LIGHT

Accessori / Accessories



## DISTANZIALE / SPACER

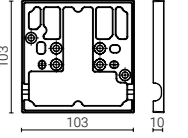

### Code

5351	Distanziale per ingresso cavi laterale / Spacer for side cable entry
------	--

### Description

## STAFFA PER SCATOLA 3 MOD. / FIXING BRACKET

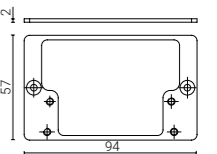

### Code

5360	Staffa per fissaggio a sporgere su cassetta 3 moduli standard / Fixing bracket (for Italian standard backbox only)
------	--

### Description