

CLOCK



Un piccolo proiettore circolare dal design essenziale e di carattere, CLOCK è uno spotlight versatile e preciso. Spessore contenuto ed elegante orientabilità, con le sue due dimensioni offre grande qualità illuminotecnica, grazie ai performanti LED ed alle ottiche accuratamente studiate per permettere svariate modalità di impiego del flusso luminoso.

Gli accessori a corredo incrementano le tipologie di installazione ed il comfort visivo di CLOCK con stile - soluzioni puntuali per un'illuminazione d'accento scenografico e vibrante.

A small circular projector with an essential design and character, CLOCK is a versatile and precise spotlight. Low thickness and elegant adjustability, with its two dimensions it offers great lighting quality, thanks to the high-performance LEDs and specific designed optics to allow various ways of using the luminous flux.

The accessories supplied increase the types of installation and the visual comfort of CLOCK with style - punctual solutions for scenographic and vibrant accent lighting.

SPOTLIGHT

CLOCK
Ø 80CLOCK
Ø 120

CLOCK

Spessore ridotto

Lo spessore di soli 36 mm per i due diametri consente un inserimento non invasivo negli ambienti esterni.

Reduced thickness

Its 36 mm thickness for both diameters allows to fix CLOCK discreetly in outdoor settings.

Il corpo in alluminio ruota intorno al perno di fissaggio per facilitare l'orientamento sul piano verticale. Il blocco è garantito da una vite 8MA. Due asole sulla base consentono l'orientamento orizzontale $\pm 40^\circ$.

The aluminium body rotates around the locking pin on the vertical surface to easily adjust its direction. An 8MA screw locks it in place. Two eyelets on the base allow for a $\pm 40^\circ$ horizontal adjustment.



Cablaggio stagno

CLOCK è ermeticamente chiuso con resina bicomponente e fornito con 1,5 m di cavo interrabile H05RN-F. Il cavo può passare nell'apposito foro della basetta del braccio.

- Pressacavo in ottone
- Resinatura Acquastop
- Cavo antistrappo

Watertight wiring

CLOCK is hermetically sealed with a two-component resin and provided with an 1,5 m H05RN-F cable. The cable can pass through a special hole in the base of the arm.

- Brass cable gland
- Aquastop Resin Finish
- Anti-tear cable

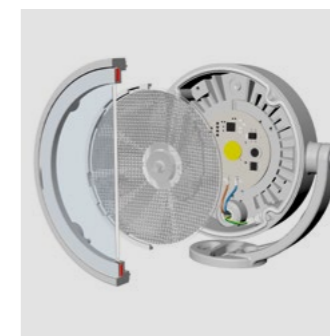
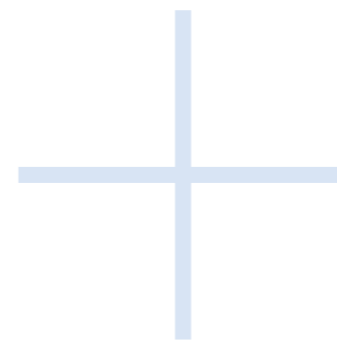

Vetro sigillato

Il vetro frontale temprato trasparente ultrawhite è sigillato alla cornice di chiusura per consentire la massima tenuta.

Sealed glass

The front tempered ultrawhite clear glass is sealed to the frame for a perfect watertight.



Steli

Steli predisposti per passaggio cavi grazie ad apposite asole.

Stems

Stems suitable for cable entry thanks to dedicated slots.



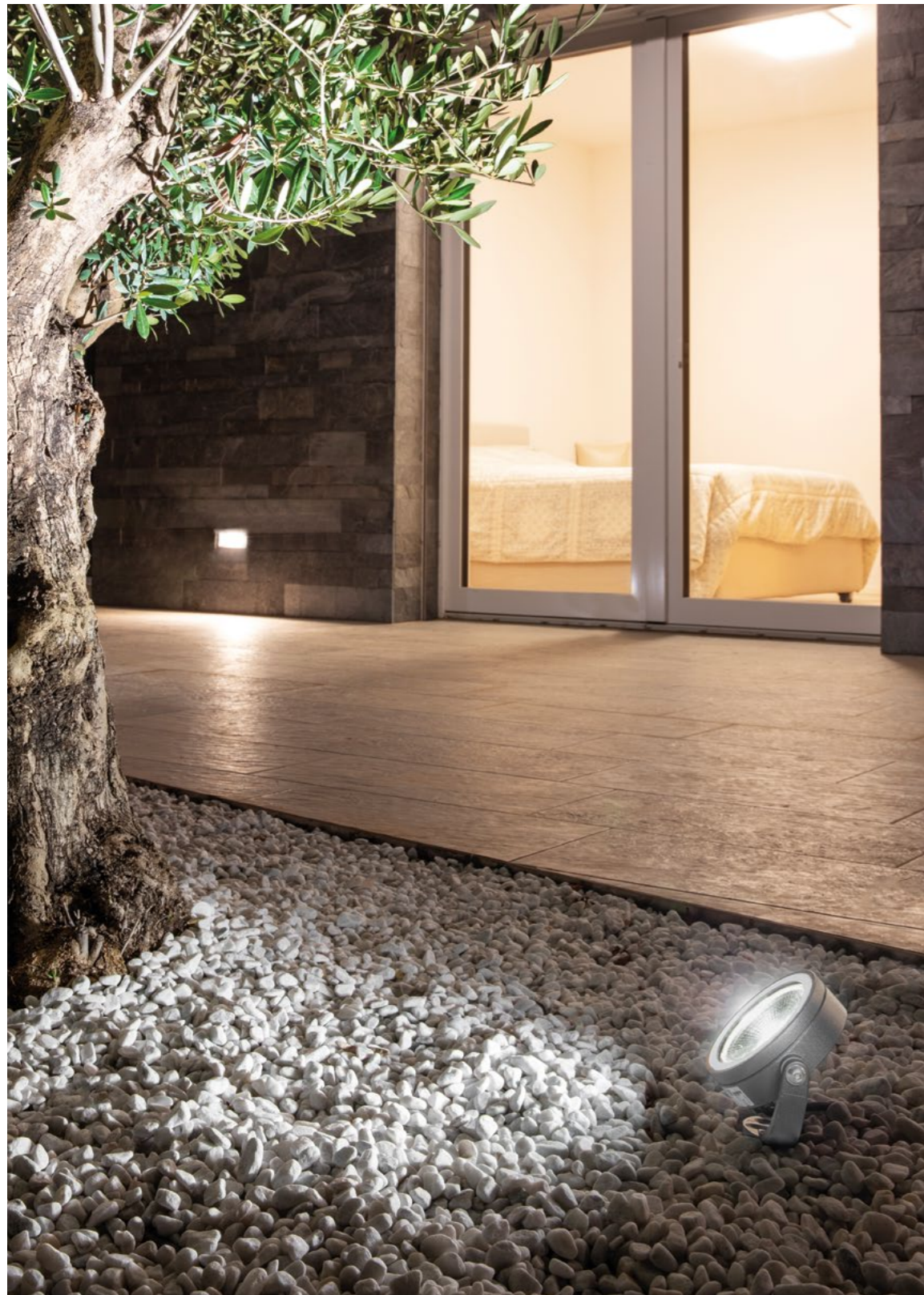

CLOCK

Spot / Spotlight



CLOCK Ø 80 mm

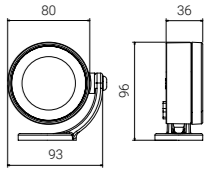

	Code	
4661	AN - anthracite	27K - 2700K
	AG - aluminium grey	3K - 3000K
	VE - green	4K - 4000K

Lamp	W	Lm LED	Real Lm	Optic
LED	4	460	290	40°

Ottiche opzionali / Optional optics 12° (code + 12), 90° (code + 90)

Fornita con 1,5 m di cavo interrabile / 1,5 m buriabile cable included

Modulo LED a tensione di rete, compatibile con dimmer a taglio di fase / Mains voltage LED module, compatible with most phase-cut dimmers

Versione RGBW (vedi capitolo dedicato) / RGBW version (see related chapter)

Su richiesta / On request

24V low voltage, cable L 20 cm (code + 24V)

Lunghezza cavo 7 m / 7 m cable length (code + MT7)

BI - white CO - corten BR - bronze

CLOCK Ø 120 mm

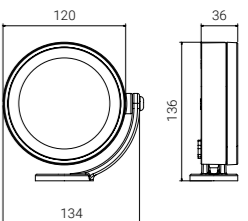

	Code	
4664	AN - anthracite	27K - 2700K
	AG - aluminium grey	3K - 3000K
4665	VE - green	4K - 4000K

Lamp	W	Lm LED	Real Lm	Optic
LED	10	1100	750	40°
	15	1575	1050	

Ottiche opzionali / Optional optics 12° (code + 12), 90° (code + 90)

Fornite con 1,5 m di cavo interrabile / 1,5 m buriabile cable included

Modulo LED a tensione di rete, compatibile con dimmer a taglio di fase / Mains voltage LED module, compatible with most phase-cut dimmers

Versione RGBW (vedi capitolo dedicato) / RGBW version (see related chapter)

Su richiesta / On request

24V low voltage, cable L 20 cm (code + 24V)

Lunghezza cavo 7 m / 7 m cable length (code + MT7)

Ottica a nido d'ape / Honeycomb optic 10° (code + HC)

BI - white CO - corten BR - bronze

CLOCK

Accessori / Accessories



VISIERA / SHIELD

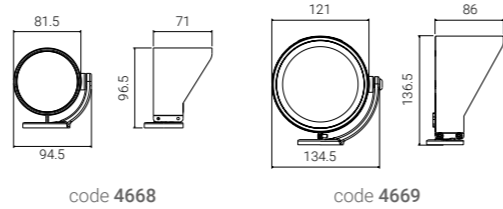

Code	Description	Ref. to
4668	Visiera in acciaio inox verniciato / Shield in painted stainless steel	code 4661
4669		code 4664
		code 4665

GIUNTI STAGNI / WATERPROOF CONNECTIONS

IP 68



code 1941



code 1942



code 1941



code 1942

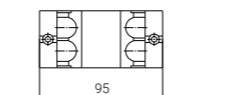
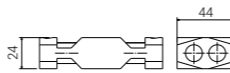
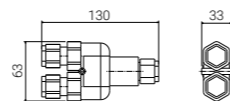

code 1944

Code	Description
1941	Connessione singola 3x2,5 mm ² IP68 / Single connector 3x2,5 mm ² IP 68
1942	Connessione entra-esce 3x2,5 mm ² IP68 / Through wiring connector 3x2,5 mm ² IP 68
1944	Connessione fino a 4 uscite 3x2,5 mm ² IP68 (basato su gel siliconico bicomponente) / Up to 4 outputs connector 3x2,5 mm ² IP 68, based on two-component silicone gel

CLOCK

Accessori / Accessories



PICCHETTO / SPIKE



Code	Description	Ref. to
4691	Picchetto da giardino in policarbonato / Garden spike in polycarbonate	code 4661
		code 4664
		code 4665

Altezza da terra consigliata: 10 cm come da normativa / Recommended height above ground: 10 cm in compliance with regulations

Il cavo può passare nell'apposito foro della basetta e nella struttura del picchetto / The cable can pass through a special hole in the base and through the structure of the spike

BRACCIO A MURO / WALL ARM

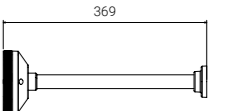

Code	Description	Ref. to
4692	Braccio in alluminio / Aluminium arm	code 4661
		code 4664
		code 4665

Cablaggio interno alla basetta; cablaggio esterno per versioni RGBW / Internal terminal block; external wiring for RGBW versions

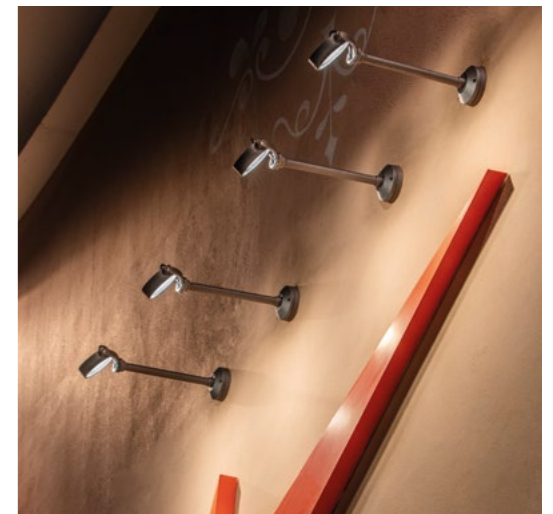



CLOCK

Accessori / Accessories

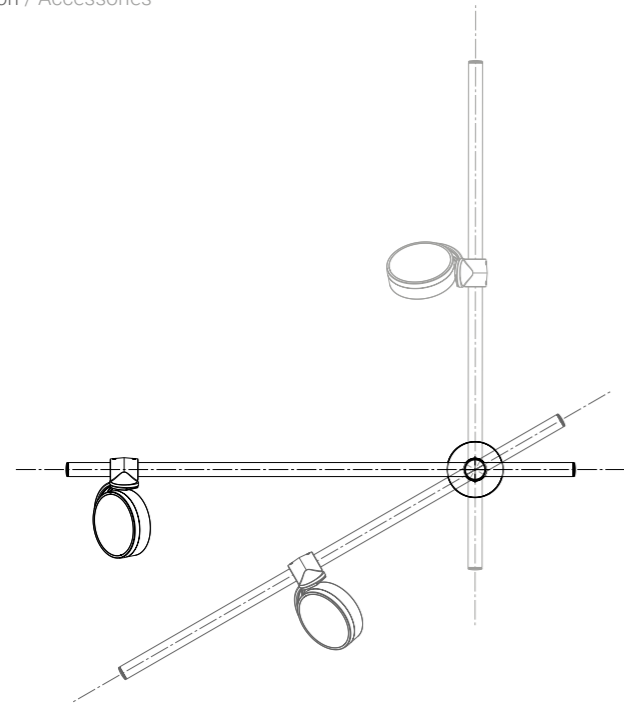

La combinazione di supporto a muro, steli, raccordi e apparecchi CLOCK consente molteplici soluzioni applicative anche con un unico punto luce disponibile.

The combination of wall support, stems, joints and CLOCK luminaires allows multiple applications even with a single light point available.

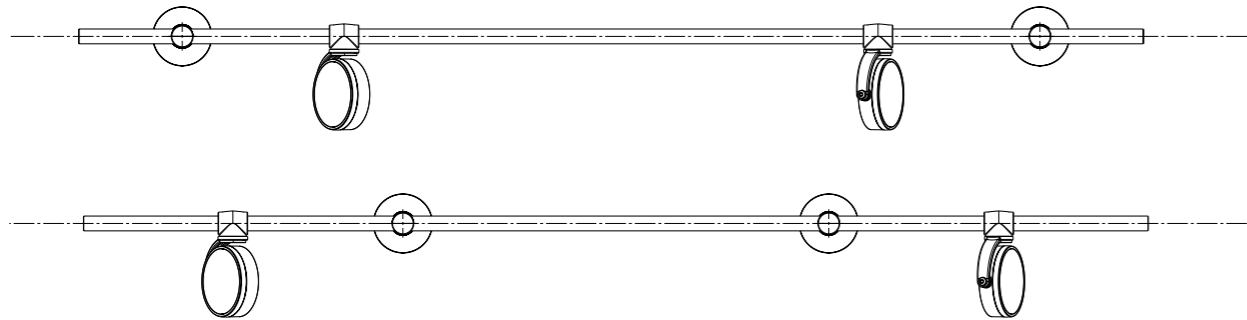

CLOCK

Accessori / Accessories



STELI A MURO / WALL STEMS



code 4681



code 4695

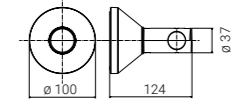

code 4681

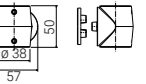

code 4695



code 4682

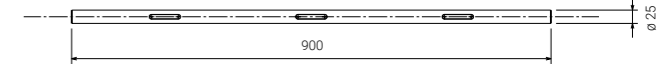

code 4682



code 4683

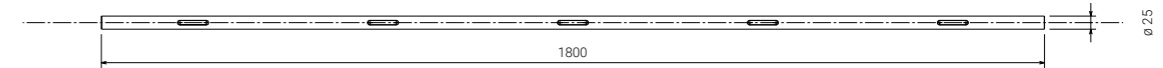

code 4683

Code	Description
4695	Raccordo scorrevole in alluminio pressofuso con relativa piastrina di fissaggio / Adjustable joint in die-cast aluminium with related fixing plate
4682	Stelo a muro L 900 mm (3 asole) in alluminio estruso / Wall stem L 900 mm (3 slots) in extruded aluminium
4683	Stelo a muro L 1800 mm (5 asole) in alluminio estruso / Wall stem L 1800 mm (5 slots) in extruded aluminium
4681	Supporto a muro in alluminio pressofuso / Wall support in die-cast aluminium

4682, 4683 Max 2 cavi all'interno dello stelo a muro /
Max. 2 cables inside the wall stem

4681 Cablaggio interno alla basetta; cablaggio esterno per versioni RGBW /
Internal terminal block; external wiring for RGBW versions

CLOCK

Accessori / Accessories



CLOCK

Accessori / Accessories

UK
CA
CE

STELI / STEMS

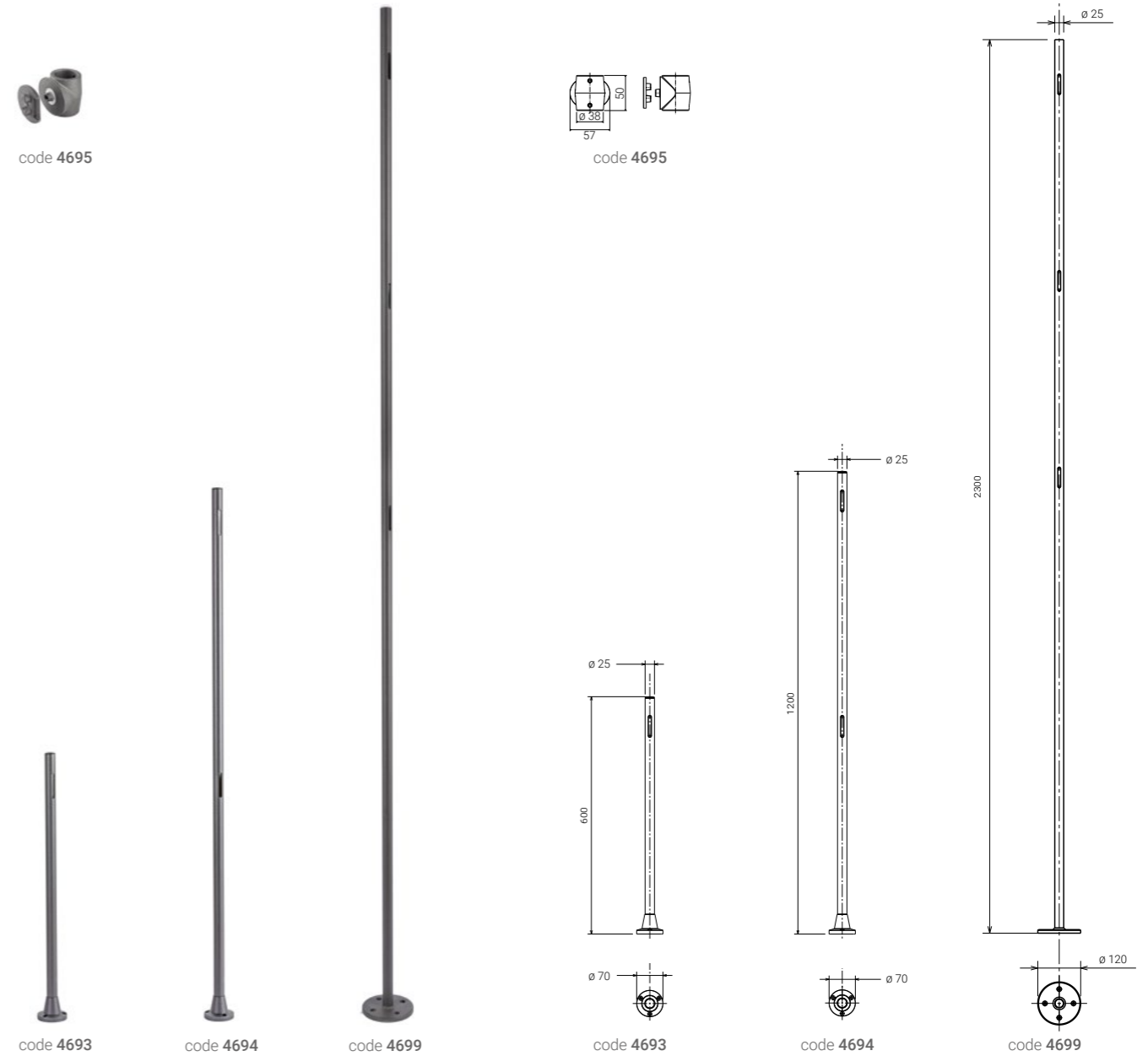

Code	Description
4693	Stelo H 600 mm (1 asola) in alluminio estruso, base in alluminio pressofuso / Stem H 600 mm (1 slot) in extruded aluminium, base in die-cast aluminium
4694	Stelo H 1200 mm (2 asole) in alluminio estruso, base in alluminio pressofuso / Stem H 1200 mm (2 slots) in extruded aluminium, base in die-cast aluminium
4699	Stelo H 2300 mm (3 asole) in acciaio, comprensivo di base / Stem H 2300 mm (3 slots) in steel, complete with base
4695	Raccordo scorrevole in alluminio pressofuso con relativa piastrina di fissaggio / Adjustable joint in die-cast aluminium with related fixing plate

4693, 4694 Max 2 cavi all'interno dello stelo / Max. 2 cables inside the stem

4699 Max 3 cavi all'interno dello stelo / Max. 3 cables inside the stem

4699 Si consiglia apparecchio CLOCK con cavo 7 m / CLOCK luminaire with 7 m cable is recommended

4694 Da montare obbligatoriamente con piastra 4697 / To be mandatorily installed with plate 4697

Su richiesta / On request

CO - corten BR - bronze

CLOCK

Accessori / Accessories

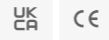

PICCHETTO / SPIKE



Code	Description	Ref. to
4696	Picchetto in policarbonato con piastra in acciaio inox AISI 304 / Spike in polycarbonate with plate in AISI 304 stainless steel	code 4693

PIASTRE TIRAFONDI / PLATES WITH ANCHORING SET



code 4697



code 5538

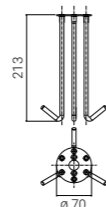

code 4697

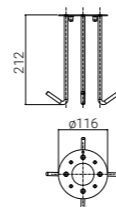

code 5538

Code	Description	Ref. to
4697	Piastra in acciaio inox AISI 304 con 3 tirafondi di ancoraggio / Plate in AISI 304 stainless steel with 3 ground anchors	code 4693 code 4694
5538	Piastra in acciaio inox AISI 304 con 4 tirafondi di ancoraggio / Plate in AISI 304 stainless steel with 4 ground anchors	code 4699

CASSAFORMA / IN-GROUND BOX

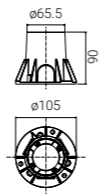

Code	Description	Ref. to
4698	Cassaforma per cablaggio interrato in tecnopolimero con anello in alluminio per fissaggio viti / In-ground box in technopolymer with aluminium ring to fix the screws	code 4693 code 4694

Accessorio opzionale per cablaggio stagno / Optional accessory for waterproof wiring (code 1941)

