

IANUS



La forma pura del bollard cilindrico viene intagliata in maniera scultorea e immediata per lasciar scaturire la luce. E la luce determina l'angolo del taglio e le proporzioni dell'intera composizione, per esprimersi al massimo e con eleganza.

IANUS è proposto da Goccia Illuminazione in biemissione o monodirezionale, con due diametri e diverse altezze, nelle resistenti e pregiate finiture.

La tecnologia ad alta efficienza delle sorgenti luminose si presta per molteplici tipi di installazione e versioni, fino a quella da arredo urbano IANUS URBAN, con le ottiche dedicate per l'ottimizzazione del flusso luminoso. Questa vocazione tecnica di grande attenzione all'effetto di luce mirato ed efficace rende IANUS uno strumento preciso per il progetto illuminotecnico di contesti architettonici privati residenziali e pubblici urbani.

The pure form of the cylindrical bollard is crafted in a sculptural and immediate way to let the light flow. And the light determines the angle of the cut and the proportions of the entire composition, to the maximum expression with elegance.

IANUS is proposed by Goccia Illuminazione in bi-emission or unidirectional, with two diameters and different heights, in resistant and precious finishes.

The high-efficiency technology of the light sources is suitable for multiple types of installation and versions, up to the IANUS URBAN street furniture, with dedicated optics for optimizing the luminous flux. This technical vocation of great attention to the targeted and effective light effect makes IANUS a precise tool for the lighting design of private residential and urban public architectural contexts.

POLES



IANUS 60



IANUS 120

URBAN LIGHTING



IANUS URBAN

IANUS 60

Struttura

- Testa-palo in lega di alluminio primario a basso tenore di rame
- LED schermato all'interno del diffusore
- Driver incorporato nel testa-palo

Structure

- Pole-top in primary low-copper grade aluminium alloy
- Shielded LED inside the diffuser
- Driver incorporated in the pole-top

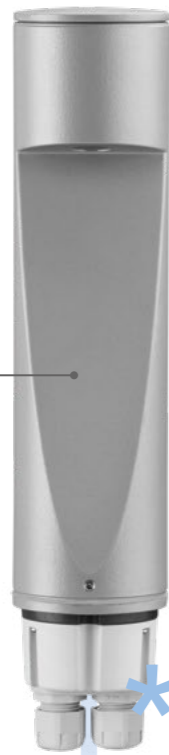

Il testa-palo è dotato di due pressacavi M16 per consentire l'alimentazione passante.

The pole-top is equipped with two M16 cable glands to allow through wiring.

Pali

Pali lisci in alluminio estruso.
Disponibili in 2 altezze: 375 mm e 800 mm.

Poles

Smooth poles in extruded aluminum.
Available in 2 heights: 375 mm and 800 mm.

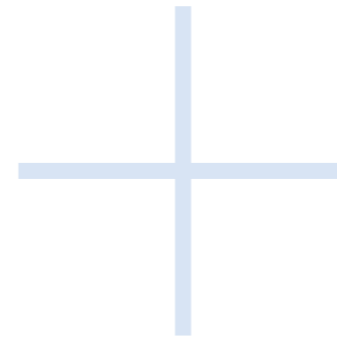

Purezza della forma

Il volume cilindrico pulito di IANUS 60 si esprime nel taglio della sorgente luminosa, per esaltare l'effetto del piano inclinato in un equilibrio di luci ed ombre. L'accuratezza del progetto permette di ottenerlo identico in modo speculare nella versione in biemissione.

Purity of shape

The clean cylindrical volume of IANUS 60 is expressed in the cut of the light source, to enhance the effect of the inclined plane in a balance of light and shadow. The accuracy of the project allows it to be identical in the double emission version specularly.



Adattatore per pali Ø 60 mm

Gli apparecchi IANUS 60 possono essere installati e fissati mediante uno speciale raccordo anche su qualsiasi palo di mercato di Ø 60 mm.

Adaptor for Ø 60 mm poles

The IANUS 60 luminaires can also be installed and fixed by means of a special adaptor on any standard Ø 60 mm pole.

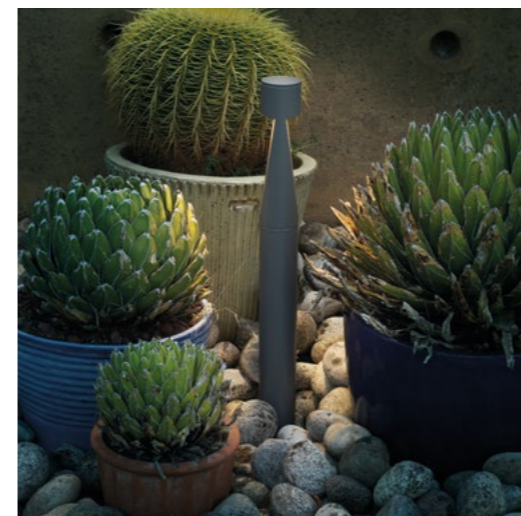

IANUS 60

Pali da giardino / Garden poles



CORPI LAMPADA / LIGHT BODIES Ø 60 mm

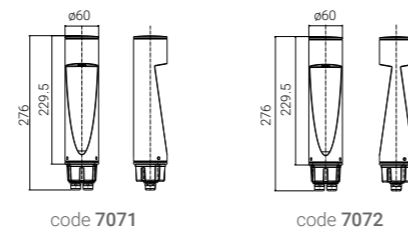

Code		
7071	● AN - anthracite	27K - 2700K 3K - 3000K
7072	● AG - aluminium grey	4K - 4000K

Lamp	W	Lm LED	Real Lm	Optic
LED	4,6	430	115	diffuse
	8	860	230	

Su richiesta / On request

7071 12-24V low voltage (code + LV)

● BR - bronze

IANUS 60

Accessori / Accessories



PALI / POLES



Code	H	Description
3401	375 mm	Palo liscio in alluminio estruso, comprensivo di basetta interna di ancoraggio in alluminio pressofuso / Smooth pole in extruded aluminium with incorporated internal fixing base in die-cast aluminium
3402	800 mm	

Si raccomanda l'installazione con piastra cod. 5518 / Installation with anchor plate code 5518 is recommended

Versione con base esterna / External ground fixing base version (page 173)



Su richiesta / On request

● BR - bronze



PIASTRA TIRAFONDI / PLATE WITH ANCHORING SET

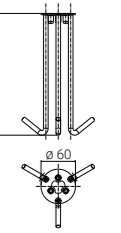

Code	Description
5518	Piastra inox con tirafondi per ancoraggio al terreno / Stainless steel plate with ground anchoring set

RACCORDO PER PALI STANDARD / ADAPTOR FOR STANDARD POLES Ø 60 mm

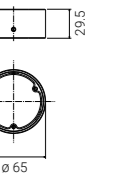

Code	Description
5506	Raccordo in alluminio primario pressofuso, adattabile a qualsiasi palo Ø 60 mm / Adaptor in die-cast primary aluminium, to be installed on any pole Ø 60 mm

IANUS 120

Struttura

- Interamente in lega di alluminio primario a basso tenore di rame
- Sorgente luminosa inserita all'interno dello schermo lenticolare in policarbonato opale fotoinciso per un'ampia e uniforme apertura della luce
- Viti di chiusura laterali in acciaio inox in tinta

Structure

- Entirely in primary low-copper grade aluminium alloy
- Light source inside the photo-etched lenticular opal diffuser for a wide and uniform light distribution
- Color matching side-locking stainless steel screws



Cablaggio stagno con spezzone di cavo in dotazione che alimenta il driver integrato. Secondo ingresso M16 disponibile per cablaggio aggiuntivo, posizionato nella parte inferiore del tappo di chiusura in tecnopolimero.

Watertight wiring through the supplied cable that powers the integrated driver. Further M16 entry for additional wiring, positioned in the lower part of the closing cap in technopolymer.

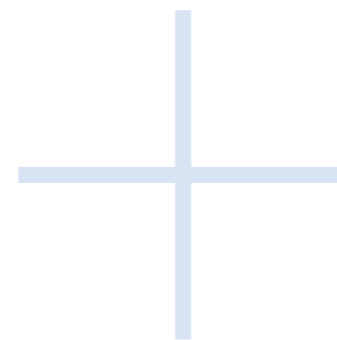

Monolitico

La semplicità della forma e delle linee pure di IANUS 120 ne conferiscono il carattere forte e di robustezza che viene concretizzato con la realizzazione tramite un unico stampo di pressofusione in lega di alluminio primario, riducendo inoltre al minimo le parti visibili.

Monolithic

The simplicity of the shape and pure lines of IANUS 120 give it a strong and robust character, which is materialized with the realization through a single die-casting mold in primary aluminum alloy, reducing the visible parts to a minimum.

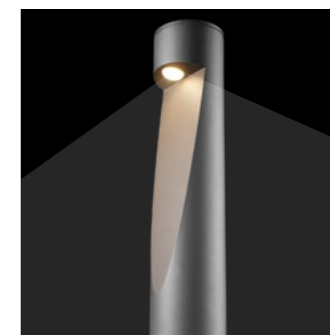

Progettato per la resa luminosa

La ricerca geometrica e delle proporzioni ha consentito l'ideale posizionamento della sorgente luminosa di IANUS 120. La particolare forma del diffusore opalizzato permette di massimizzare l'output e l'apertura della luce.

Designed for luminous performance

The research of geometry and proportions allowed the ideal positioning of the IANUS 120 light source. The particular shape of the opalized diffuser allows to maximize the output and the width of the light.



IANUS 120

Pali da giardino e arredo urbano / Garden poles and urban lighting



IANUS 120 H 600

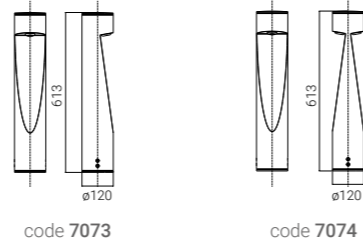

Code		
7073	● AN - anthracite	27K - 2700K 3K - 3000K
7074	● AG - aluminium grey	4K - 4000K

Lamp	W	Lm LED	Real Lm	Optic
LED	8	951	515	diffuse
	15	1902	1030	

Palo completo, cavo in dotazione / Complete fitting, cable supplied

Su richiesta / On request
Versione dimmerabile / Dimmable version
● BR - bronze

IANUS 120 H 1000

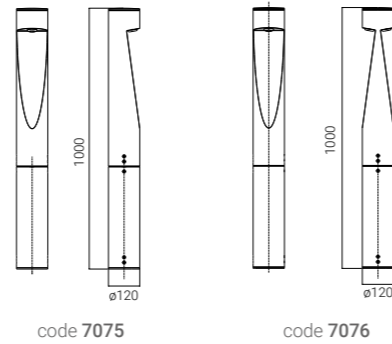
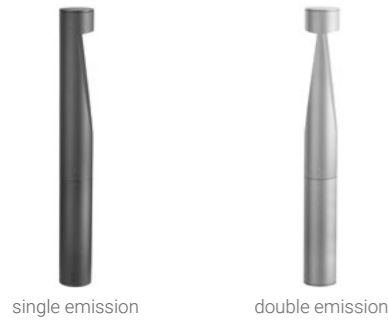

Code		
7075	● AN - anthracite	27K - 2700K 3K - 3000K
7076	● AG - aluminium grey	4K - 4000K

Lamp	W	Lm LED	Real Lm	Optic
LED	8	951	515	diffuse
	15	1902	1030	

Palo completo, cavo in dotazione / Complete fitting, cable supplied

Su richiesta / On request
Versione dimmerabile / Dimmable version
● BR - bronze

PIASTRA TIRAFONDI / PLATE WITH ANCHORING SET

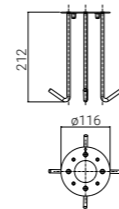

Code	Description
5538	Piastra inox con tirafondi per ancoraggio al terreno / Stainless steel plate with ground anchoring set

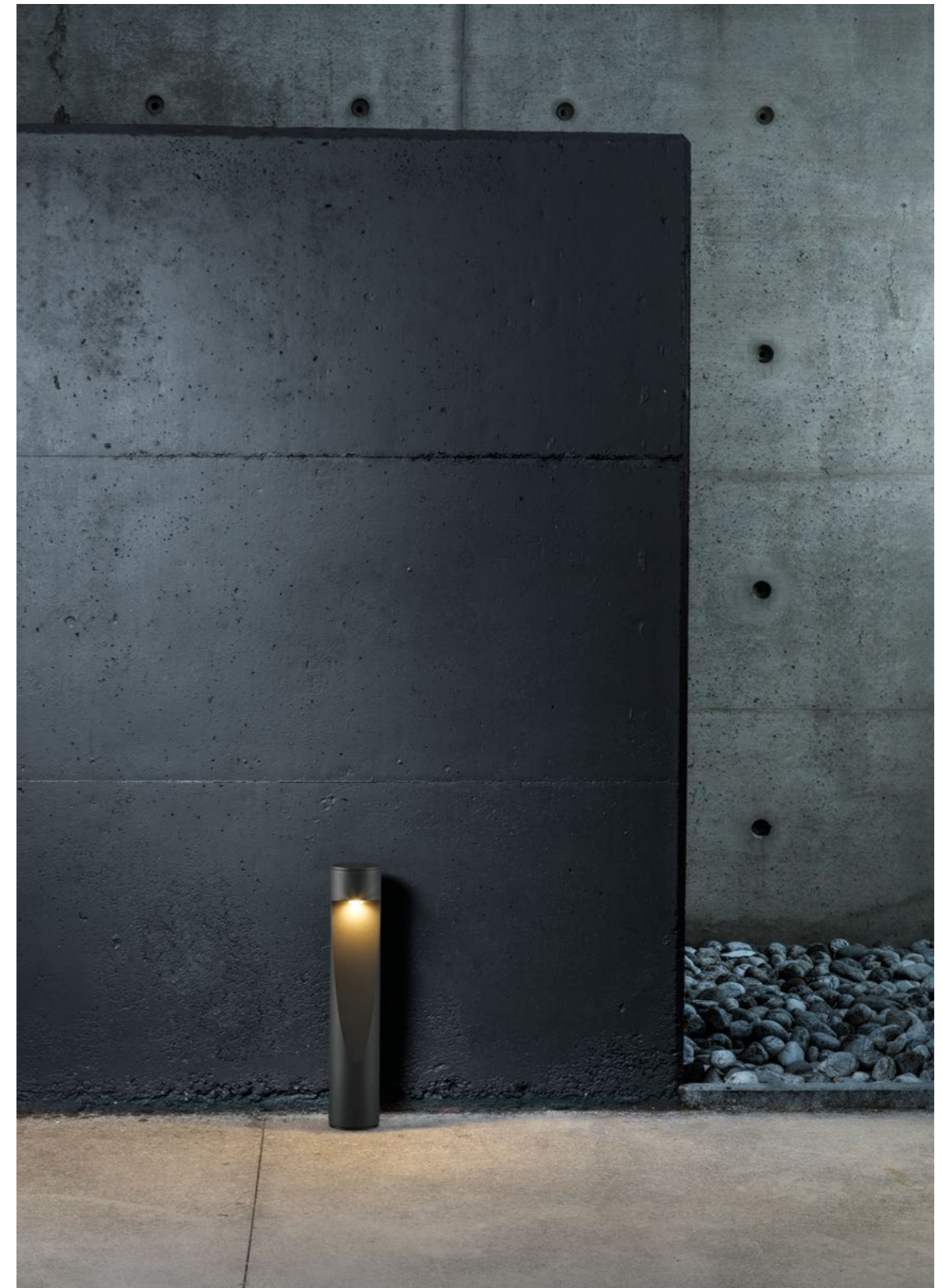



Cablaggio stagno con spezzone di cavo in dotazione che alimenta il driver integrato. Secondo ingresso M16 disponibile per cablaggio aggiuntivo, posizionato nella parte inferiore del tappo di chiusura in tecnopolimero.

Watertight wiring through the supplied cable that powers the integrated driver. Further M16 entry for additional wiring, positioned in the lower part of the closing cap in technopolymer.

Struttura

- Corpo illuminante Ø 120 mm in alluminio pressofuso a basso tenore di rame accoppiato in continuità con palo in alluminio estruso
- Sorgente luminosa recessa per accogliere ottiche dedicate
- Schermo lenticolare in policarbonato fotoinciso
- Viti di chiusura laterali in acciaio inox in tinta

Structure

- Lighting body Ø 120 mm in low-copper grade die-cast aluminium coupled in continuity with extruded aluminium pole
- Recessed light source with dedicated lenses
- Photo-etched lenticular polycarbonate diffuser
- Color matching side locking stainless steel screws

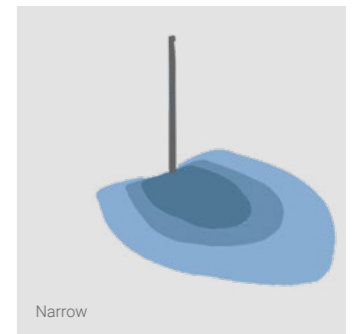
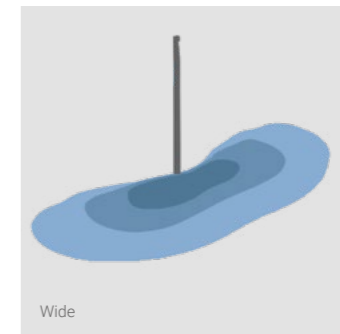
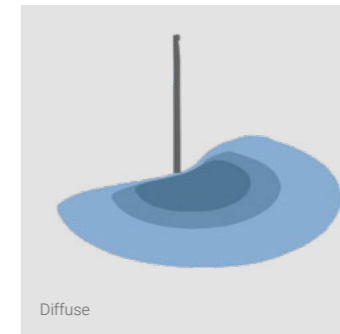
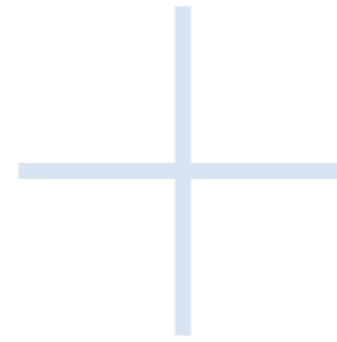

Illuminazione urbana

Per rispondere alle necessità di illuminazione cittadina e di contesti residenziali più estesi, IANUS URBAN abbina ai LED ad alto rendimento lenti e ottiche apposite per ottenere il risultato più corretto - sono disponibili fasci luminosi ad ampia diffusione e asimmetrici.

Urban lighting

To meet the needs of urban lighting and larger residential contexts, IANUS URBAN combines high-performance LEDs with special lenses and optics to obtain the best result - wide diffusion and asymmetric light beams are available.



Solidità di installazione

Abbinato al palo, IANUS URBAN nelle soluzioni mono- e bifacciali dispone di solide modalità di installazione con un'attenzione al risultato estetico, grazie all'interramento del palo o al basamento in superficie.

Solidity of installation

Combined with the pole, IANUS URBAN in single- and double-sided solutions allows solid ways of installation with a focus on the aesthetic result, thanks to the buriable pole mounting or to the surface mounting with base.

IANUS URBAN

Arredo urbano / Urban lighting



IANUS URBAN INTERRABILE / BURIABLE H 2400



single emission double emission

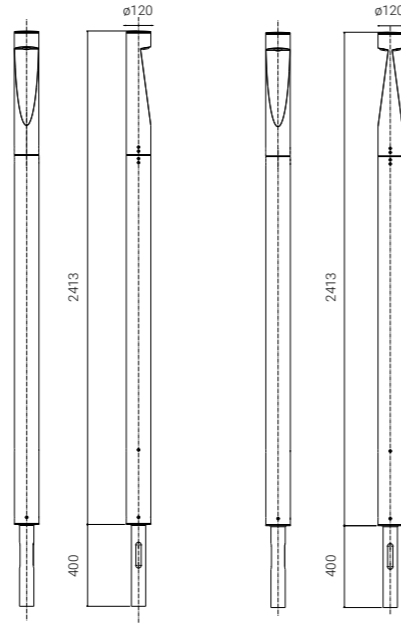

code 7081 code 7082

Code

Code	Color	Temp
7081	● AN - anthracite	27K - 2700K 3K - 3000K
7082	● AG - aluminium grey	4K - 4000K

Ottiche opzionali / Optional optics
asimmetrica / asymmetric wide (code + W), narrow (code + N)

Palo completo con ancoraggio interrabile e cavo /
Complete fitting with buriable anchoring unit and cable

Eventuale protettore di sovratensioni da ordinare separatamente / Optional SPD to
be ordered separately (page 309)

Lamp W Lm LED Real Lm Optic

Lamp	W	Lm LED	Real Lm	Optic
LED	16	1952	934	diffuse
	32	3904	1868	

Su richiesta / On request

Versione dimmerabile / Dimmable version

● BR - bronze

IANUS URBAN

Arredo urbano / Urban lighting



IANUS URBAN CON BASAMENTO / WITH BASE H 2400



single emission double emission

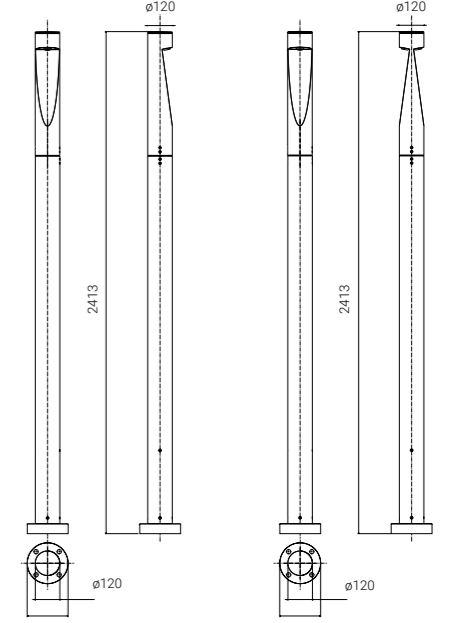

code 7083 code 7084

Code

Code	Color	Temp
7083	● AN - anthracite	27K - 2700K 3K - 3000K
7084	● AG - aluminium grey	4K - 4000K

Ottiche opzionali / Optional optics
asimmetrica / asymmetric wide (code + W), narrow (code + N)

Palo completo con basamento e cavo / Complete fitting with base and cable

Eventuale protettore di sovratensioni da ordinare separatamente / Optional SPD to
be ordered separately (page 309)

Lamp W Lm LED Real Lm Optic

Lamp	W	Lm LED	Real Lm	Optic
LED	16	1952	934	diffuse
	32	3904	1868	

Su richiesta / On request

Versione dimmerabile / Dimmable version

● BR - bronze

TIRAFONDI / ANCHORING SET

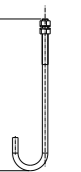

Code

5527

Description

4 tirafondi in acciaio per ancoraggio al terreno / 4 steel ground anchors

Ref. to

code 7083
code 7084

