

goccia
ILLUMINAZIONE

2023

light



DISEGNO DELLA LUCE

DESIGN OF THE LIGHT

Quando il progetto di design prende il via dall'intuizione, l'ingegnerizzazione segue il processo fino a definire l'estetica e la realizzazione - la forma segue la funzione, ma entrambe seguono la luce. E la luce è allo stesso tempo il fine ultimo e la spinta di ricerca originaria.

When the design project starts from intuition, the engineering follows the process until it defines the aesthetics and the realization - the form follows the function, but both follow the light. And light is at the same time the ultimate goal and the original drive of the research.

LUCE NELLA FORMA

LIGHT INTO THE FORM



- 5 **INDICE PER SERIE**
INDEX BY SERIES
- 6 **INDICE PER APPLICAZIONE**
INDEX BY APPLICATION
- 10 **PROFILO AZIENDALE**
COMPANY PROFILE
- 22 **PRODOTTI**
PRODUCTS
- 329 **INFORMAZIONI GENERALI**
GENERAL INFORMATION
- 336 **INDICE PER CODICE**
INDEX BY CODE

goccia
ILLUMINAZIONE

Il principio di Goccia Illuminazione è da sempre dare alla luce alloggio, protezione e libertà di espressione - questa la funzione. Trasformare un concetto in un prodotto finito risulta ogni volta una sfida entusiasmante, ricca di scelte ed impegno, sostenibile nel segno del made in Italy, per arrivare ad illuminare l'architettura, i giardini e gli spazi esterni, per portare luce alle persone che li vivono. Con questo spirito e sempre rinnovato entusiasmo, Goccia Illuminazione porta luce nella forma.

The principle of Goccia Illuminazione has always been to give a space to the light, protection and freedom of expression - this is the function. Transforming a concept into a finished product is every time an exciting challenge, full of choices and commitment, sustainable in the sign of the made in Italy, to finally illuminate architecture, gardens and outdoor spaces, to bring light to the people who live them. With this spirit and with always renewed enthusiasm, Goccia Illuminazione brings light into the form.



INDICE PER SERIE INDEX BY SERIES

- 176 CANTHARELLUS
- 184 CANTHUS
- 102 CLOCK
- 262 CORINTHIA
- 286 DOCKS
- 142 IANUS
- 206 I-DEA
- 198 I-LUX
- 190 I-MAGO
- 302 JACK
- 220 K³
- 294 KASKO
- 274 KYKLO
- 280 LUNETTE
- 268 LUX SHOWER
- 308 MARINA
- 22 PASSUM
- 116 PROTO
- 82 QUANTUM
- 316 RGBW
- 126 SERVER POINT
- 238 SMALL, MIDI, MAXI & SUPERMAXI
- 52 SQUEEZE
- 60 STAMP
- 134 STANDING
- 160 T-LUX
- 250 TRIANGOLO
- 256 VOLTO
- 212 WASH

INDICE PER APPLICAZIONE
INDEX BY APPLICATION

INCASSI A TERRA / GROUND RECESSED



PASSUM UP 24 PASSUM UP ULTRAFLAT 27 PASSUM INOX 22 PASSUM SIDEWARDS 34 PASSUM SPOT 40

CALPESTABILI DI SUPERFICIE / GROUND SURFACE MOUNTED



SQUEEZE UP 58 SQUEEZE Ø 77 56 SQUEEZE Ø 180 56

SEGNAPASSO DA INCASSO E SUPERFICIE / RECESSED AND SURFACE MOUNTED STEPLIGHT



QUANTUM 82 QUANTUM GLASS 82 PASSUM 22 SQUEEZE UP 58 SQUEEZE Ø 77 56



STAMP 62 STAMP 62 STAMP GLASS 72 STAMP SIDE LIGHT 78

PALI / POSTS



CANTHARELLUS 176 IANUS 60 144 I-MAGO 190 I-LUX 198 I-DEA 206



T-LUX OLLIE 162 IANUS 120 148 STAMP POST 68 STANDING 134 QUANTUM POST 98



STAMP POST GLASS 75 T-LUX STAN 166 CLOCK 112

ARREDO URBANO / URBAN LIGHTING



CANTHUS 184 IANUS URBAN 154 PROTO 116

INDICE PER APPLICAZIONE
INDEX BY MOUNTING

EFFETTI A PARETE / WALL EFFECTS



PARETE E SOFFITTO / WALL AND CEILING



PROIETTORI / PROJECTORS



TORRETTE MULTIFUNZIONE / GARDEN POWER POINTS



DOWNLIGHT DA INCASSO E SUPERFICIE / RECESSED AND SURFACE MOUNTED DOWNLIGHT

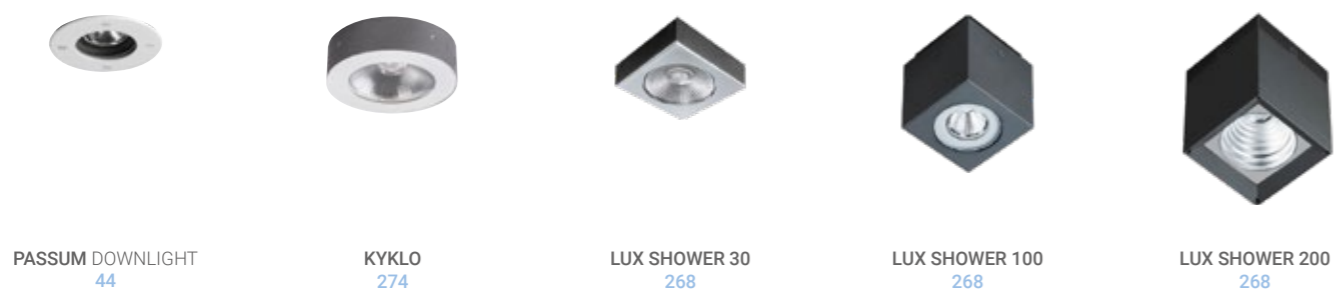

RGBW





GOCCIA ILLUMINAZIONE



Da oltre 40 anni Goccia Illuminazione realizza prodotti unici per l'illuminazione da esterno per l'Italia e per il mondo. La costante crescita concentrata sullo sviluppo di questo settore ha portato l'originariamente piccola attività industriale di Poncarale, a sud di Brescia, ad espandersi dal 1977 fino ad oggi su cinque aree produttive adiacenti, dislocate su di una superficie di capannoni e uffici di oltre 8.000 metri quadrati. La goccia, simbolo internazionale ed intuitivo della tenuta stagna nella normativa per apparecchi illuminanti all'epoca della fondazione, diede il nome e la traccia che ancora oggi seguiamo in costante evoluzione tecnica per soddisfare le esigenze dei nostri clienti e proporre nuovi percorsi nella luce.

For over 40 years Goccia Illuminazione has been producing unique products for outdoor lighting for Italy and the world. The constant growth concentrated on the development in this sector has led the originally small industrial activity in Poncarale, south of Brescia, to expand from 1977 until today on five adjacent production areas, spread over an area of warehouses and offices of over 8.000 square meters. The drop (goccia in Italian), an international and intuitive symbol of watertightness in the legislation for lighting fixtures at the time of its foundation, gave the name and the trace that we still follow in constant technical evolution to meet the needs of our customers and propose new paths in the light.



LUCE MADE IN ITALY

LIGHT MADE IN ITALY

DA OLTRE 40 ANNI PRODOTTI UNICI PER L'ILLUMINAZIONE DA ESTERNI

FOR OVER 40 YEARS
UNIQUE PRODUCTS
FOR OUTDOOR LIGHTING

goccia
ILLUMINAZIONE

1977

La serie **GOCCIA** apre la strada nell'illuminazione per esterno come plafoniera colorata e versatile.

The **GOCCIA** series leads the way in outdoor lighting as a colorful and versatile lamp.



1980

TRIANGOLO porta le innovative forme triangolari, il design caratteristico negli anni a venire.

TRIANGOLO brings the innovative triangular shape, distinctive design for years to come.



1990

KASKO e l'alluminio segnano il salto di qualità per tenuta, robustezza e finitura. E allo stesso tempo l'inventiva esplora nuovi scenari, come per **SUMMERTIME**.

KASKO and aluminum mark the breakthrough in terms of watertight, strength and finish. And at the same time creativity explores new scenarios, as for **SUMMERTIME**.



2000

Prosegue l'evoluzione tecnica e dell'illuminazione architettonica con **SMALL MIDI MAXI & SUPERMAXI** e **STRIKE**, nella prima versione LED.

The technical and architectural lighting evolution carries on with **SMALL MIDI MAXI & SUPERMAXI** and **STRIKE**, in the first LED version.



2010

La tecnologia LED più avanzata si combina col concetto di modularità: arrivano **QUANTUM** e **I-MAGO**.

The most advanced LED technology is combined with the concept of modularity: **QUANTUM** and **I-MAGO**.



2020

La gamma si arricchisce, l'innovazione e le performance crescono nel contesto consolidato di estetica, resistenza e qualità.

The range is enriched, innovation and performance grow in the consolidated context of aesthetics, resistance and quality.



NUOVE FINITURE

NEW FINISHES

Goccia Illuminazione raffina la gamma delle finiture introducendo due nuove varianti di colore come sfumature ulteriori di toni grigi chiari e scuri, ricercate per aderire in modo ancora più appagante alle forme delle nuove serie. La purezza della colorazione si unisce alla qualità, alla resistenza meccanica e alla grana raffinata dei nuovi colori ANTRACITE e GRIGIO ALLUMINIO.

Goccia Illuminazione refines the range of finishes by introducing two new color variants as further shades of light and dark grey tones, sought after to adhere in an even more satisfying way to the shapes of the new series. The purity of the coloring is combined with the quality, mechanical resistance and refined grain of the new ANTHRACITE and ALUMINUM GREY colors.

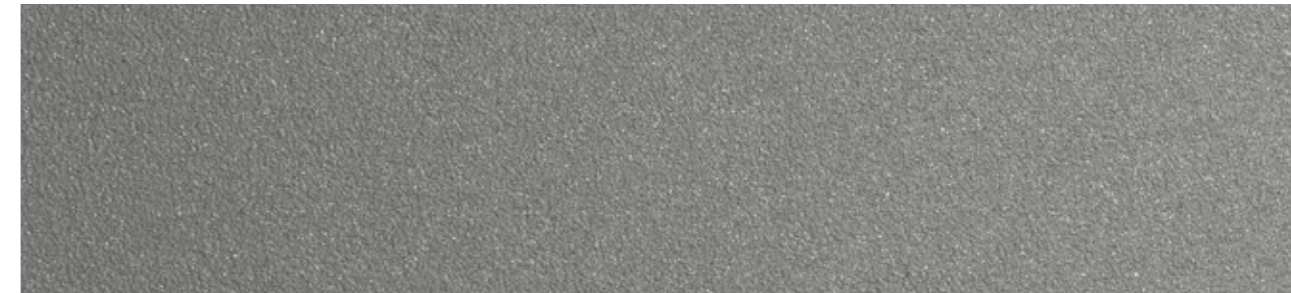
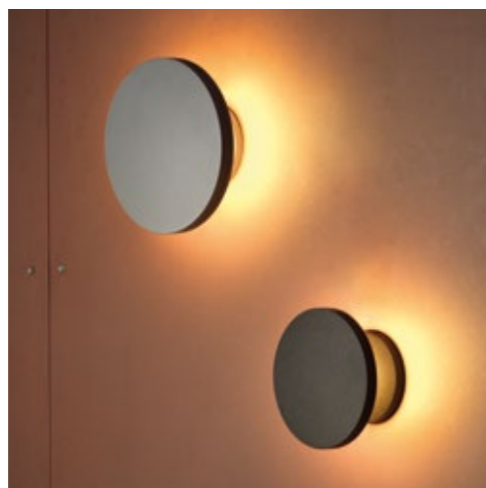

Con la stessa qualità e raffinatezza tecnica la proposta viene ampliata per incontrare il gusto sempre più attento nella scelta delle finiture degli spazi esterni. Nella mimesi o nel tono d'accento le linee delle lampade acquisiscono un carattere nuovo e di suggestione, specialmente nella luce diurna. Sviluppati per offrire un connubio cromatico nell'estetica del giardino e dell'architettura del paesaggio, sono ora disponibili i colori VERDE e BRONZO.

With the same quality and technical refinement, the proposal is expanded to meet the increasingly attentive taste in the choice of finishes for outdoor spaces. In mimesis or in the accent tone, the lines of the lamps acquire a new and suggestive character, especially in the daylight. Developed to offer a chromatic union in garden aesthetics and landscape architecture, GREEN and BRONZE colors are now available.

ACCENDERE SEMPRE NUOVI PERCORSI: UN DIALOGO NELLA LUCE

ALWAYS ENLIGHTENING NEW PATHS:
A DIALOGUE IN THE LIGHT

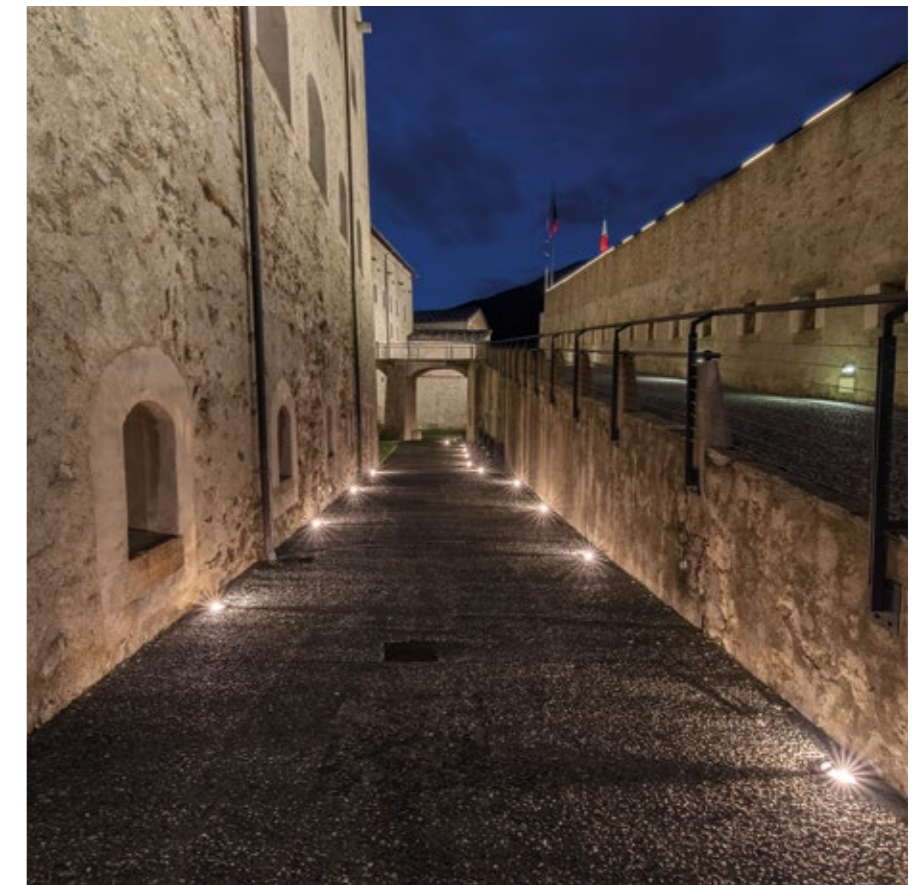

Ogni lampada che Goccia Illuminazione sviluppa trova completamento nella sua realizzazione. Da qui comincia un altro viaggio che la porta al punto dove sarà installata e accesa, un punto che a sua volta diventa nuovo completamento e destinazione: una terrazza, un sottopasso, un giardino, un viale alberato. Una lampada per l'esterno - questa la sua natura - al confine tra lo spazio chiuso e quello aperto, oppure lungo la via tra luoghi diversi. È qui che prosegue il suo viaggio, con chi in questa luce cammina, si ferma per qualche tempo, torna a casa. Questo percorso significa una attenzione continua nel tempo ad ognuna delle diverse fasi. Lo tracciamo con la passione dei colleghi in azienda, attraverso la catena di distribuzione, gli architetti, i progettisti e gli installatori. Ogni volta diverso e acceso di novità, è il percorso che ci guida in un entusiasmante dialogo con i momenti, con i luoghi e con le persone.

Each lamp that Goccia Illuminazione develops finds completion in its realization. From here begins another journey that takes it to the point where it will be installed and lit, a point which in turn becomes a new completion and destination: a terrace, an underpass, a garden, a tree-lined avenue. A lamp for the outdoors - this is its nature - on the border between closed and open spaces, or along the way between different places. It is here that its journey goes on, with those who walk in this light, stop for a while, come back home. This path means continuous attention over time to each of the different phases. We trace it with the passion of colleagues in the company, through the distribution chain, architects, designers and installers. Each time different and bright of novelty, it is the path that guides us in an enthusiastic dialogue with the moments, with the places and with the people.

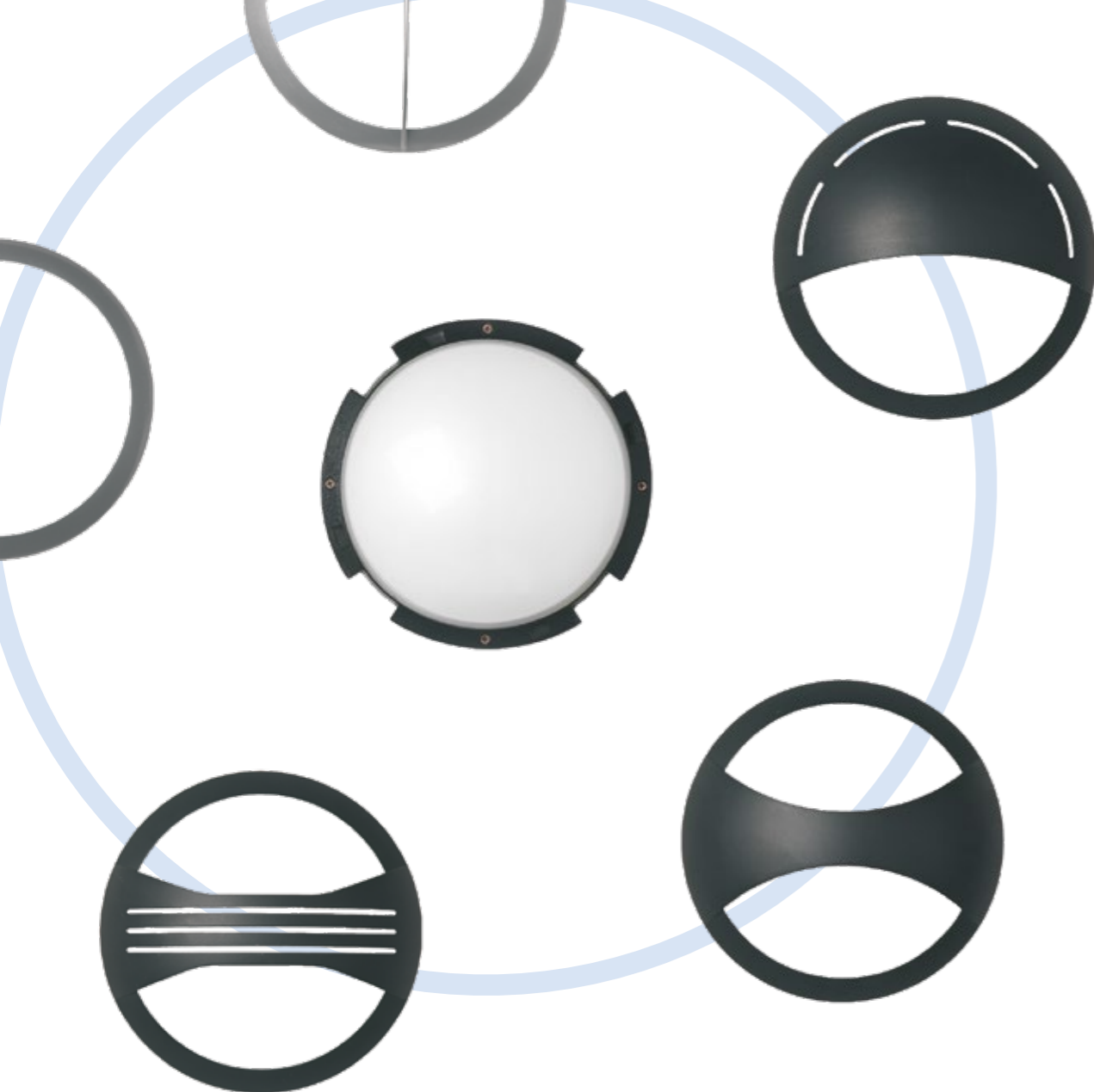

LIGHTS ON MODULARITY

modularità s. f. [der. di modulare]. - Proprietà di ciò che è modulare: m. di una composizione, di una struttura (composta di più elementi); in partic., in urbanistica, in architettura, nell'arredamento, nel disegno industriale, e anche in alcune manifestazioni artistiche non figurative, la ripetizione di una medesima forma o struttura che grazie ad accorgimenti o accessori consente varie possibilità di composizione.

modularity noun [U] - Property of what is modular: m. of a composition, of a structure (composed of several elements); in particular, in urban planning, architecture, furniture, industrial design, and even in some non-figurative artistic manifestations, the repetition of the same shape or structure which, thanks to devices or accessories, allows various possibilities of composition.

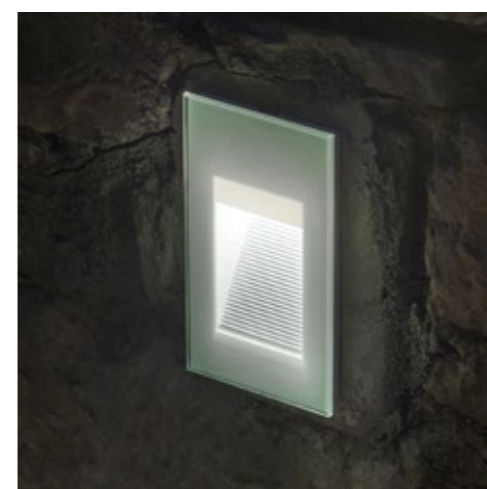
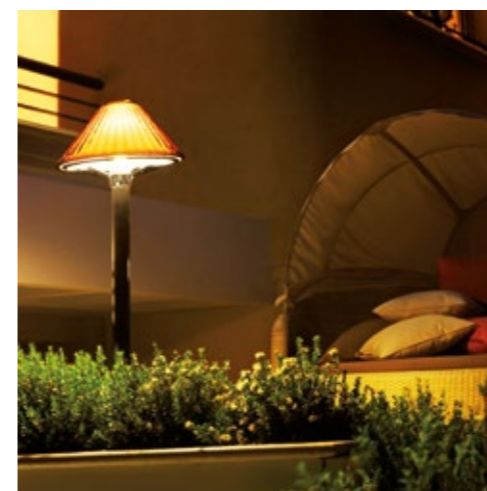

Il concetto di modularità è strettamente legato alle strategie di design e di assemblaggio in chiave produttiva: l'intercambiabilità degli elementi ottimizza il processo a monte della realizzazione del prodotto finito.

L'intuizione è quella di scorporare questo concetto in fase di ingegnerizzazione per permetterne la messa in pratica all'installatore o all'utente finale. Il risultato sono prodotti basilari che si formano con le loro componenti in combinazioni svariate e così rendono possibile una personalizzazione ed un effetto illuminotecnico specifici per l'applicazione desiderata. Da diversi anni il sistema modulare è proposto con grande successo, diventando quasi un marchio di fabbrica di Goccia Illuminazione. Una riconoscibilità ed un riscontro motivati anche dal grande vantaggio di fornire personalizzate e competitive, ma soprattutto dalla libertà compositiva nell'illuminazione.

The concept of modularity is closely connected to the design and assembly strategies in a production key: the interchangeability of the elements optimizes the process upstream of the realization of the finished product.

The intuition is to separate this concept in the engineering phase to allow the installer or the end user to put it into practice. The result is basic products that are formed with their components in various combinations and thus make customization possible and to create a specific lighting effect for the desired application. For several years the modular system has been proposed with great success, almost becoming a trademark of Goccia Illuminazione. A recognition and feedback also motivated by the great advantage of customized and competitive supplies, but above all by freedom in lighting composition.

Nella filiera che va dalla produzione industriale fino alla realizzazione del progetto architettonico pubblico e privato Goccia Illuminazione segue con dedizione ed esperienza clienti ed interessati per lo sviluppo nell'ambito illuminotecnico, con i materiali e i servizi a disposizione.

- Curve fotometriche
- Fotometrie digitali Eulumdat e IES
- Consulenza specifica prodotto
- Consulenza progetto
- Consulenza normative e certificazioni
- Sviluppo calcolo illuminotecnico e render
- Fotoinserimenti e prove RGB
- Richieste illuminotecniche speciali

In the supply chain that goes from industrial production to the realization of the public and private architectural project, Goccia Illuminazione follows with dedication and experience customers and interested parties for the development in the lighting engineering field, with the materials and services available.

- Photometric curves
- Eulumdat and IES digital photometries
- Specific product advice
- Project consulting
- Regulatory advice and certifications
- Lighting calculation and rendering development
- Photo editing and RGB tests
- Special lighting requests

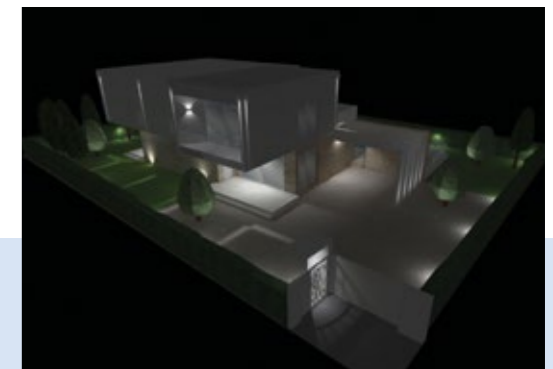

Per assicurare il miglior risultato nel contesto del progetto illuminotecnico, Goccia Illuminazione supporta architetti e lighting designers. In contatto diretto coi progettisti, il nostro ufficio progettazione offre soluzioni e aiuto per la soddisfazione dei clienti. L'ufficio progettazione sviluppa anche calcoli illuminotecnici dedicati, con rendering di riferimento per applicazioni specifiche. Sul nostro sito web sono disponibili i dati fotometrici e le curve illuminotecniche per le applicazioni e le serie desiderate, qui potete richiedere senza impegno la nostra collaborazione per il vostro progetto - goccia.it

To ensure the best result in the context of the lighting project, Goccia Illuminazione supports architects and lighting designers. In direct contact with the designers, our lighting project department offers solutions and help for customer satisfaction. The lighting project department also develops dedicated lighting calculations, with reference rendering for specific applications. Photometric data and lighting curves for the desired applications and series are available on our website, here you can request our collaboration for your project without obligation - goccia.it

L'IDEA CREATIVA DIVENTA REALTÀ

CREATIVE IDEAS BECOME REALITY

INCASSI A TERRA,
A PARETE E
DOWNLIGHT

GROUND OR WALL
RECESSED AND
DOWNLIGHT

PASSUM



PASSUM è la famiglia di apparecchi da incasso per esterni ad alte prestazioni, con massima tecnologia di illuminazione e straordinaria flessibilità e precisione nell'installazione. Contraddistinta da solidità, perfetta tenuta stagna, resistenza alla corrosione, si articola nelle diverse versioni in alluminio o acciaio inox AISI 316L.

PASSUM UP è la scelta per l'illuminazione da incasso verso l'alto, modulare e componibile secondo le esigenze, dispone inoltre di una versione ad altezza d'installazione minimizzata - ultraflat.

PASSUM SIDEWARDS è la serie per l'illuminazione radente laterale da incasso su percorsi e pavimentazioni. Le alte prestazioni delle unità LED sono ottimizzate dalle ottiche con tecnologia per l'emissione laterale - side emitter.

PASSUM SPOT rappresenta l'applicazione più innovativa della famiglia, grazie ai performanti LED e alle ottiche orientabili che ne fanno un inedito proiettore da incasso a pavimento.

PASSUM DOWNLIGHT è la versione downlight da incasso a soffitto. Il sistema di ganci di fissaggio consente di montare le lampade precablate, grazie alla versione ultraflat anche in altezze limitate.

PASSUM is the family of high performance recessed luminaires for outdoor use, with maximum lighting technology and extraordinary flexibility and precision in installation. Characterized by solidity, perfect watertightness, resistance to corrosion, it is divided into different versions in aluminum or AISI 316L stainless steel.

PASSUM UP is the choice for upward recessed lighting, modular and adaptable according to all needs, it also has a version with minimized installation height - ultraflat.

PASSUM SIDEWARDS is the series for recessed side grazing lighting on paths and pavements. The high performance of the LED units is optimized by the optics with side emitter technology.

PASSUM SPOT represents the most innovative application of the family, thanks to the high-performance LEDs and the adjustable optics that make it a brand new recessed floor projector.

PASSUM DOWNLIGHT is the recessed ceiling downlight version. The fixing hook system allows pre-wired lamps to be mounted, thanks to the ultraflat version even in limited heights.

GROUND OR WALL RECESSED



PASSUM UP
Ø 70



PASSUM UP
Ø 125



PASSUM UP
Ø 125 ultraflat



PASSUM UP
Ø 180



PASSUM UP
Ø 245



PASSUM SIDEWARDS
Ø 70



PASSUM SIDEWARDS
Ø 125



PASSUM SIDEWARDS
Ø 180



PASSUM SPOT
Ø 180

CEILING RECESSED



PASSUM DOWNLIGHT
Ø 70



PASSUM DOWNLIGHT
Ø 125



PASSUM DOWNLIGHT
Ø 125 ultraflat



PASSUM DOWNLIGHT
Ø 180



PASSUM DOWNLIGHT
Ø 245

PASSUM UP

Massima componibilità

Le lampade della serie sono fornite in 3 elementi separati:

- **controcassa da interrare** a ridotto spessore in tecnopolimero
- **corpo lampada** in alluminio o INOX AISI 316L, disponibile in 4 diametri: Ø 70, 125, 180 e 245 mm. Con vetro temperato trasparente, spessore da 6 a 12 mm. Versione Ø 125 ultraflat a basso spessore con vetro opale
- **flange di chiusura intercambiabili**, fornite a parte, tonde in alluminio primario, tonde e quadre in INOX AISI 316L con viti inox a brugola

Maximum modularity

The lighting fittings of the range are supplied in 3 separate parts:

- low depth **recessing box** in technopolymer
- **light body** in aluminium or AISI 316L stainless steel, available in Ø 70/125/180 and 245 mm. Security tempered glass, thickness from 6 to 12 mm. Ultraflat Ø 125 version with opal glass
- **covering flanges**, supplied separately, available in copper free aluminium or in AISI 316L stainless steel with stainless steel screws

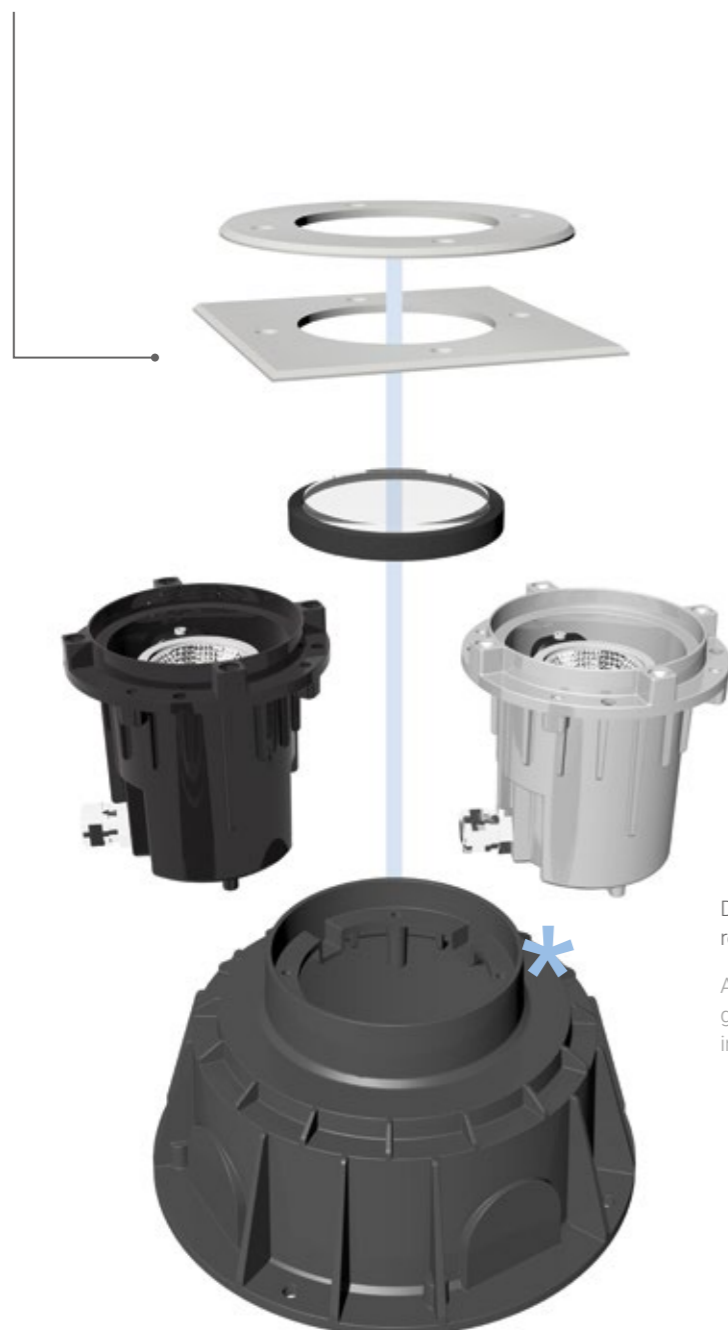

Dopo l'installazione nella cassaforma, è possibile regolare la messa a bolla del corpo lampada.

A complete regulation to align the fitting to the ground is possible even after the recessed box installation.

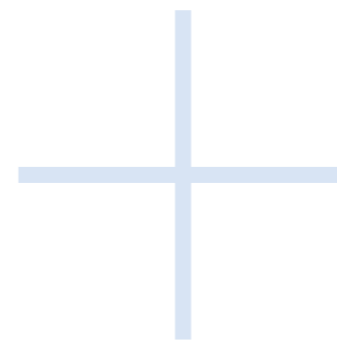

Calpestabili e carrabili

T_s ≤ 40°C. Carico massimo da 2.000 a 3.500 kg (1.000 kg per Ø 70 mm).

Walk over and drive over

Surface T_s ≤ 40°C and max load 2.000-3.500 kg (1.000 kg for Ø 70 mm).

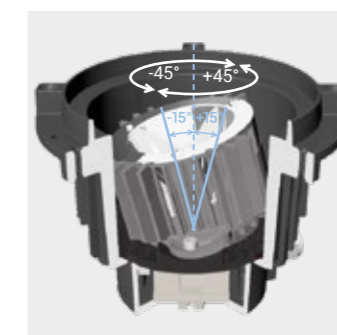

Ottica basculante e rotante

Lottica delle lampade è basculabile per ±15° / 25° (escluso Ø 70) e ruota sul piano orizzontale per un corretto posizionamento del fascio luminoso.

Adjustable and rotating optic

Fully adjustable optic (fixed for Ø 70 mm). Vertically ±15° for Ø 125 / 180 mm and ±15° / ±25° for Ø 245 mm. Horizontally for the right firing.



Cavi in dotazione

Fornito con 0,5 m di cavo interrabile H07RN-F per Ø 125 - 180 - 245 (giunti stagni di connessione opzionali da ordinare separatamente - pag. 51). Cavo in silicone 0,2 m con connettori di isolamento termorestringenti per Ø 70.

Cables supplied

Ø 125 - 180 - 245 fittings are pre-wired with 0,5 m H07RN-F cable (optional waterproof connections to be ordered separately - page 51). Ø 70 fittings are pre-wired with 0,2 m silicone cable and heat-shrinkable insulation connectors.

PASSUM UP

Incasso a terra o parete / Ground or wall recessed



CORPI LAMPADA / LIGHT BODIES Ø 70 mm

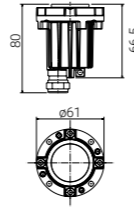

Code	Material	Lamp	W	Lm LED	Real Lm	Optic
1412	aluminium	LED	1	155	88	38°
1413			3	300	162	
1491	AISI 316L stainless steel	LED	1	155	88	38°
1494			3	300	162	

Ottiche opzionali / Optional optics 18° (code + 18), 90° (code + 90)

Driver esterno non compreso / Remote driver to be ordered separately (page 50)

IP 67 con flange / IP 67 with flanges

Su richiesta / On request

2700K (code + 27K)

Lunghezza cavo 7 m / 7 m cable length (code + MT7)

CASSAFORMA / IN-GROUND BOX Ø 70 mm

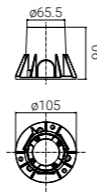

Code	Description
1411	Cassaforma Ø 70 in tecnopolimero da interrare o da parete / In-ground box Ø 70 mm in technopolymer

FLANGE / FLANGES 70 mm



Code	Description
1511	● AN - anthracite ● AG - aluminium grey Flangia tonda Ø 70 in alluminio / Round flange Ø 70 in aluminium
1512	Flangia tonda Ø 70 in acciaio inox AISI 316L / Round flange Ø 70 in AISI 316L stainless steel
1513	● IN - stainless steel Flangia quadrata 70x70 in acciaio inox AISI 316L / Square flange 70x70 in AISI 316L st. steel

Su richiesta / On request

L'insieme corpo lampada+flangia viene fornito montato, sigillato e orientato / The set light body+flange can be supplied assembled, sealed and oriented

● GM - metallized grey

PASSUM UP

Incasso a terra o parete basso spessore / Ground or wall recessed low depth



CORPO LAMPADA / LIGHT BODY Ø 125 mm ULTRAFLAT

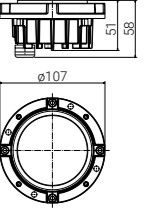

Code	Material	Lamp	W	Lm LED	Real Lm	Optic
1401	aluminium	LED	8	800	347	diffuse
3K - 3000K 4K - 4000K						

Modulo LED a tensione di rete, compatibile con dimmer a taglio di fase / Mains voltage LED module, compatible with most phase-cut dimmers
IP 67 con flange / IP 67 with flanges

Su richiesta / On request

2700K (code + 27K)

12-24V low voltage

CASSAFORMA / IN-GROUND BOX Ø 125 mm ULTRAFLAT

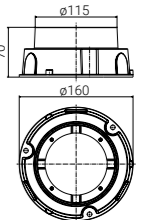

Code	Description
1423	Cassaforma ultraflat Ø 125 mm con profondità di incasso molto contenuta in tecnopolimero / Ultraflat in-ground box Ø 125 mm in technopolymer

FLANGE / FLANGES 125 mm

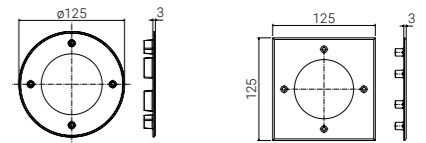

Code	Description
1521	● AN - anthracite ● AG - aluminium grey Flangia tonda Ø 125 in alluminio / Round flange Ø 125 in aluminium
1522	Flangia tonda Ø 125 in acciaio inox AISI 316L / Round flange Ø 125 in AISI 316L stainless steel
1523	● IN - stainless steel Flangia quadrata 125 x 125 in acciaio inox AISI 316L / Square flange 125 x 125 in AISI 316L st. steel

Su richiesta / On request

L'insieme corpo lampada+flangia viene fornito montato, sigillato e orientato / The set light body+flange can be supplied assembled, sealed and oriented

● GM - metallized grey

PASSUM UP

Incasso a terra o parete / Ground or wall recessed



CORPI LAMPADA / LIGHT BODIES Ø 125 mm



aluminium AISI 316L stainless steel

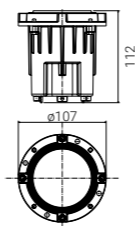

Code	Material	Lamp	W	Lm LED	Real Lm	Optic	
1422	aluminium	3K - 3000K 4K - 4000K	LED	6,5	951	636	38°
1424		-	GU10	5	-	-	-
1495	AISI 316L stainless steel	3K - 3000K 4K - 4000K	LED	4	430	289	38°
1496		-	GU10	5	-	-	-

Ottiche opzionali / Optional optics 18° (code + 18), 90° (code + 90)
 Ottiche basculanti / Adjustable optics 1422, 1495 ±15° / 1424, 1496 ± 8°
 Versione RGBW (vedi capitolo dedicato) / RGBW version (see dedicated chapter)
 GU10 L max 57 mm (forniti senza lampadina / supplied without lamp)
 IP 67 con flange / IP 67 with flanges

Su richiesta / On request
 2700K (code + 27K)
 10+52V low voltage

CASSAFORMA / IN-GROUND BOX Ø 125 mm

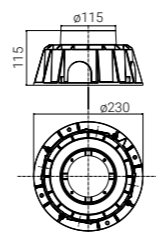

Code	Description
1421	Cassaforma Ø 125 in tecnopolimero da interrare o da parete / In-ground box Ø 125 mm in technopolymer

PASSUM UP

Incasso a terra o parete / Ground or wall recessed



FLANGE / FLANGES 125 mm



code 1521



code 1522 IN



code 1523 IN

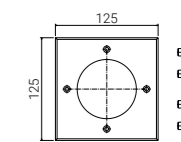
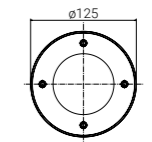

Code	Description
1521	Flangia tonda Ø 125 in alluminio / Round flange Ø 125 in aluminium
1522	Flangia tonda Ø 125 in acciaio inox AISI 316L / Round flange Ø 125 in AISI 316L stainless steel
1523	Flangia quadrata 125 x 125 in acciaio inox AISI 316L / Square flange 125 x 125 in AISI 316L st. steel

Su richiesta / On request
 L'insieme corpo lampada+flangia viene fornito montato, sigillato e orientato /
 The set light body+flange can be supplied assembled, sealed and oriented
 ● GM - metallized grey



PASSUM UP

Incasso a terra o parete / Ground or wall recessed



CORPI LAMPADA / LIGHT BODIES Ø 180 mm



aluminium AISI 316L stainless steel

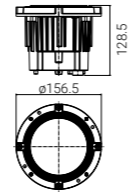

Code	Material	Lamp	W	Lm LED	Real Lm	Optic
1432	aluminium	LED	11	1405	1060	38°
1433			18	2761	1900	
1434	AISI 316L stainless steel	GU10	7-8	-	-	-
1497		LED	6,5	951	636	38°
1498		GU10	7-8	-	-	-

Ottiche opzionali / Optional optics 18° (code + 18), 90° (code + 90)

Ottiche basculanti / Adjustable optics ±15°

Versione RGBW (vedi capitolo dedicato) / RGBW version (see dedicated chapter)

GU10 L max 86 mm (forniti senza lampadina / supplied without lamp)

IP 67 con flange / IP 67 with flanges

Su richiesta / On request

2700K (code + 27K)

CASSAFORMA / IN-GROUND BOX Ø 180 mm

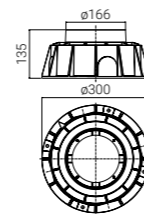

Code	Description
1431	Cassaforma Ø 180 mm in tecnopolimero da interrare o da parete / In-ground box Ø 180 mm in technopolymer

PASSUM UP

Incasso a terra o parete / Ground or wall recessed



FLANGE / FLANGES 180 mm



code 1531



code 1532 IN



code 1533 IN

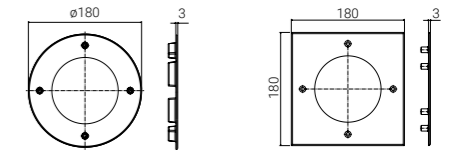

Code	Description
1531	Flangia tonda Ø 180 in alluminio / Round flange Ø 180 in aluminium
1532	Flangia tonda Ø 180 in acciaio inox AISI 316L / Round flange Ø 180 in AISI 316L stainless steel
1533	Flangia quadrata 180 x 180 in acciaio inox AISI 316L / Square flange 180 x 180 in AISI 316L st. steel

Su richiesta / On request

L'insieme corpo lampada+flangia viene fornito montato, sigillato e orientato / The set light body+flange can be supplied assembled, sealed and oriented

● GM - metallized grey





PASSUM UP

Incasso a terra / Ground recessed



CORPI LAMPADA / LIGHT BODIES Ø 245 mm

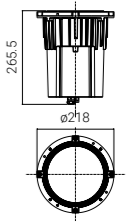

Code	Material	Lamp	W	Lm LED	Real Lm	Optic
1440	aluminium	LED	23	3329	2434	38°
1442			33	4215	3180	
1444		E27	30	-	-	-

Ottiche opzionali / Optional optics
 1440, 1442 18° (code + 18), 1440 70° (code + 70), 1442 90° (code + 90)
 Ottiche basculanti / Adjustable optics 1440 ±15°, 1442, 1444 ±25°
 Versione RGBW (vedi capitolo dedicato) / RGBW version (see dedicated chapter)
 E27 L max 195 mm (fornito senza lampadina / supplied without lamp)
 IP 67 con flange / IP 67 with flanges

Su richiesta / On request
 2700K (code + 27K)
 Versione dimmerabile / Dimmable version

CASSAFORMA / IN-GROUND BOX Ø 245 mm

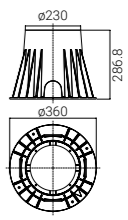

Code	Description
1441	Cassaforma Ø 245 mm in tecnopolimero da interrare / In-ground box Ø 245 mm in technopolymer

FLANGE / FLANGES Ø 245 mm

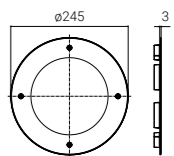
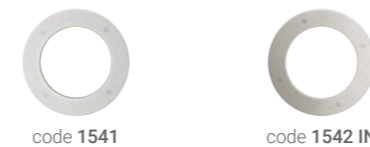

Code	Description
1541	Flangia tonda Ø 245 in alluminio / Round flange Ø 245 in aluminium
1542	Flangia tonda Ø 245 in acciaio inox AISI 316L / Round flange Ø 245 in AISI 316L stainless steel

Su richiesta / On request
 L'insieme corpo lampada+flangia viene fornito montato, sigillato e orientato /
 The set light body+flange can be supplied assembled, sealed and oriented
 ● GM - metallized grey

PASSUM SIDEWARDS



Calotte intercambiabili

Sono fornite a parte con diverse possibilità di orientare la luce radente e finiture.

Changeable canopies

The covering canopies, in different finishing, allow several light emissions.



Dopo l'installazione nella cassaforma, è possibile regolare la messa a bolla del corpo lampada.

A complete regulation to align the fitting to the ground is possible even after the recessed box installation.

Massima componibilità

Le lampade della serie sono fornite in 3 elementi separati:

- **controcassa da interrare** a ridotto spessore in tecnopolimero
- **corpo lampada** in alluminio o INOX AISI 316L, disponibile in 3 diametri: Ø 70, 125 e 180 mm
- **calotte di chiusura**, fornite a parte, con diverse possibilità di illuminazione radente: singola, doppia 2x90°, 180° e 360°

Maximum modularity

The lighting fittings of the range are supplied in 3 separate parts:

- low depth **recessing box** in technopolymer
- **light body** in aluminium or AISI 316L stainless steel, available in Ø 70/125 and 180 mm
- **covering canopies**, supplied separately, available in different emissions: 90°, 2x90°, 180° and 360°

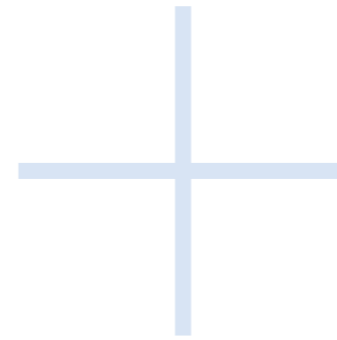

Calpestabili e carrabili

T_s ≤ 40°C. Carico massimo 2.000 kg.

Walk over and drive over

Surface T_s ≤ 40°C and max load 2.000 kg.



Ottica side emitter

LED con ottica side emitter progettata per deviare tutta la luce radente sui lati.

Side emitter optic

The lens directs the light along the ground surface.



Cavi in dotazione

Fornito con 0,5 m di cavo interrabile H07RN-F per Ø 125 - 180 (giunti stagni di connessione opzionali da ordinare separatamente - pag. 51). Cavo in silicone 0,2 m con connettori di isolamento termorestringenti per Ø 70.

Cables supplied

Ø 125 - 180 fittings are pre-wired with 0,5 m H07RN-F cable (optional waterproof connections to be ordered separately - page 51). Ø 70 fittings are pre-wired with 0,2 m silicone cable and heat-shrinkable insulation connectors.

PASSUM SIDEWARDS

Incasso a terra o parete / Ground or wall recessed



CORPI LAMPADA / LIGHT BODIES Ø 70 mm



aluminium



AISI 316L stainless steel

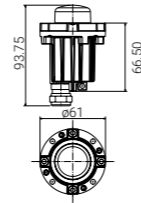

Code	Material	Lamp	W	Lm LED	Real Lm	Optic
1415	aluminium	LED	1	155	1x33	-
1416			3	300	1x65	
1481	AISI 316L stainless steel	LED	1	155	1x33	-
1484			3	300	1x65	

Driver esterno non compreso / Remote driver to be ordered separately (page 50)
 Carico max. / Max load
 2.000 kg codes + 1515, 1516, 1517, 1519 / 500 kg codes + 1591, 1593, 1594
 IP 67 con calotte / IP 67 with canopies

Su richiesta / On request
 2700K (code + **27K**)
 Lunghezza cavo 7 m / 7 m cable length (code + **MT7**)

CASSAFORMA / IN-GROUND BOX Ø 70 mm

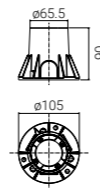

Code	Description
1411	Cassaforma Ø 70 in tecnopolimero da interrare o da parete / In-ground box Ø 70 mm in technopolymer

PASSUM SIDEWARDS

Incasso a terra o parete / Ground or wall recessed



CALOTTE DI CHIUSURA / COVERING CANOPIES Ø 70 mm



code 1515



code 1516



code 1517



code 1519



code 1591 IN



code 1593 IN



code 1594 IN

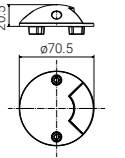

Code	Description
1515	Calotta 1x90° in alluminio / Canopy 1x90° in aluminium
1516	Calotta 180° in alluminio / Canopy 180° in aluminium
1517	Calotta 2x90° in alluminio / Canopy 2x90° in aluminium
1519	Calotta 360° in alluminio / Canopy 360° in aluminium
1591	Calotta 1x90° in acciaio inox AISI 316L / Canopy 1x90° in AISI 316L stainless steel
1593	Calotta 2x90° in acciaio inox AISI 316L / Canopy 2x90° in AISI 316L stainless steel
1594	Calotta 360° in acciaio inox AISI 316L / Canopy 360° in AISI 316L stainless steel

Su richiesta / On request
 L'insieme corpo lampada+calotta viene fornito montato e sigillato /
 The set light body+canopy can be supplied assembled and sealed
 ● **GM** - metallized grey

code 1427 + 1525



PASSUM SIDEWARDS

Incasso a terra o parete / Ground or wall recessed



CORPI LAMPADA / LIGHT BODIES Ø 125 mm

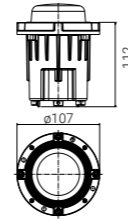

Code	Material	Lamp	W	Lm LED	Real Lm	Optic
1427	aluminium	LED	4	430	1x65	-
1485	AISI 316L stainless steel					

IP 67 con calotte / IP 67 with canopies

Su richiesta / On request

2700K (code + 27K)

10=52V low voltage

CASSAFORMA / IN-GROUND BOX Ø 125 mm

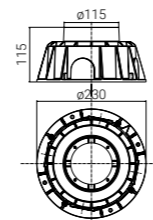

Code	Description
1421	Cassaforma Ø 125 in tecnopolimero da interrare o da parete / In-ground box Ø 125 mm in technopolymer

CALOTTE DI CHIUSURA / COVERING CANOPIES Ø 125 mm

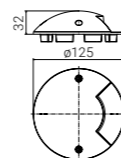

Code	Description
1525	Calotta 1x90° in alluminio / Canopy 1x90° in aluminium
1526	Calotta 180° in alluminio / Canopy 180° in aluminium
1527	Calotta 2x90° in alluminio / Canopy 2x90° in aluminium
1529	Calotta 360° in alluminio / Canopy 360° in aluminium

Su richiesta / On request

L'insieme corpo lampada+calotta viene fornito montato e sigillato / The set light body+canopy can be supplied assembled and sealed

● GM - metallized grey

PASSUM SIDEWARDS

Incasso a terra o parete / Ground or wall recessed



CORPI LAMPADA / LIGHT BODIES Ø 180 mm

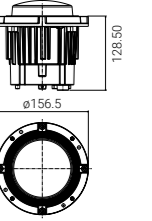

Code	Material	Lamp	W	Lm LED	Real Lm	Optic
1436	aluminium	LED	11	1405	1x68	-
1487	AISI 316L stainless steel					

IP 67 con calotte / IP 67 with canopies

Su richiesta / On request

2700K (code + 27K)

CASSAFORMA / IN-GROUND BOX Ø 180 mm

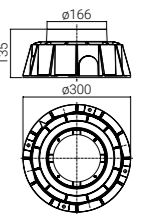

Code	Description
1431	Cassaforma Ø 180 mm in tecnopolimero da interrare o da parete / In-ground box Ø 180 mm in technopolymer

CALOTTE DI CHIUSURA / COVERING CANOPIES Ø 180 mm

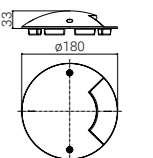
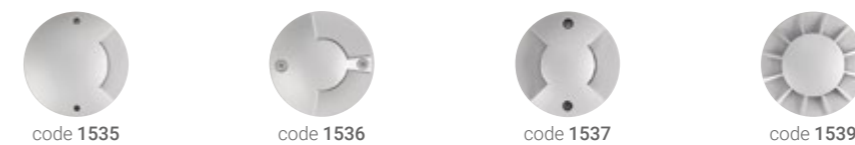

Code	Description
1535	Calotta 1x90° in alluminio / Canopy 1x90° in aluminium
1536	Calotta 180° in alluminio / Canopy 180° in aluminium
1537	Calotta 2x90° in alluminio / Canopy 2x90° in aluminium
1539	Calotta 360° in alluminio / Canopy 360° in aluminium

Su richiesta / On request

L'insieme corpo lampada+calotta viene fornito montato e sigillato / The set light body+canopy can be supplied assembled and sealed

● GM - metallized grey

PASSUM SPOT

Prodotto completo

Le lampade della serie sono fornite assemblate:

- **corpo lampada** in alluminio o acciaio INOX AISI 316L
- **calotta di chiusura** in alluminio primario a doppia verniciatura

Complete product

The lighting fittings of the range are supplied assembled:

- **light body** in aluminum or AISI 316L stainless steel
- **covering canopy** in aluminium with double layer of powder painting



Controcassa

Controcassa da interrare a ridotto spessore in tecnopolimero.

In-ground box

Low depth **recessing box** in technopolymer.

Dopo l'installazione nella cassaforma, è possibile regolare la messa a bolla del corpo lampada.

A complete regulation to align the fitting to the ground is possible even after the recessed box installation.

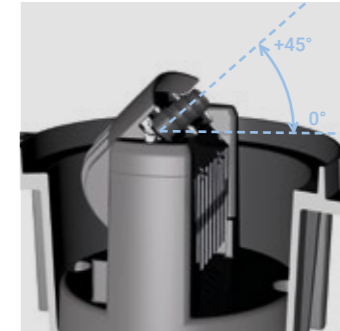
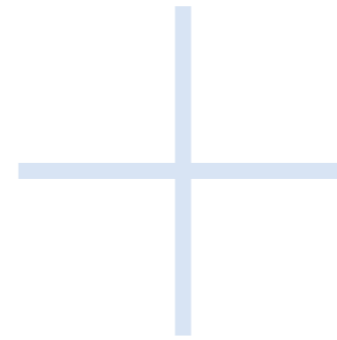

Ottica orientabile

Il gruppo ottico è facilmente regolabile sul piano verticale e consente di orientare la luce da 0° a +45° nella direzione desiderata.

Adjustable optic

The optic unit is easily adjustable and permits to orient the light at the ground surface until 45° upwards.



PASSUM SPOT

Incasso a terra o parete / Ground or wall recessed



LAMPADE CON CALOTTA E LUCE ORIENTABILE / LUMINAIRES WITH CANOPY AND ADJUSTABLE OPTIC Ø 180 mm

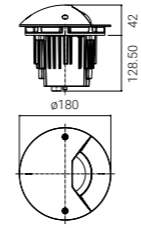

Code			Material	Lamp	W	Lm LED	Real Lm	Optic
1438	● AN - anthracite	3K - 3000K	aluminium body	LED	8	850	605	40°
1488	● AG - aluminium grey	4K - 4000K	AISI 316L st. steel body					

Ottiche opzionali / Optional optics 12° (code + 12)
 Ottiche orientabili / Adjustable optics 0° +45°

CASSAFORMA / IN-GROUND BOX Ø 180 mm

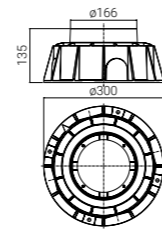

Code	Description
1431	Cassaforma Ø 180 mm in tecnopolimero da interrare o da parete / In-ground box Ø 180 mm in technopolymer



PASSUM DOWNLIGHT

Struttura

Corpo lampada in alluminio primario a basso contenuto di rame, verniciato con polveri poliestere anticorrosione dopo fosfocromatazione. Vetro temperato trasparente o opale a richiesta; spessore da 6 a 12 mm.

Disponibile in 4 diametri: Ø 70, 125, 180 e 245 mm **forniti con flange di chiusura** in alluminio (flange INOX tonde o quadrate a richiesta). Versione Ø 125 ultraflat a basso spessore con vetro opale.

Structure

Lamp body in low copper content primary aluminium with pre-phosphochrome corrosion protection polyester powder coating. Transparent tempered glass, opal upon request, thickness from 6 to 12 mm.

Available in 4 diameters: Ø 70, 125, 180 and 245 mm **supplied with aluminium closing flanges** (round or square stainless steel flanges upon request). Ultraflat Ø 125 version with opal glass.

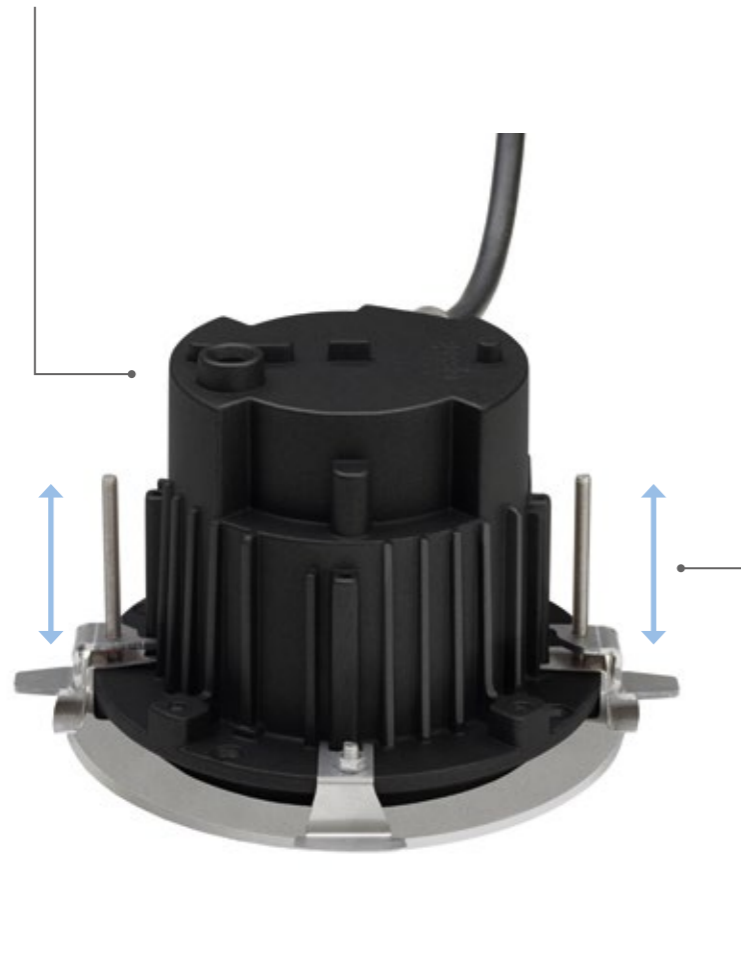

Staffe di fissaggio

Staffe di fissaggio in dotazione per spessori da 5 a 50 mm. Avvitando le viti di bloccaggio in senso orario, le staffe si dispongono nella posizione di aggancio fino a serrare l'apparecchio al controsoffitto.

Fastening brackets

Fastening brackets supplied, for thicknesses from 5 to 50 mm. Tighten the locking screws in the clockwise direction to arrange the hooking position until the fitting is secured to the false ceiling.

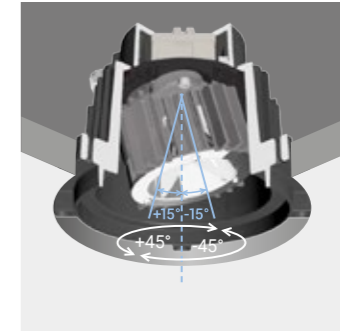
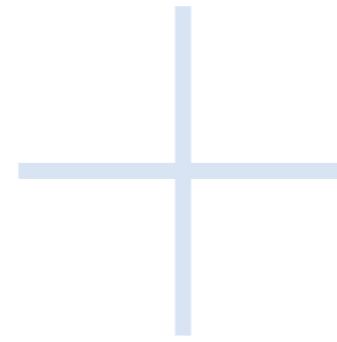

Ottica basculante e rotante

L'ottica delle lampade è basculabile per $\pm 15^\circ / 25^\circ$ (escluso Ø 70) e ruota sul piano orizzontale per un corretto posizionamento del fascio luminoso.

Adjustable and rotating optic

Fully adjustable optic (fixed for Ø 70 mm). Vertically $\pm 15^\circ$ for Ø 125 / 180 mm and $\pm 15^\circ / \pm 25^\circ$ for Ø 245 mm. Horizontally for the right firing.



Cavi in dotazione

Fornito con 0,5 m di cavo H07RN-F per Ø 125 - 180 - 245. Cavo in silicone 0,2 m con connettori di isolamento termorestringenti per Ø 70.

Cables supplied

Ø 125 - 180 - 245 fittings are pre-wired with 0,5 m H07RN-F cable. Ø 70 fittings are pre-wired with 0,2 m silicone cable and heat-shrinkable insulation connectors.

PASSUM DOWNLIGHT

Incasso a soffitto / Ceiling recessed

CRI 80 IP 67 UK CA CE

LAMPADA / LUMINAIRE Ø 70 mm

24V DC IK 08

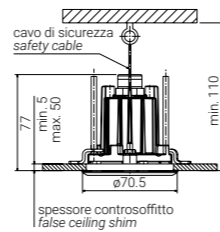

Code		
1470	● AN - anthracite	3K - 3000K
	● AG - aluminium grey	4K - 4000K

Lamp	W	Lm LED	Real Lm	Optic
LED	3	300	162	38°

Ottiche opzionali / Optional optics 18° (code + 18), 90° (code + 90)
 Driver esterno non compreso / Remote driver to be ordered separately (page 50)
 Foro controsoffitto / False ceiling hole Ø min. 65 mm - Ø max. 66 mm

Su richiesta / On request
 2700K (code + 27K)
 ● IN - stainless steel ● GM - metallized grey

PASSUM DOWNLIGHT

Incasso a soffitto / Ceiling recessed

230V 50Hz IP 67 IK 10 UK CA CE

LAMPADA / LUMINAIRE Ø 125 mm ultraflat

CRI ≥ 80

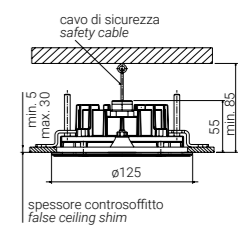

Code		
1479	● AN - anthracite	3K - 3000K
	● AG - aluminium grey	4K - 4000K

Lamp	W	Lm LED	Real Lm	Optic
LED	8	800	347	diffuse

Modulo LED a tensione di rete, compatibile con dimmer a taglio di fase /
 Mains voltage LED module, compatible with most phase-cut dimmers
 Foro controsoffitto / False ceiling hole Ø min. 115 mm - Ø max. 116 mm

Su richiesta / On request
 2700K (code + 27K)
 12-24V low voltage
 ● IN - stainless steel ● GM - metallized grey

LAMPADE / LUMINAIRES Ø 125 mm

230V 50Hz IK 10

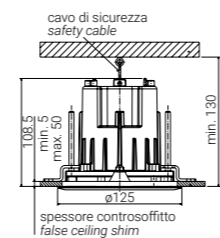

Code		
1472	● AN - anthracite	3K - 3000K
	● AG - aluminium grey	4K - 4000K
1473	● AG - aluminium grey	-

Lamp	W	Lm LED	Real Lm	Optic
LED	6,5	951	636	38°
GU10	5	-	-	-

Ottiche opzionali / Optional optics 18° (code + 18), 90° (code + 90)
 Ottiche basculanti / Adjustable optics 1472 ±15°, 1473 ±8°
 GU10 L max 57 mm (fornita senza lampadina / supplied without lamp)
 Foro controsoffitto / False ceiling hole Ø min. 115 mm - Ø max. 116 mm

Su richiesta / On request
 2700K (code + 27K)
 10-52V low voltage
 Versione RGBW / RGBW version
 ● IN - stainless steel ● GM - metallized grey

LAMPADE / LUMINAIRES Ø 180 mm

CRI 80

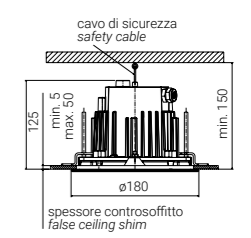

Code		
1474	● AN - anthracite	3K - 3000K
	● AG - aluminium grey	4K - 4000K
1475	● AG - aluminium grey	-

Lamp	W	Lm LED	Real Lm	Optic
LED	11	1405	1060	38°
	18	2761	1900	

Ottiche opzionali / Optional optics 18° (code + 18), 90° (code + 90)
 Ottiche basculanti / Adjustable optics ±15°
 Foro controsoffitto / False ceiling hole Ø min. 164 mm - Ø max. 165 mm

Su richiesta / On request
 2700K (code + 27K)
 Versione RGBW / RGBW version
 ● IN - stainless steel ● GM - metallized grey

PASSUM DOWNLIGHT

Incasso a soffitto / Ceiling recessed



LAMPADE / LUMINAIRES Ø 245 mm

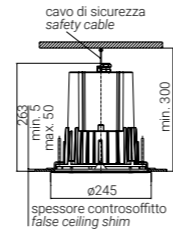

Code

1471	● AN - anthracite	3K - 3000K 4K - 4000K
1476	● AG - aluminium grey	
1478		-

Ottiche opzionali / Optional optics

1471,1476 18° (code + **18**), 1471 70° (code + **70**), 1476 90° (code + **90**)

Ottiche basculanti / Adjustable optics 1471 ±15°, 1476,1478 ±25°

E27 L max 195 mm (fornita senza lampadina / supplied without lamp)

Foro controsoffitto / False ceiling hole Ø min. 225 mm - Ø max. 226 mm

Lamp

Lamp	W	Lm LED	Real Lm	Optic
LED	23	3329	2434	38°
	33	4215	3180	
E27	30	-	-	-

Su richiesta / On request

2700K (code + **27K**)

Versione dimmerabile / Dimmable version

Versione RGBW / RGBW version

● **IN** - stainless steel ● **GM** - metallized grey



ALIMENTATORI 24V DC / 24V DC CONTROL GEARS

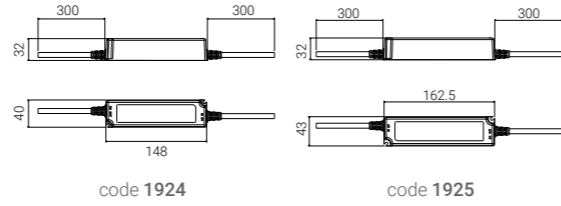

Code	W	Description
1924	25	INPUT 220-240 V - OUTPUT 24V DC
1925	60	

GIUNTI STAGNI / WATERPROOF CONNECTIONS



code 1941



code 1942

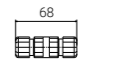

code 1941

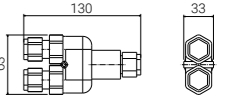

code 1942



code 1944

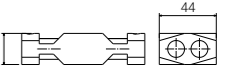

code 1944

Code	Description
1941	Connessione singola 3x2,5 mm ² IP68 / Single connector 3x2,5 mm ² IP 68
1942	Connessione entra-esci 3x2,5 mm ² IP68 / Through wiring connector 3x2,5 mm ² IP 68
1944	Connessione fino a 4 uscite 3x2,5 mm ² IP68 (basato su gel siliconico bicomponente) / Up to 4 outputs connector 3x2,5 mm ² IP 68, based on two-component silicone gel



GRIGLIE ANTIABBAGLIANTI PER PASSUM UP / PASSUM UP ANTIGLARE LOUVERS



code 1971



code 1972

Code	Description	Ref. to
1971	Frangiluce / Antiglare louver PASSUM UP Ø 180	code 1432 code 1433
1972	Frangiluce / Antiglare louver PASSUM UP Ø 245	code 1442

CALPESTABILI DI
SUPERFICIE

GROUND SURFACE
MOUNTED

SQUEEZE



La luce architettonica a pavimento permette un'atmosfera di grande suggestione senza essere invasiva, sia per i grandi progetti illuminotecnici, come per le piccole installazioni. Sulla base di questa consolidata esperienza nasce SQUEEZE, la serie di apparecchi calpestabili senza incasso. Senza bisogno di installare in profondità i componenti, o di lavorare le pavimentazioni, la sua flessibilità di impiego raggiunge nuovi scenari di illuminazione, anche nel contesto esistente. Questo è possibile grazie al contenimento di una tecnologia altamente performante, disponibile in diverse modalità illuminotecniche entro le dimensioni ridotte al minimo. Sprigiona nuove tracce di luce.

Architectural ground lighting creates a highly suggestive ambience with minimum invasiveness, both for major lighting projects and small installations. SQUEEZE, the range of surface mounted ground lights, has been designed based on this consolidated experience. Without the need for recessed installation or flooring works, its flexibility of use achieves new lighting scenarios, even within the existing context. This is possible as it contains a high performance technology available in different and characteristic illuminating options, all minimum in size. To unleash new traces of light.

GROUND SURFACE MOUNTED



SQUEEZE
Ø 77



SQUEEZE
Ø 180



SQUEEZE UP
Ø 59

SQUEEZE

Struttura

Solida struttura in alluminio pressofuso a basso tenore di rame e viti inox. Sorgenti LED dedicate e diffusori in policarbonato anti UV.

Structure

Low copper content die-cast aluminium solid structure and stainless steel screws. Dedicated LED sources and anti UV polycarbonate diffusers.



Fornito con 1,5 m di cavo interrabile in poliuretano 2x0,8 per 24V; 3x1 H07RN-F per 230V.

Comes with 1,5 m polyurethane buriable cable 2x0,8 for 24V; 3x1 H07RN-F for 230V.

ACQUASTOP

Resinatura speciale in corrispondenza dell'ingresso cavi per una tenuta stagna completa. Passacavo in alluminio anticorrosivo anodizzato.

AQUASTOP

Special resin coating at cable entry for complete watertight hold. Anticorrosive anodized aluminium cable gland.

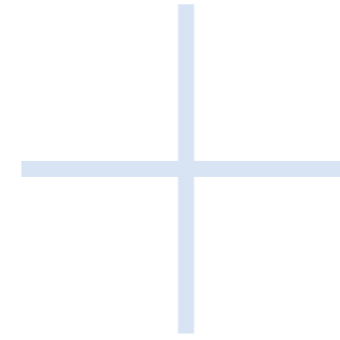

Calpestabili

Resistente struttura in alluminio calpestabile fino a 500 kg.

Walk over

Resistant aluminium ground structure with up to 500 kg weight capacity.



Schermatura antiabbagliante

Sorgente luminosa recessa nella versione a luce laterale per una riduzione efficace dell'abbagliamento diretto.

Anti-glare shielding

Recessed light source in the side light version for the effective reduction of direct dazzle.



Installazione a superficie

Nelle versioni a dimensione ridotta Ø 59 e 77 mm converter 24V resinato nel cilindro passacavo, inseribile nel tubo corrugato. Versione Ø 180 mm totalmente a superficie.

Ground surface installation

In the smaller versions Ø 59 and 77 mm resin coated 24V converter in the cable gland cylinder, which can be inserted in the installation tube. Ø 180 mm version totally flush with the ground.

SQUEEZE

Calpestabile di superficie / Ground surface mounted



SQUEEZE Ø 77 mm 24V

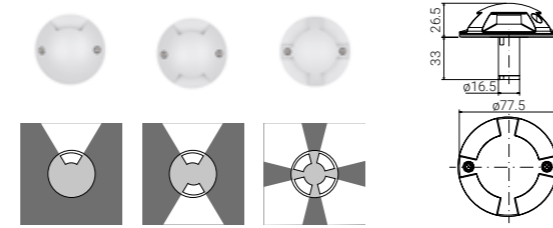

Code

1453	● AN - anthracite	3K - 3000K
1454	● AG - aluminium grey	4K - 4000K
1455		

Driver esterno non compreso / Remote driver to be ordered separately (page 59)
1,5 m di cavo interrabile 2x0,8 / 1,5 m buriable cable 2x0,8

Lamp W Lm LED Real Lm Optic

LED	3	300	65	1x70°
			126	2x70°
			178	4x70°

Su richiesta / On request

Lunghezza cavo 7 m / 7 m cable length (code + **MT7**)

SQUEEZE

Calpestabile di superficie / Ground surface mounted



SQUEEZE Ø 180 mm 230V

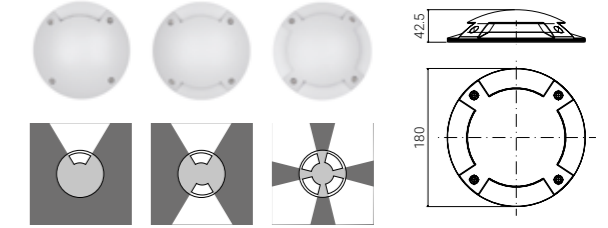

Code

1467	● AN - anthracite	3K - 3000K
1468	● AG - aluminium grey	4K - 4000K
1469		

Modulo LED a tensione di rete, compatibile con dimmer a taglio di fase /
Mains voltage LED module, compatible with most phase-cut dimmers
1,5 m di cavo interrabile 3x1 H07RN-F / 1,5 m buriable cable 3x1 H07RN-F

Lamp W Lm LED Real Lm Optic

LED	4	460	94	1x70°
	8 (2x4)	920	188	2x70°
	8 (4x2)	920	188	4x70°

Su richiesta / On request

Lunghezza cavo 7 m / 7 m cable length (code + **MT7**)

SQUEEZE Ø 180 mm 24V

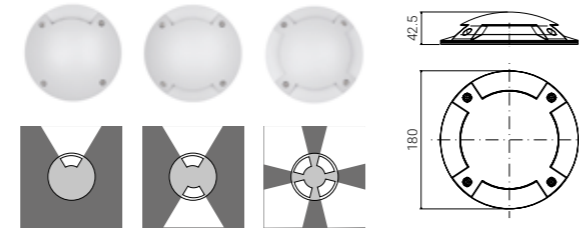

Code

1457	● AN - anthracite	3K - 3000K
1458	● AG - aluminium grey	4K - 4000K
1459		

Driver esterno non compreso / Remote driver to be ordered separately (page 59)
1,5 m di cavo interrabile 2x0,8 / 1,5 m buriable cable 2x0,8

Lamp W Lm LED Real Lm Optic

LED	6,4	640	130	1x70°
	12,8 (2x6,4)	1280	260	2x70°
	12,8 (4x3,2)	1280	215	4x70°

Su richiesta / On request

Lunghezza cavo 7 m / 7 m cable length (code + **MT7**)



SQUEEZE UP

Calpestabile di superficie / Ground surface mounted



SQUEEZE UP Ø 59 mm 24V

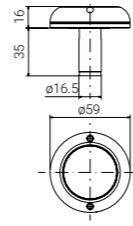

Code	
1451	<ul style="list-style-type: none"> AN - anthracite AG - aluminium grey
	<ul style="list-style-type: none"> 3K - 3000K 4K - 4000K

Lamp	W	Lm LED	Real Lm	Optic
LED	3	300	157	diffuse

Driver esterno non compreso / Remote driver to be ordered separately (page 59)
1,5 m di cavo interrabile 2x0,8 / 1,5 m buriable cable 2x0,8

Su richiesta / On request
Lunghezza cavo 7 m / 7 m cable length (code + **MT7**)



SQUEEZE

Accessori / Accessories



ALIMENTATORI 24V DC / 24V DC CONTROL GEARS

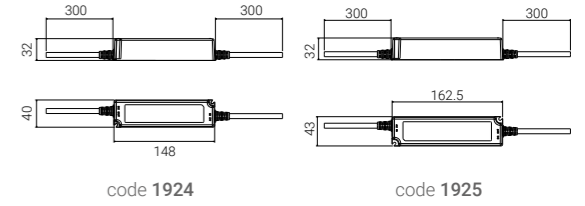

Code	W	Description
1924	25	INPUT 220-240 V - OUTPUT 24V DC
1925	60	

LAMPADE
SEGNAPASSO A
PARETE E SU PALO

STEPLIGHT FITTINGS
AND POSTS

STAMP



La serie STAMP di lampade per esterno amplia il concetto di installazione di superficie e di incasso a parete. La sporgenza minima di 25 o 30 mm offre un'installazione radente senza incasso nella parete.

L'ottica della luce orientata in basso ottimizza la funzione di segnapasso. STAMP è disponibile anche nelle versioni con luce frontale in vetro o laterale sul muro. La lampada dal design essenziale contiene unità LED altamente tecnologiche e di grande resa luminosa. Un distanziale dedicato permette anche l'ingresso / uscita cavi laterale.

La serie si completa con le controcasse accessorio che consentono l'installazione da incasso a filo parete e con i pali STAMP POST di diverse dimensioni, anche in bi-emissione.

The STAMP series of outdoor lamps expands the concept of surface installation and wall recessing. The minimum overhang of 25 or 30 mm offers a grazing installation without recess in the wall.

The optic of the light oriented downwards optimizes the path marker function. STAMP is also available in versions with glass front or side light on the wall. The essential design lamp contains highly technological LED units with great light output. A dedicated spacer also allows for lateral cable entry / exit.

The series is completed with accessory backboxes that allow flush-mounted installation and with STAMP POST poles of different sizes, also in bi-emission.

STEPLIGHT FITTINGS



STEPLIGHT FITTINGS AND WALL EFFECTS



POSTS



STAMP

Struttura

Corpo lampada in alluminio primario anticorrosione a basso contenuto di rame. Diffusore in policarbonato anti UV, recesso per una riduzione efficace dell'abbagliamento diretto.

Structure

Body in low copper content primary aluminium. Diffuser in UV resistant polycarbonate, recessed for an effective reduction of direct glare.

Sporgenza minima Minimum thickness

25-30 mm

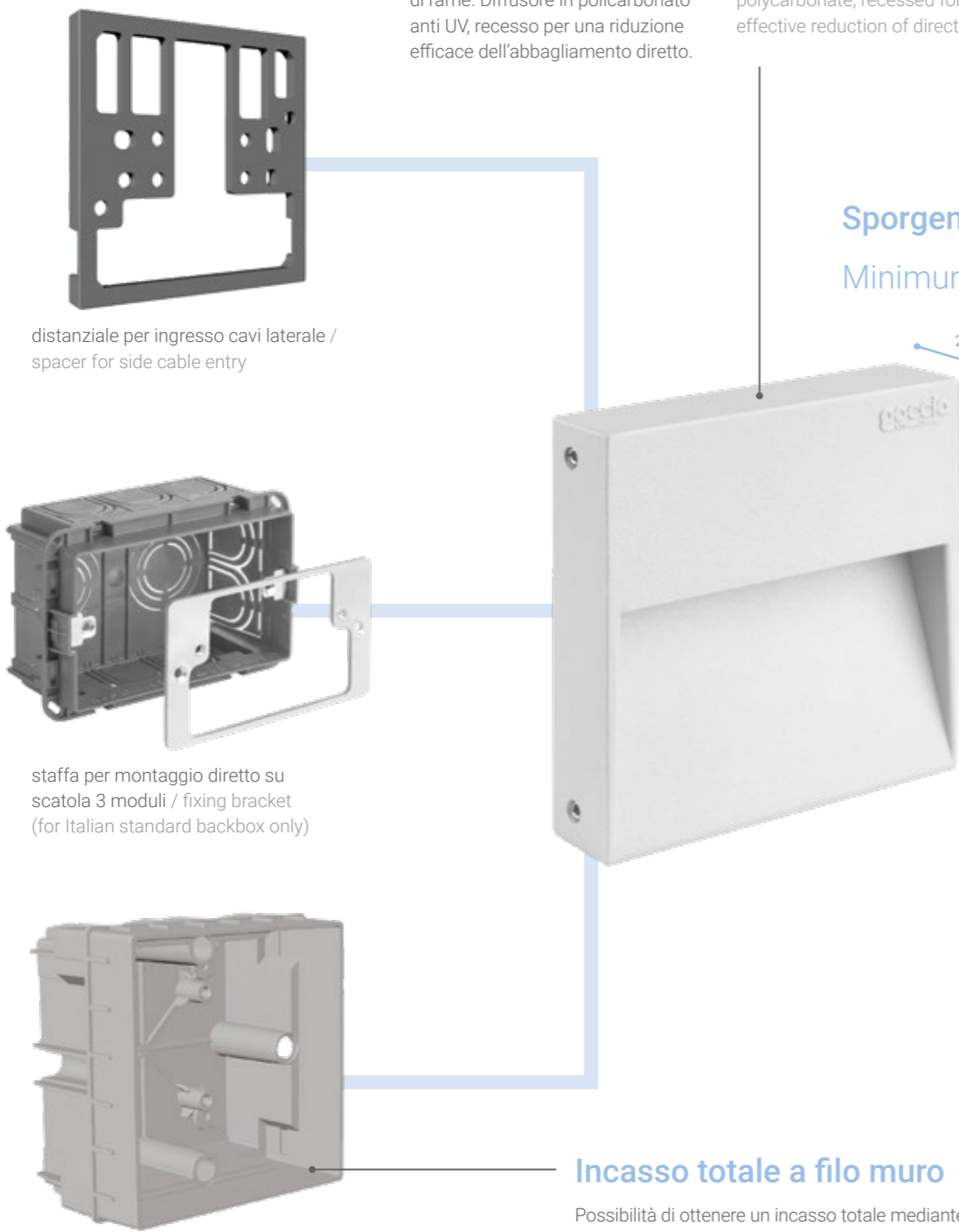

distanziale per ingresso cavi laterale /
spacer for side cable entry

staffa per montaggio diretto su
scatola 3 moduli / fixing bracket
(for Italian standard backbox only)

controcassa per incasso totale /
backbox for flush recessing

Incastro totale a filo muro

Possibilità di ottenere un incastro totale mediante le apposite controcasse fornite con coperchio di protezione.

Wall flush installation

Dedicated backboxes, supplied with protection cover, allow flush recessing.

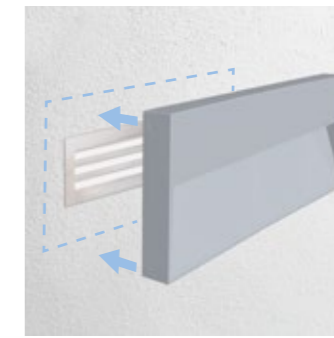
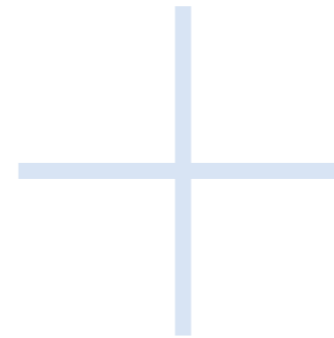

Montaggio a sormonto

La soluzione a superficie risolve la necessità di coprire vani dovuti a precedenti installazioni.

Overlap mounting

The surface solution solves any needs of covering holes due to previous installations.

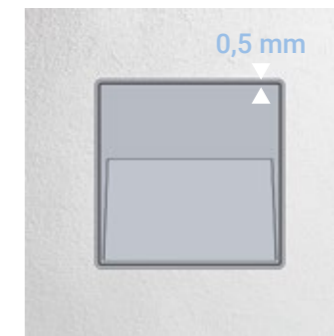

Fessura minima

La fessura tra lampada e controcassa è limitata a soli 0,5 mm.

Minimum slot

The space between the backbox and the recessed light fitting is 0,5 mm only.



Agevole estrazione del corpo lampada

Estrazione semplice del corpo lampada mediante la trazione con le dita sulla palpebra.

Easy luminaire extraction

Remove the light fitting from the backbox by a simple hand pull.

STAMP

Lampada segnapasso / Steplight fitting



STAMP 110

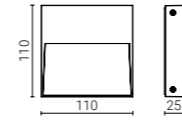

Code

5321	AN - anthracite	3K - 3000K 4K - 4000K
	AG - aluminium grey	
	BI - white	
	CO - corten	

Lamp	W	Lm LED	Real Lm	Optic
LED	4	460	210	asym.

Modulo LED a tensione di rete, compatibile con dimmer a taglio di fase / Mains voltage LED module, compatible with most phase-cut dimmers

Su richiesta / On request

24V low voltage (code + 24V)

GR - graphite GM - metallized grey

STAMP 175-280



code 5323



code 5326

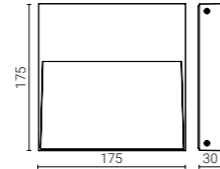

code 5323

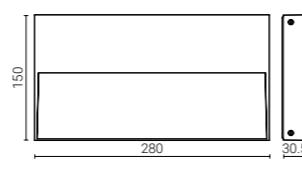

code 5326

Code

5323	AN - anthracite	3K - 3000K 4K - 4000K
	AG - aluminium grey	
5326	BI - white	
	CO - corten	

Lamp	W	Lm LED	Real Lm	Optic
LED	8	1077	520	asym.
	16	2345	936	asym.

Su richiesta / On request

24÷48V low voltage (code + LV)

Versione dimmerabile / Dimmable version

GR - graphite GM - metallized grey



STAMP

Accessori / Accessories



DISTANZIALI / SPACERS



code 5351



code 5352

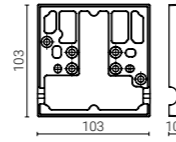

code 5351

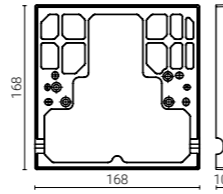

code 5352

Code	Description	Ref. to
5351	Distanziale per ingresso cavi laterale / Spacer for side cable entry	code 5321
5352	Distanziale per ingresso cavi laterale, cablaggio entra/esci consentito / Spacer for side cable entry, through wiring allowed	code 5323

STAMP

Accessori / Accessories



STAFFA PER SCATOLA 3 MOD. / FIXING BRACKET



Code
5360

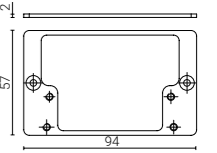

Description	Ref. to
Staffa per fissaggio a sporgere su cassetta 3 moduli standard / Fixing bracket (for Italian standard backbox only)	code 5321

CONTROCASSE / BACKBOXES



code 5358



code 5359

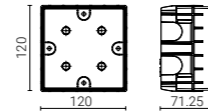

code 5358

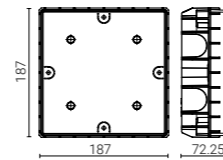

code 5359



code 5357

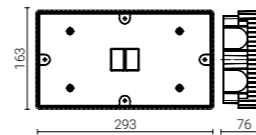

code 5357

Code	Description	Ref. to
5358	Controcassa per incasso totale, completa di coperchio / Backbox for wall flush installation, complete with cover	code 5321
5359		code 5323
5357		code 5326



STAMP POST

Pali / Posts



PALI / POSTS H 300-600

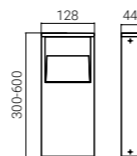

	Code	H	Lamp	W	Lm LED	Real Lm	Optic
5371	● AN - anthracite 3K - 3000K	300 mm	LED	4	460	210	asym.
5372	● AG - aluminium grey 4K - 4000K	600 mm					

Pali in alluminio completi di apparecchio e cavo precablato H05RN-F / Posts in aluminium, fitting and H05RN-F pre-wired cable included

Modulo LED a tensione di rete, compatibile con dimmer a taglio di fase / Mains voltage LED module, compatible with most phase-cut dimmers

Su richiesta / On request

24V low voltage (code + 24V)

● CO - corten

PALI / POSTS H 600-900

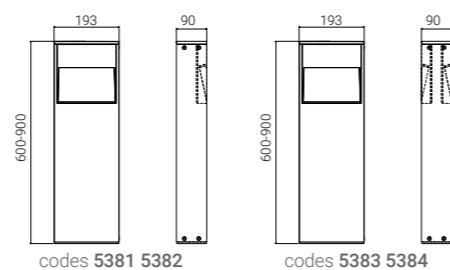

	Code	H	Lamp	W	Lm LED	Real Lm	Optic
5381	● AN - anthracite 3K - 3000K	600 mm	LED	8	1077	520	asym.
5382		900 mm					
5383	● AG - aluminium grey 4K - 4000K	600 mm		16 (2x8)	2154	1040	
5384	900 mm						

Pali in alluminio completi di apparecchio e cavo precablato H05RN-F / Posts in aluminium, fitting and H05RN-F pre-wired cable included

Su richiesta / On request

24=48V low voltage (code + LV)

Versione dimmerabile / Dimmable version

● CO - corten





STAMP POST

Accessori / Accessories



PIASTRE TIRAFONDI / PLATES WITH ANCHORING SET



code 5391



code 5392

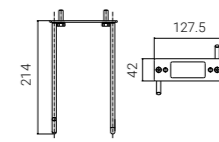

code 5391

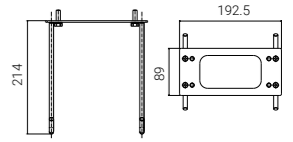

code 5392

Code	Description	Ref. to
5391	Piastra inox con tirafondi per ancoraggio al terreno / Stainless steel plate with ground anchoring set	code 5371 code 5372
5392		code 5381 code 5382 code 5383 code 5384

GIUNTI STAGNI / WATERPROOF CONNECTIONS



code 1941



code 1944

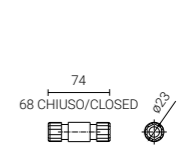

code 1941

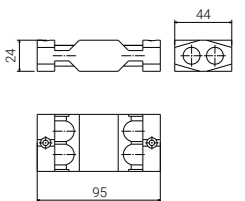

code 1944

Code	Description
1941	Connessione singola 3x2,5 mm ² IP68 / Single connector 3x2,5 mm ² IP 68
1944	Connessione fino a 4 uscite 3x2,5 mm ² IP68 (basato su gel silicónico bicomponente) / Up to 4 outputs connector 3x2,5 mm ² , based on two-component silicone gel

STAMP VETRO / GLASS

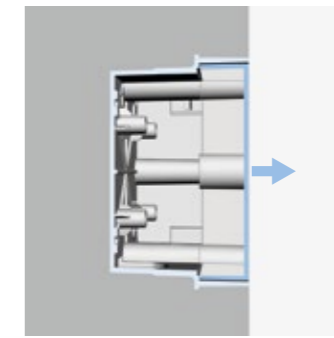
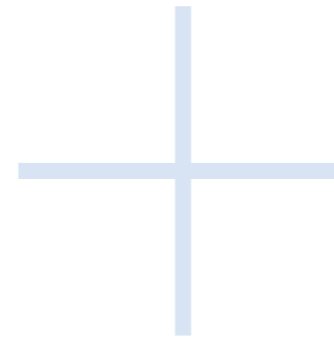

Incasso totale a filo muro

Le controcasse sono fornite con un robusto coperchio di protezione e permettono di ottenere una reale ed effettiva sporgenza zero.

Wall flush installation

The backboxes are supplied with a robust protection cover and allow to obtain a real and effective zero protrusion.



Estrazione con ventosa

Agevole estrazione del corpo lampada con ventosa in dotazione.

Removable by the sucker

Easy luminaire extraction by the sucker supplied.



Versione su palo

Disponibile in due altezze; fornita con spezzone di cavo in bassa tensione.

Post version

Available in two heights; supplied with low voltage cable.

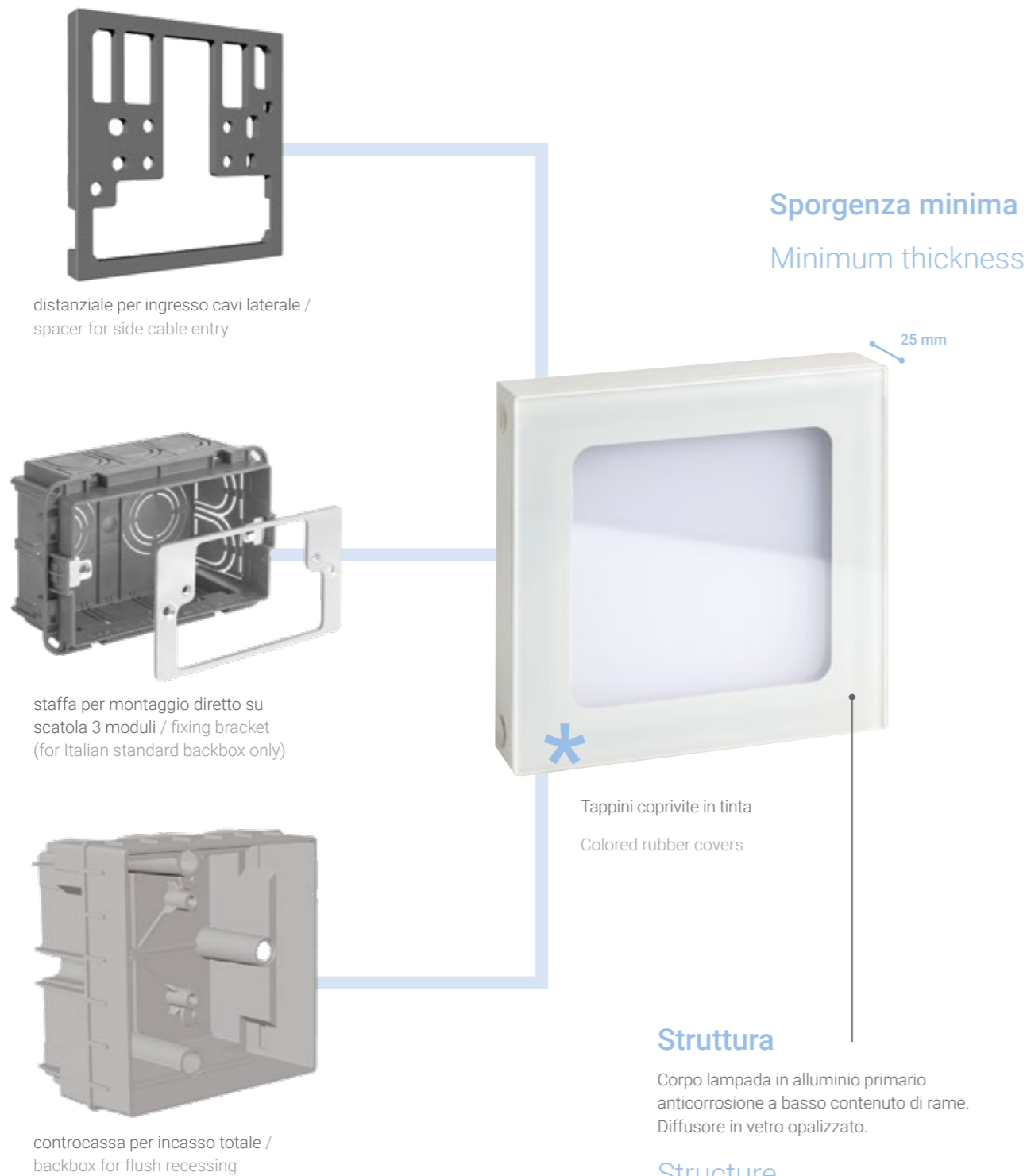

Structure

Body in low copper content primary aluminium.
Diffuser in opal glass.

STAMP VETRO / GLASS

Lampada segnapasso / Steplight fitting



LAMPADA / LUMINAIRE

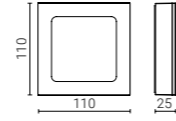

Code	Lamp	W	Lm LED	Real Lm	Optic
5331	LED	6	698	302	diffuse

Code	Color	Temp
● AN	anthracite	
● AG	aluminium grey	3K - 3000K 4K - 4000K
○ BI	white	

Driver esterno non compreso / Remote driver to be ordered separately (page 76)

STAMP POST VETRO / POST GLASS

Pali / Posts



PALI / POSTS H 300-600

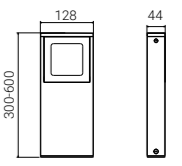

Code	H	Lamp	W	Lm LED	Real Lm	Optic
5374	300 mm	LED	6	698	302	diffuse
5375	600 mm					

Code	Color	Temp
● AN	anthracite	
● AG	aluminium grey	3K - 3000K 4K - 4000K
○ BI	white	

Pali in alluminio completi di apparecchio e cavo precablato / Posts in aluminium, fitting and pre-wired cable included
 Driver esterno non compreso / Remote driver to be ordered separately (page 76)



PIASTRA TIRAFONDI / PLATE WITH ANCHORING SET

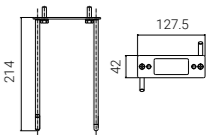

Code	Description
5391	Piastra inox con tirafondi per ancoraggio al terreno / Stainless steel plate with ground anchoring set

STAMP VETRO / GLASS

Accessori / Accessories



ALIMENTATORI 24V DC / 24V DC CONTROL GEARS

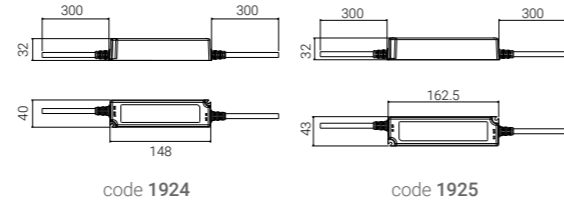

Code	W	Description
1924	25	INPUT 220-240 V - OUTPUT 24V DC
1925	60	

DISTANZIALE / SPACER

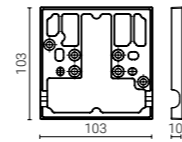

Code	Description
5351	Distanziale per ingresso cavi laterale / Spacer for side cable entry

STAMP VETRO / GLASS

Accessori / Accessories



CONTROCASSA / BACKBOX

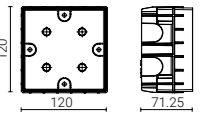

Code	Description
5358	Controcassa per incasso totale, completa di coperchio / Backbox for wall flush installation, complete with cover

STAFFA PER SCATOLA 3 MOD. / FIXING BRACKET

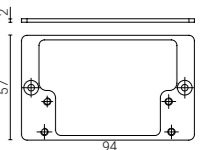

Code	Description
5360	Staffa per fissaggio a sporgere su cassetta 3 moduli standard / Fixing bracket (for Italian standard backbox only)

STAMP LUCE LATERALE / SIDE LIGHT

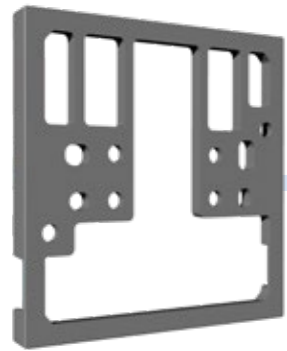
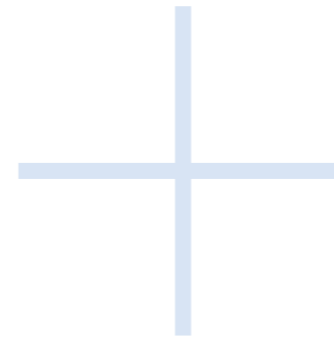

distanziale per ingresso cavi laterale /
spacer for side cable entry

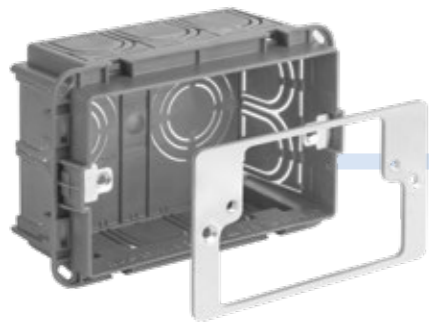

staffa per montaggio diretto su
scatola 3 moduli / fixing bracket
(for Italian standard backbox only)



1, 2 o 4 finestre
1, 2 or 4 windows

Struttura

Corpo lampada in alluminio primario anticorrosione a basso contenuto di rame.
Diffusori in policarbonato anti UV.

Structure

Body in low copper content primary aluminium.
Diffusers in UV resistant polycarbonate.



Sporgenza minima

L'accurato design e la scelta della componentistica permettono uno spessore contenuto di soli 25,5 mm per tutti le versioni.

Minimum thickness

The accurate design and the choice of components enable to obtain a 25,5 mm minimum protrusion for all versions.



Tappini coprivite in tinta

Colored rubber covers

STAMP LUCE LATERALE / SIDE LIGHT

Segnapasso e effetti a parete / Steplight fitting and wall effects



LAMPADE / LUMINAIRES



code 5335 1 light code 5336 2 lights code 5337 4 lights

Code	
5335	● AN - anthracite
5336	● AG - aluminium grey
5337	○ BI - white

3K - 3000K
4K - 4000K

Lamp	W	Lm LED	Real Lm	Optic
LED	4	460	250	diffuse
	8 (2x4)	920	500	
	8 (4x2)	920	500	

Modulo LED a tensione di rete, compatibile con dimmer a taglio di fase / Mains voltage LED module, compatible with most phase-cut dimmers

Su richiesta / On request
24V low voltage (code + 24V)

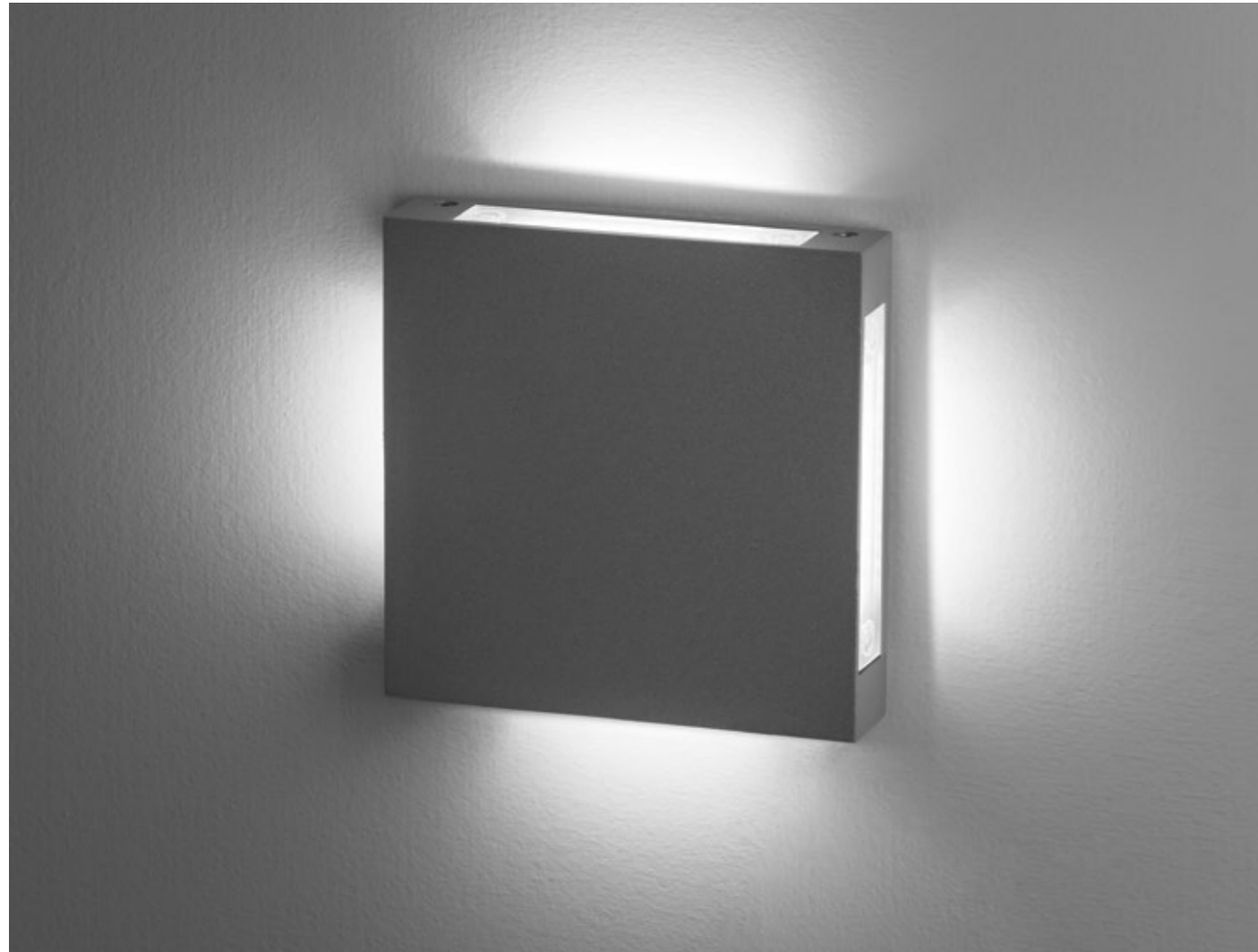

STAMP LUCE LATERALE / SIDE LIGHT

Accessori / Accessories



DISTANZIALE / SPACER

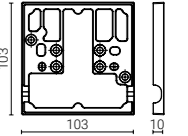

Code	Description
5351	Distanziale per ingresso cavi laterale / Spacer for side cable entry

STAFFA PER SCATOLA 3 MOD. / FIXING BRACKET

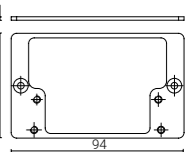

Code	Description
5360	Staffa per fissaggio a sporgere su cassetta 3 moduli standard / Fixing bracket (for Italian standard backbox only)

QUANTUM



La serie di apparecchi da incasso a tenuta stagna QUANTUM è stata progettata fin dall'origine appositamente per l'applicazione LED. La concezione innovativa del sistema ha consentito di inserire in un corpo di dimensioni ridotte il generoso dissipatore, con trasformatore che consente di collegare QUANTUM alla normale linea 230V. Il sistema modulare di QUANTUM permette di rivestire il corpo lampada con maschere di diverso disegno e materiali. L'aggancio a scatto assicurato da due viti esagonali facilita l'installazione. Le lampade si installano sia nelle comuni scatole per interni da 3, 4 o 6 moduli che nelle speciali controcasse dedicate Goccia Illuminazione per l'uso esterno. La serie si completa con i pali e le piantane QUANTUM POST per illuminare percorsi pedonali, scale, piste ciclabili, parchi e giardini.

The QUANTUM series of waterproof recessed luminaires was designed from the outset specifically for LED application. The innovative concept of the system has made it possible to insert the generous heat sink in a small body, with a transformer that allows QUANTUM to be connected to the normal 230V line. The QUANTUM modular system allows the lamp body to be covered with masks of different designs and materials. The snap coupling secured by two hex screws facilitates installation. The lamps are installed for outdoor use in the Goccia Illuminazione dedicated backboxes. The series is completed with QUANTUM POST to illuminate pedestrian paths, stairs, cycle paths, parks and gardens.

WALL RECESSED



QUANTUM
4 mod.



QUANTUM
3 mod.



QUANTUM
4 mod.



QUANTUM
6 mod.



QUANTUM
6 mod.

POSTS



QUANTUM POST
H 495













QUANTUM POST
H 110



QUANTUM POST
H 580-825

QUANTUM

Products	Light bodies	Backboxes	Covering masks
3 mod.			   
4 mod.			     
4 mod.			     
6 mod.			     
6 mod.			              

QUANTUM



QUANTUM

Massima componibilità

La Serie QUANTUM, totalmente componibile, è composta da:

- **controcasse** 503 / 504 / 506 di mercato o specifiche Goccia Illuminazione
- **corpi in policarbonato** a 3 / 4 / 6 moduli standard
- **maschere intercambiabili** in alluminio, policarbonato, INOX AISI 316L o vetro opale

Maximum modularity

The lighting fittings of the range are supplied in 3 separate parts:

- recessing Goccia Illuminazione **backboxes**, horizontal and vertical
- **polycarbonate lamp bodies** in different wattages and dimensions
- **covering masks** in polycarbonate, aluminium, AISI 316L stainless steel or glass

Incastro snapping della maschera sul corpo con ritenzione di sicurezza mediante viti a brugola inox in tinta.

Mask snap connection on body with safety retention with stainless steel matching Allen key screws.



Dimensioni ridotte

Goccia Illuminazione ha inserito in un **corpo di dimensioni ridotte** un LED ad alta efficienza e un trasformatore con un potente dissipatore.

Small dimensions

Goccia Illuminazione has inserted a high efficiency LED and a transformer with a powerful diffuser inside a **compact body**.

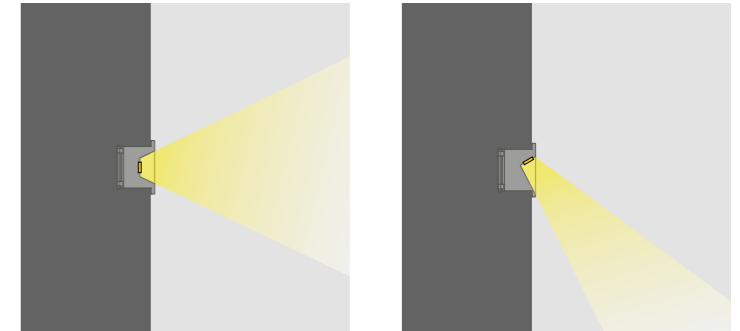
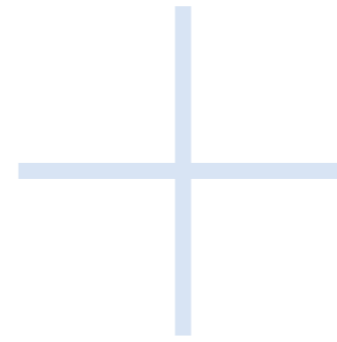

La giusta luce

Le particolari forme degli apparecchi permettono di **distribuire la luce verso il basso o frontalmente** offrendo un'ampia gamma illuminotecnica.

The right light

The particular shapes of the fittings allow you to **distribute light downwards or frontally**, offering a wide lighting range.

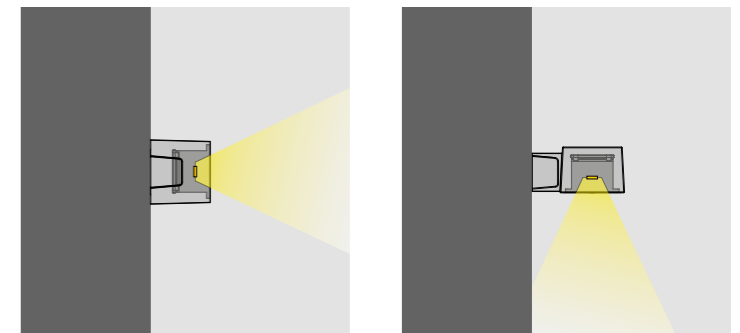

Installazione a sporgere

I **contenitori a sporgere, frontali o wall-washer**, consentono l'installazione di QUANTUM anche su pareti finite o non incassabili. Il **canale portacavi** in alluminio permette di alimentare più apparecchi senza incasso.

Protruding installation

Front or wall washer protruding containers allow for QUANTUM installation also on surface or where you cannot recess. The aluminium cable trunking allows you to power more than one luminaire without recessing.

QUANTUM

Incasso a parete a tenuta stagna / Watertight wall recessed



CORPO LAMPADA / LIGHT BODY 4 mod.

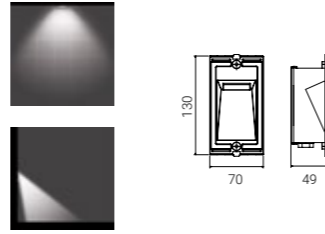

Code	
5425	3K - 3000K 4K - 4000K

Lamp	W	Lm LED	Real Lm	Optic
LED	4,5	265	168	asym.

Installabile su scatola 4 mod. o cod. 5481 /
To be installed on the backbox code 5481 (page 94)

Su richiesta / On request
12-24V low voltage (code + LV)

QUANTUM

Incasso a parete a tenuta stagna / Watertight wall recessed



CORPO LAMPADA / LIGHT BODY 3 mod.

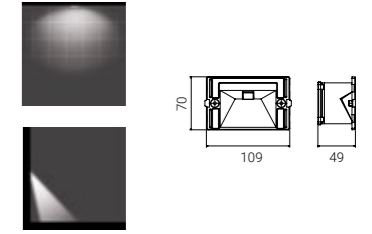

Code	
5420	3K - 3000K 4K - 4000K

Lamp	W	Lm LED	Real Lm	Optic
LED	2	212	115	asym.

Installabile su scatola 3 mod. o cod. 5480 /
To be installed on the backbox code 5480 (page 94)

Su richiesta / On request
2700K (code + 27K)
10=52V low voltage (code + LV)

MASCHERE / MASKS 4 mod.



code 5452 GR



code 5462

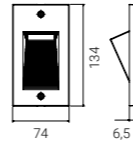

code 5452 5462



code 5472 IN



code 5441 OP

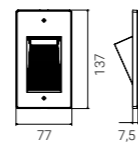

code 5472

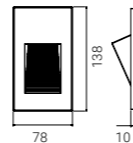

code 5441

Code	Description
5452	● GR - graphite
5462	● GR - graphite
	● GM - metallized grey
	○ BI - white
5472	● IN - stainless steel
5441	● OP - opal white

Description
Maschera di rivestimento in policarbonato / Covering mask in polycarbonate
Maschera di rivestimento in alluminio pressofuso / Covering mask in die-cast aluminium
Maschera di rivestimento in acciaio inox AISI 316L / Covering mask in AISI 316L st. steel
Maschera di rivestimento in vetro piano temprato / Covering mask in flat tempered glass

MASCHERE / MASKS 3 mod.



code 5460



code 5442 OP

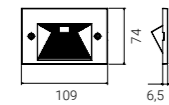

code 5460

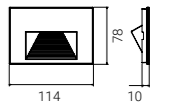

code 5442

Code	Description
5460	● GR - graphite
	● GM - metallized grey
	○ BI - white
5442	● OP - opal white

Description
Maschera di rivestimento in alluminio pressofuso / Covering mask in die-cast aluminium
Maschera di rivestimento in vetro piano temprato / Covering mask in flat tempered glass

QUANTUM

Incasso a parete a tenuta stagna / Watertight wall recessed



CORPO LAMPADA / LIGHT BODY 4 mod.

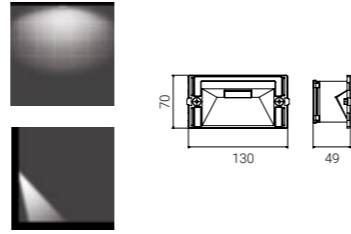

Code	
5430	3K - 3000K 4K - 4000K

Installabile su scatola 4 mod. o cod. 5481 /
To be installed on the backbox code 5481 (page 94)

Lamp	W	Lm LED	Real Lm	Optic
LED	4,5	265	168	asym.

Su richiesta / On request
10=52V low voltage (code + LV)

QUANTUM

Incasso a parete a tenuta stagna / Watertight wall recessed



CORPO LAMPADA / LIGHT BODY 6 mod.

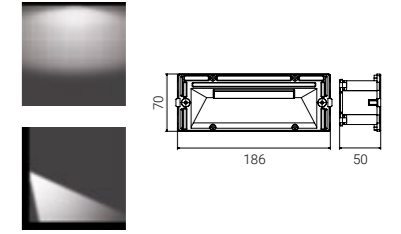

Code	
5435	3K - 3000K 4K - 4000K

Installabile su scatola 6 mod. o cod. 5482 /
To be installed on the backbox code 5482 (page 94)

Lamp	W	Lm LED	Real Lm	Optic
LED	4,5	460	273	asym.

Su richiesta / On request
10=52V low voltage (code + LV)

MASCHERE / MASKS 4 mod.



code 5453 GR



code 5463

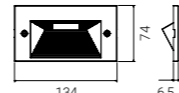

code 5453 5463



code 5473 IN



code 5443 OP

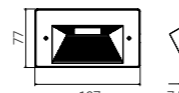

code 5473



code 5443

Code	Description
5453	Maschera di rivestimento in policarbonato / Covering mask in polycarbonate
5463	Maschera di rivestimento in alluminio pressofuso / Covering mask in die-cast aluminium
5473	Maschera di rivestimento in acciaio inox AISI 316L / Covering mask in AISI 316L st. steel
5443	Maschera di rivestimento in vetro piano temprato / Covering mask in flat tempered glass

MASCHERE / MASKS 6 mod.



code 5454 GR



code 5464

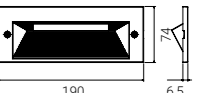

code 5454 5464



code 5474 IN



code 5444 OP



code 5474

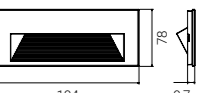

code 5444

Code	Description
5454	Maschera di rivestimento in policarbonato / Covering mask in polycarbonate
5464	Maschera di rivestimento in alluminio pressofuso / Covering mask in die-cast aluminium
5474	Maschera di rivestimento in acciaio inox AISI 316L / Covering mask in AISI 316L st. steel
5444	Maschera di rivestimento in vetro piano temprato / Covering mask in flat tempered glass

QUANTUM

Incasso a parete a tenuta stagna / Watertight wall recessed



CORPO LAMPADA / LIGHT BODY 6 mod.

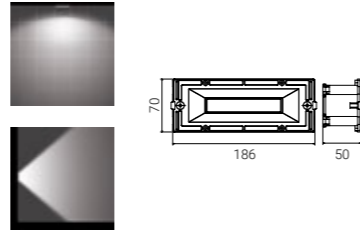

Code	
5440	3K - 3000K 4K - 4000K

Installabile su scatola 6 mod. o cod. 5482 /
To be installed on the backbox code 5482 (page 94)

Lamp	W	Lm LED	Real Lm	Optic
LED	4,5	460	325	diffuse

Su richiesta / On request
10+52V low voltage (code + LV)

code 5435+5444OP



QUANTUM

Incasso a parete a tenuta stagna / Watertight wall recessed



MASCHERE / MASKS 6 mod.



code 5455 GR



code 5465



code 5466



code 5467



code 5475 IN



code 5476 IN



code 5477 IN

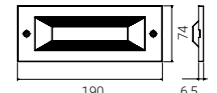

code 5455

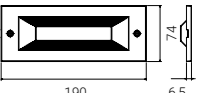

code 5465

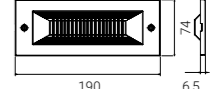

code 5466

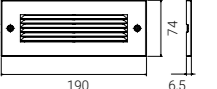

code 5467

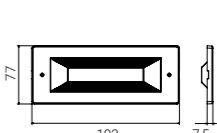

code 5475

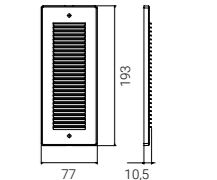

code 5476

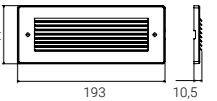

code 5477

Code	Description
5455	● GR - graphite
5465	● GR - graphite
5466	● GM - metallized grey
5467	○ BI - white
5475	
5476	● IN - stainless steel
5477	

Description
Maschera di rivestimento in policarbonato / Covering mask in polycarbonate
Maschera di rivestimento in alluminio pressofuso / Covering mask in die-cast aluminium
Maschera di rivestimento in acciaio inox AISI 316L / Covering mask in AISI 316L st. steel

CONTROCASSE / BACKBOXES

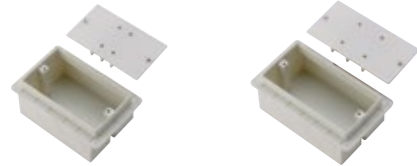

code 5480

code 5481

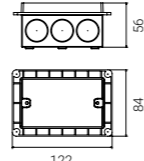

code 5480

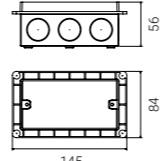

code 5481



code 5482

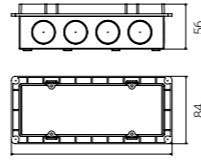

code 5482

Code	Description	Ref. to
5480	Controcassa 3 mod., completa di coperchio / Backbox 3 mod., cover included	code 5420
5481	Controcassa 4 mod., completa di coperchio / Backbox 4 mod., cover included	code 5425 code 5430
5482	Controcassa 6 mod., completa di coperchio / Backbox 6 mod., cover included	code 5435 code 5440

CONTENITORI / BOXES



code 5411



code 5412

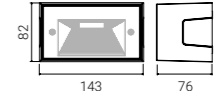
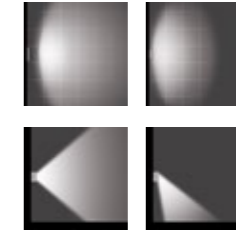

code 5411

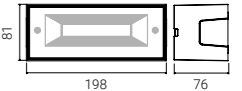

code 5412



code 5415



code 5416

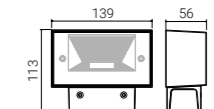
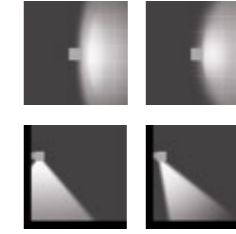

code 5415

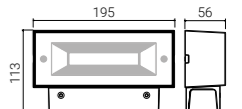

code 5416

Code	Description	Ref. to
5411	Contenitore sporgente in alluminio / Aluminium external box	code 5430
5412		code 5435 code 5440
5415	Contenitore wall washer in alluminio / Aluminium wall washer box	code 5430
5416		code 5435 code 5440

Predisposto per contenere corpo lampada e relativa maschera /
Made to contain light body and its mask

5411, 5412 Ingresso cavi Ø 14 laterale o dal retro /
Rear or side cable entry, suitable to 14 mm Ø wiring

5415, 5416 Ingresso cavi Ø 12 laterale o dal retro /
Rear or side cable entry, suitable to 12 mm Ø wiring

Idoneo per cablaggio passante / Through wiring allowed

Morsettiera entra / esci incorporata / Terminal block incorporated

QUANTUM

Sistema portacavi per installazione sporgente a parete / Cable trunking system for protruding wall installation

IK 10  

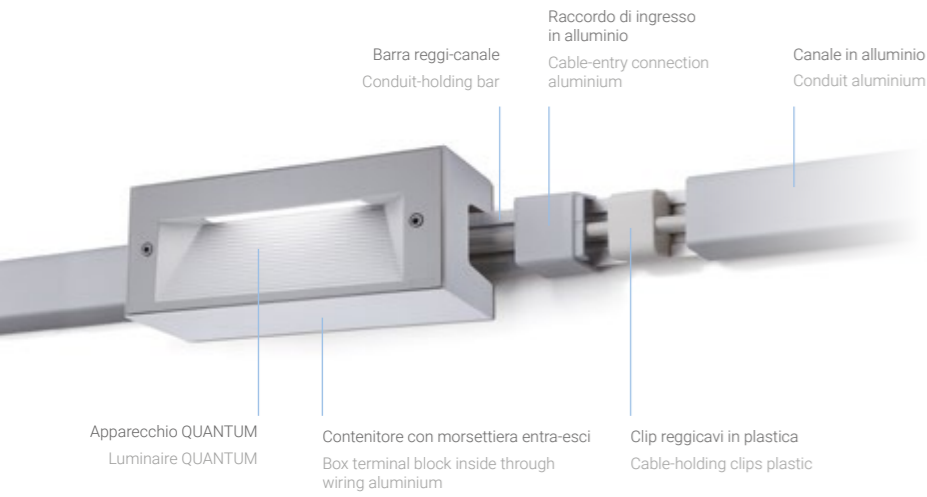

Il Sistema Portacavi con canale antivandalo IK10, completamente in alluminio estruso, consente di alimentare numerosi corpi lampada con il contenitore sporgente o wall washer con un unico punto luce. È possibile così installare punti luce anche su superfici difficilmente incassabili o già esistenti.

The vandal-proof IK10 cable trunking, completely in extruded aluminium, allows to give power to many lights starting from only one light point. Suitable to hold the external or the wall-washer boxes. In this way you can bring the light where you cannot recess a backbox or where the wall already is existing.

SISTEMA PORTACAVI / CABLE TRUNKING SYSTEM

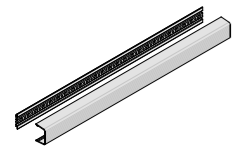

code 5401

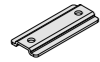

code 5402

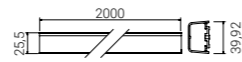

code 5401

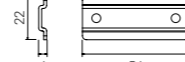

code 5402

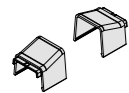

code 5405 5406

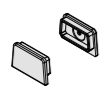

code 5407

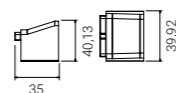

code 5405

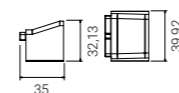

code 5406



code 5407

Code	
5401	<ul style="list-style-type: none"> GR - graphite GM - metallized grey
5402	-
5405	<ul style="list-style-type: none"> GR - graphite
5406	<ul style="list-style-type: none"> GM - metallized grey
5407	-

Description	Ref. to
Canale portacavi in alluminio estruso verniciato / Cable trunking in extruded aluminium	-
Staffa di giunzione in acciaio / Steel connection bracket	-
Coppia di raccordi in alluminio / Pair of connections in aluminium	code 5411 code 5412 code 5415 code 5416
Tappo di chiusura canale in gomma grigia / Rubber side cap	-

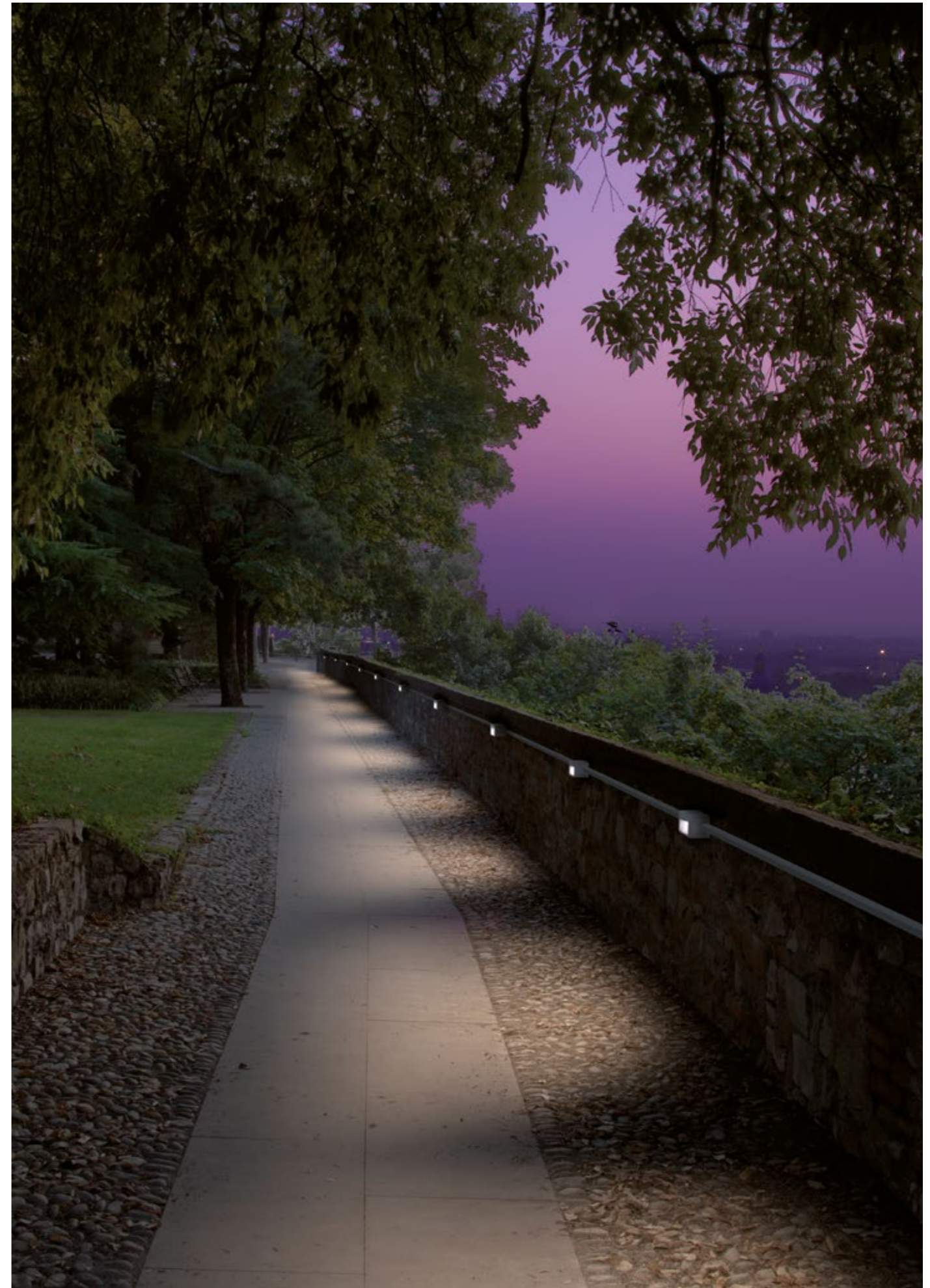

QUANTUM POST

Pali da giardino / Garden posts



PALO / POST H 495



Code	
5591	<ul style="list-style-type: none"> GR - graphite GM - metallized grey

Lamp	W	Lm LED	Real Lm	Optic
LED	4,5	265	168	asym.

Palo in alluminio completo di apparecchio frontale + maschera / Post in aluminium + fixture + mask
 È possibile inserire corpo 5440 sul retro con maschere 5465, 5466 / The body 5440 + masks 5465, 5466 can be installed on the back (optional)
 Cassetta di derivazione incorporata / Connection box inside

Su richiesta / On request
 12-24V low voltage (code + LV)

QUANTUM POST

Pali da giardino / Garden posts



PALI / POSTS H 110



code 5596 code 5598

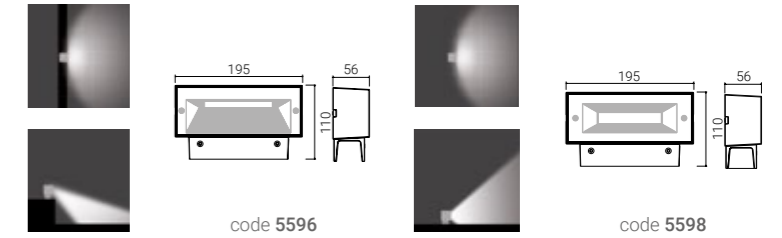

Code	
5596	<ul style="list-style-type: none"> GR - graphite GM - metallized grey

Lamp	W	Lm LED	Real Lm	Optic
LED	4,5	460	273	asym.
			325	diffuse

Palo in alluminio completo di apparecchio + maschera / Post in aluminium + fixture + mask

Su richiesta / On request
 10÷52V low voltage (code + LV)

PIASTRA TIRAFONDI / PLATE WITH ANCHORING SET

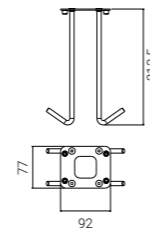

Code	Description
5496	Piastra inox con tirafondi per ancoraggio al terreno / Stainless steel plate with ground anchoring set

PIASTRA TIRAFONDI / PLATE WITH ANCHORING SET

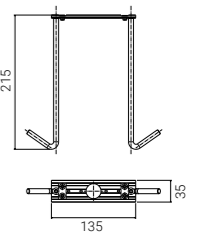

Code	Description
5495	Piastra inox con tirafondi per ancoraggio al terreno / Stainless steel plate with ground anchoring set

QUANTUM POST

Pali da giardino / Garden posts



PALI / POSTS H 580-825

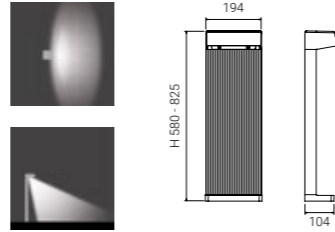

Code			H	Lamp	W	Lm LED	Real Lm	Optic
5594	GR - graphite	3K - 3000K	580 mm	LED	13	1500	1123	diffuse
5593	GM - metallized grey	4K - 4000K	825 mm					

Palo in alluminio + piastra inox reggi-tirafondi incorporata (tirafondi forniti separatamente) / Post in aluminium + stainless steel plate incorporated (anchoring set supplied separately)

Su richiesta / On request
2700K (code + **27K**)
Versione dimmerabile / Dimmable version

PALI CON SENSORE / POSTS WITH SENSOR H 580-825

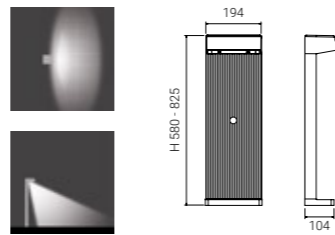

Code			H	Lamp	W	Lm LED	Real Lm	Optic
5599	GR - graphite	3K - 3000K	580 mm	LED	13	1500	1123	diffuse
5597	GM - metallized grey	4K - 4000K	825 mm					

Palo in alluminio + piastra inox reggi-tirafondi incorporata (tirafondi forniti separatamente) / Post in aluminium + stainless steel plate incorporated (anchoring set supplied separately)

Completo di rilevatore di presenza a raggi infrarossi e tre regolazioni / With infrared sensor and three regulations

Scatola di cablaggio incorporata / Wiring box incorporated

Su richiesta / On request
2700K (code + **27K**)
Funzione Corridor / Corridor function

QUANTUM POST

Accessori / Accessories



TIRAFONDI / ANCHORING SET

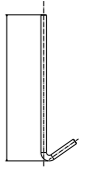

Code	Description
5529	4 tirafondi inox per ancoraggio al terreno / 4 stainless steel ground anchors



CLOCK



Un piccolo proiettore circolare dal design essenziale e di carattere, CLOCK è uno spotlight versatile e preciso. Spessore contenuto ed elegante orientabilità, con le sue due dimensioni offre grande qualità illuminotecnica, grazie ai performanti LED ed alle ottiche accuratamente studiate per permettere svariate modalità di impiego del flusso luminoso.

Gli accessori a corredo incrementano le tipologie di installazione ed il comfort visivo di CLOCK con stile - soluzioni puntuali per un'illuminazione d'accento scenografico e vibrante.

A small circular projector with an essential design and character, CLOCK is a versatile and precise spotlight. Low thickness and elegant adjustability, with its two dimensions it offers great lighting quality, thanks to the high-performance LEDs and specific designed optics to allow various ways of using the luminous flux.

The accessories supplied increase the types of installation and the visual comfort of CLOCK with style - punctual solutions for scenographic and vibrant accent lighting.

SPOTLIGHT

CLOCK
Ø 80CLOCK
Ø 120

CLOCK

Spessore ridotto

Lo spessore di soli 36 mm per i due diametri consente un inserimento non invasivo negli ambienti esterni.

Reduced thickness

Its 36 mm thickness for both diameters allows to fix CLOCK discreetly in outdoor settings.

Il corpo in alluminio ruota intorno al perno di fissaggio per facilitare l'orientamento sul piano verticale. Il blocco è garantito da una vite 8MA. Due asole sulla base consentono l'orientamento orizzontale $\pm 40^\circ$.

The aluminium body rotates around the locking pin on the vertical surface to easily adjust its direction. An 8MA screw locks it in place. Two eyelets on the base allow for a $\pm 40^\circ$ horizontal adjustment.



Cablaggio stagno

CLOCK è ermeticamente chiuso con resina bicomponente e fornito con 1,5 m di cavo interrabile H05RN-F. Il cavo può passare nell'apposito foro della basetta del braccio.

- Pressacavo in ottone
- Resinatura Acquastop
- Cavo antistrappo

Watertight wiring

CLOCK is hermetically sealed with a two-component resin and provided with an 1,5 m H05RN-F cable. The cable can pass through a special hole in the base of the arm.

- Brass cable gland
- Aquastop Resin Finish
- Anti-tear cable

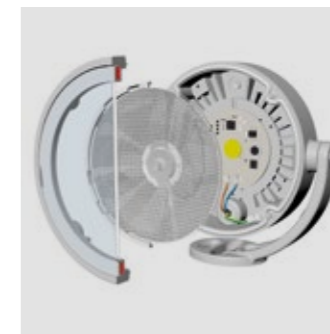
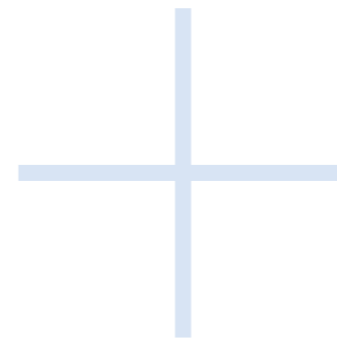

Vetro sigillato

Il vetro frontale temprato trasparente ultrawhite è sigillato alla cornice di chiusura per consentire la massima tenuta.

Sealed glass

The front tempered ultrawhite clear glass is sealed to the frame for a perfect watertight.

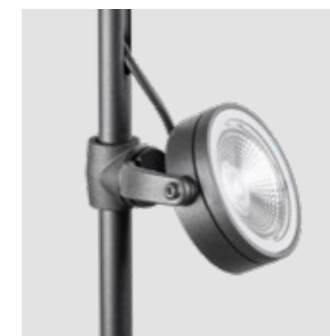

Steli da giardino

Steli da giardino predisposti per passaggio cavi grazie ad apposite asole.

Garden stems

Garden stems suitable for cable entry thanks to dedicated slots.



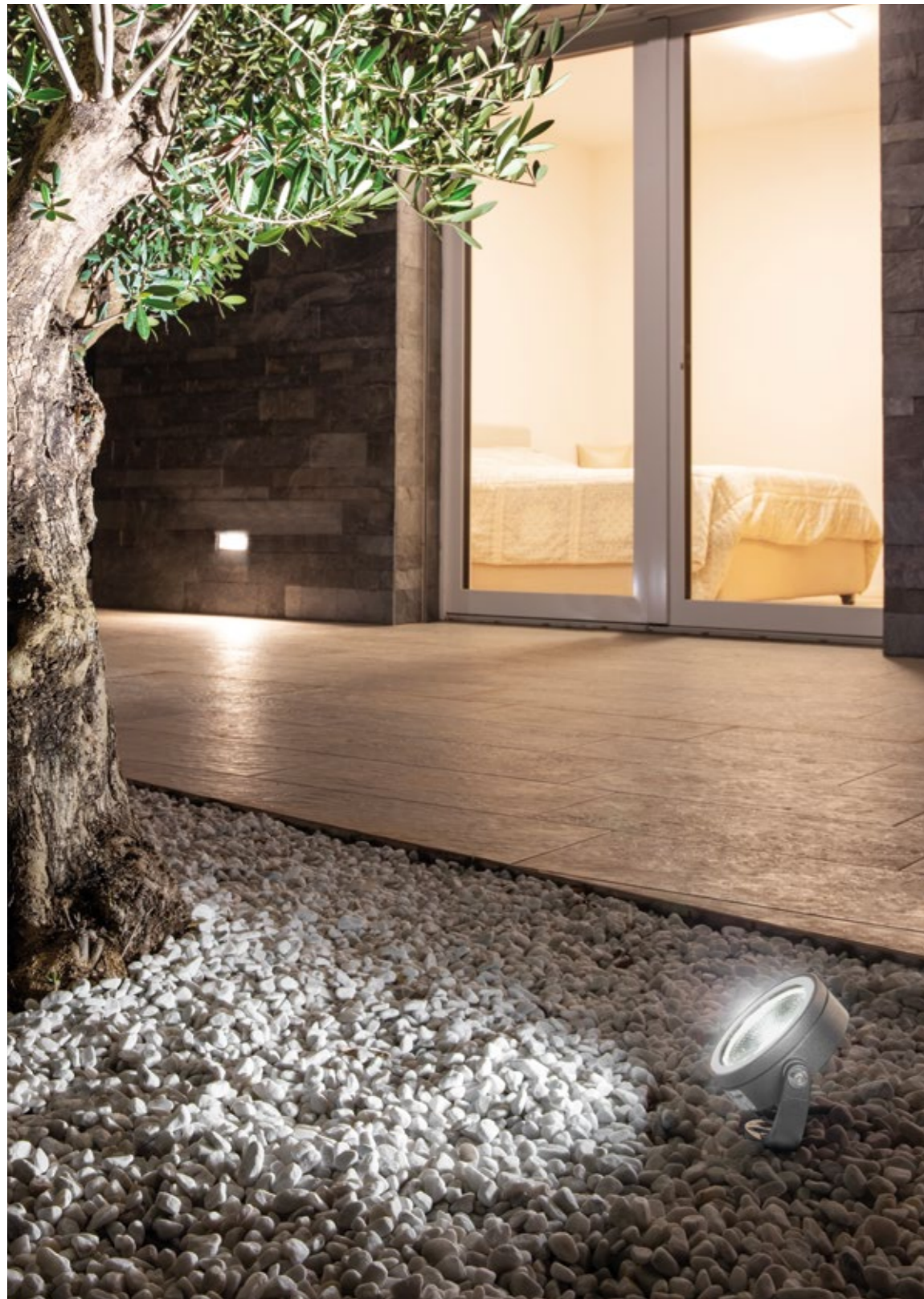

CLOCK

Spot / Spotlight



CLOCK Ø 80 mm

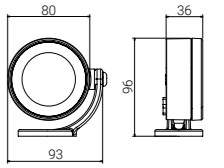

	Code	
4661	AN - anthracite	3K - 3000K 4K - 4000K
	AG - aluminium grey	
	VE - green	

Lamp	W	Lm LED	Real Lm	Optic
LED	4	460	290	40°

Ottiche opzionali / Optional optics 12° (code + 12), 90° (code + 90)
 Fornita con 1,5 m di cavo interrabile / 1,5 m buriabile cable included
 Modulo LED a tensione di rete, compatibile con dimmer a taglio di fase /
 Mains voltage LED module, compatible with most phase-cut dimmers
 Versione RGBW (vedi capitolo dedicato) / RGBW version (see dedicated chapter)

Su richiesta / On request
 2700K (code + 27K)
 12-24V low voltage, cable L 20 cm (code + LV)
 Lunghezza cavo 7 m / 7 m cable length (code + MT7)
 BI - white CO - corten GR - graphite GM - metallized grey

CLOCK Ø 120 mm

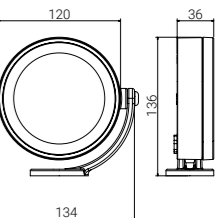

	Code	
4664	AN - anthracite	3K - 3000K 4K - 4000K
	AG - aluminium grey	
4665	VE - green	

Lamp	W	Lm LED	Real Lm	Optic
LED	10	1100	750	40°
	15	1575	1050	

Ottiche opzionali / Optional optics 12° (code + 12), 90° (code + 90)
 Fornite con 1,5 m di cavo interrabile / 1,5 m buriabile cable included
 Modulo LED a tensione di rete, compatibile con dimmer a taglio di fase /
 Mains voltage LED module, compatible with most phase-cut dimmers
 Versione RGBW (vedi capitolo dedicato) / RGBW version (see dedicated chapter)

Su richiesta / On request
 2700K (code + 27K)
 12-24V low voltage, cable L 20 cm
 Lunghezza cavo 7 m / 7 m cable length (code + MT7)
 Ottica a nido d'ape / Honeycomb optic 10° (code + HC)
 BI - white CO - corten GR - graphite GM - metallized grey

CLOCK

Accessori / Accessories

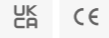

VISIERA / SHIELD

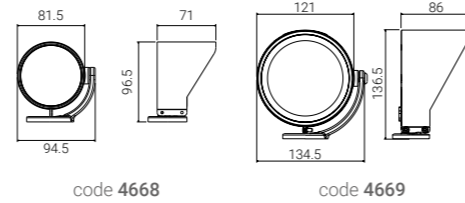

code 4668

code 4669

Code	Description	Ref. to
4668	Visiera in acciaio inox verniciato / Shield in painted stainless steel	code 4661
4669		code 4664
		code 4665

CLOCK

Accessori / Accessories



PICCHETTO / SPIKE



Code	Description	Ref. to
4691	Picchetto da giardino in policarbonato / Garden spike in polycarbonate	code 4661
		code 4664
		code 4665

Altezza da terra consigliata: 10 cm come da normativa / Recommended height above ground: 10 cm in compliance with regulations

Il cavo può passare nell'apposito foro della basetta e nella struttura del picchetto / The cable can pass through a special hole in the base and through the structure of the spike

GIUNTI STAGNI / WATERPROOF CONNECTIONS

IP 68



code 1941



code 1942



code 1941



code 1942

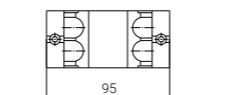
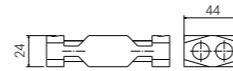
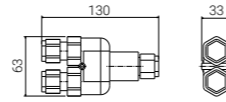

code 1944



code 1944

Code	Description
1941	Connessione singola 3x2,5 mm ² IP68 / Single connector 3x2,5 mm ² IP 68
1942	Connessione entra-esce 3x2,5 mm ² IP68 / Through wiring connector 3x2,5 mm ² IP 68
1944	Connessione fino a 4 uscite 3x2,5 mm ² IP68 (basato su gel siliconico bicomponente) / Up to 4 outputs connector 3x2,5 mm ² IP 68, based on two-component silicone gel

BRACCIO A MURO / WALL ARM

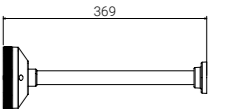

Code	Description	Ref. to
4692	Braccio in alluminio / Aluminium arm	code 4661
		code 4664
		code 4665

Cablaggio interno alla basetta; cablaggio esterno per versioni RGBW / Internal terminal block; external wiring for RGBW versions

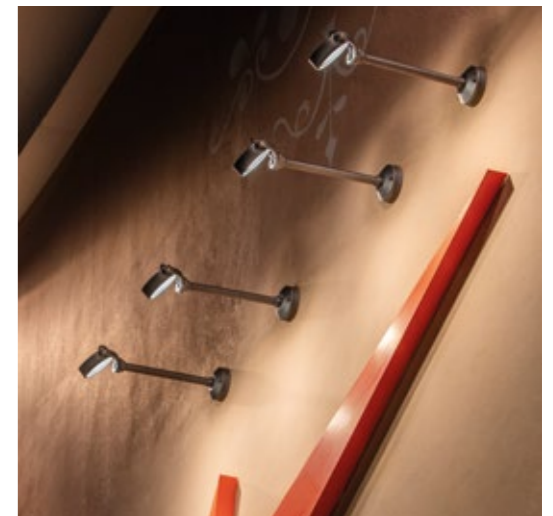



CLOCK

Accessori / Accessories



CLOCK

Accessori / Accessories



STELI / STEMS

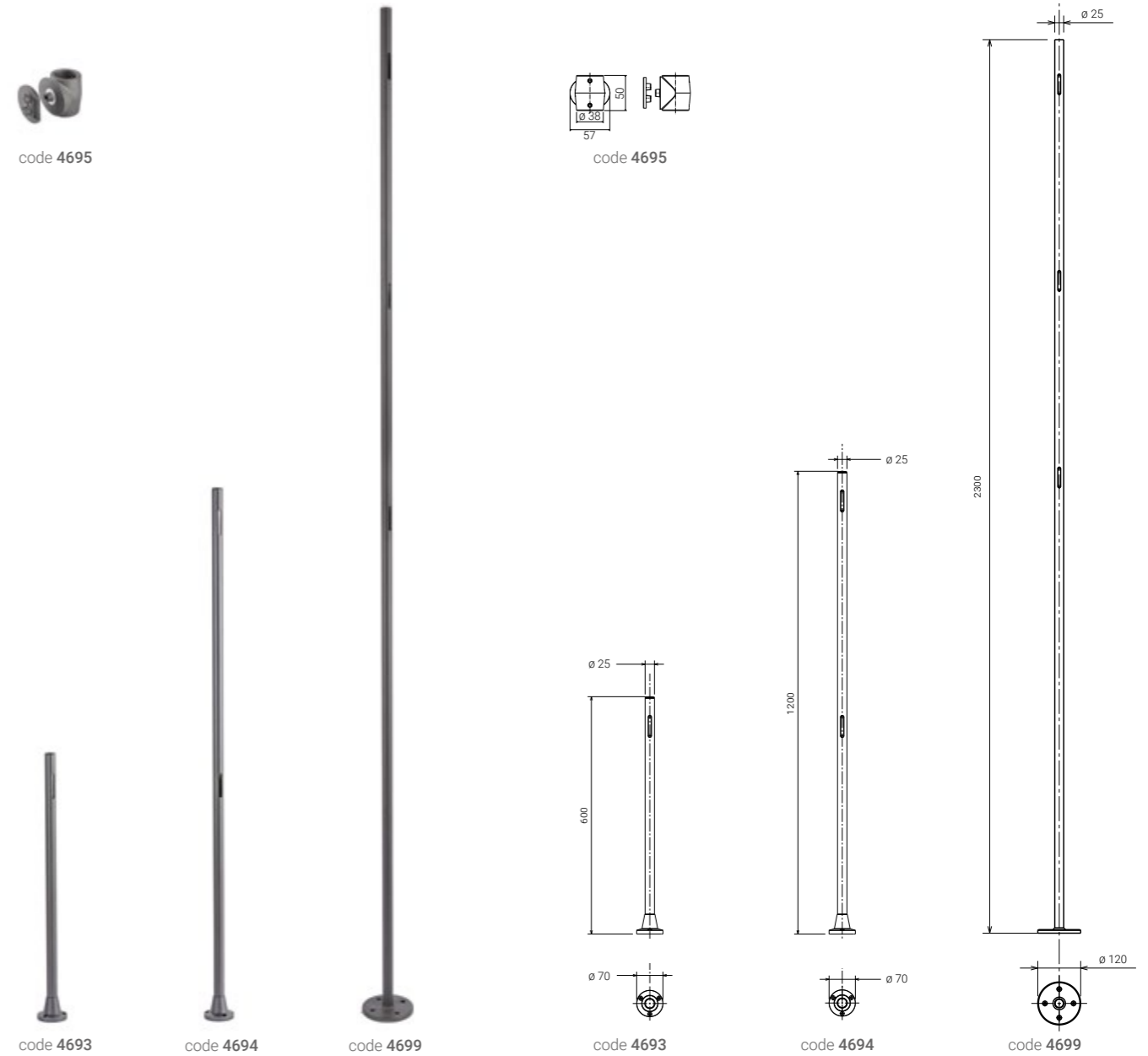

Code	Description
4693	Stelo H 600 mm (1 asola) in alluminio estruso, base in alluminio pressofuso / Stem H 600 mm (1 slot) in extruded aluminium, base in die-cast aluminium
4694	Stelo H 1200 mm (2 asole) in alluminio estruso, base in alluminio pressofuso / Stem H 1200 mm (2 slots) in extruded aluminium, base in die-cast aluminium
4699	Stelo H 2300 mm (3 asole) in acciaio, comprensivo di base / Stem H 2300 mm (3 slots) in steel, complete with base
4695	Raccordo scorrevole in alluminio pressofuso con relativa piastrina di fissaggio / Adjustable joint in die-cast aluminium with related fixing plate

4693, 4694 Max 2 cavi all'interno dello stelo / Max. 2 cables inside the stem

4699 Max 3 cavi all'interno dello stelo / Max. 3 cables inside the stem

4699 Si consiglia apparecchio CLOCK con cavo 7 m / CLOCK luminaire with 7 m cable is recommended

4694 Da montare obbligatoriamente con piastra 4697 / To be mandatorily installed with plate 4697

Su richiesta / On request

CO - corten

CLOCK

Accessori / Accessories



PICCHETTO / SPIKE



Code	Description	Ref. to
4696	Picchetto in policarbonato con piastra in acciaio inox AISI 304 / Spike in polycarbonate with plate in AISI 304 stainless steel	code 4693

PIASTRE TIRAFONDI / PLATES WITH ANCHORING SET



code 4697



code 5538

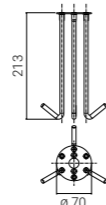

code 4697

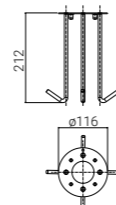

code 5538

Code	Description	Ref. to
4697	Piastra in acciaio inox AISI 304 con 3 tirafondi di ancoraggio / Plate in AISI 304 stainless steel with 3 ground anchors	code 4693 code 4694
5538	Piastra in acciaio inox AISI 304 con 4 tirafondi di ancoraggio / Plate in AISI 304 stainless steel with 4 ground anchors	code 4699

CASSAFORMA / IN-GROUND BOX

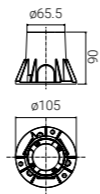

Code	Description	Ref. to
4698	Cassaforma per cablaggio interrato in tecnopolimero con anello in alluminio per fissaggio viti / In-ground box in technopolymer with aluminium ring to fix the screws	code 4693 code 4694

Accessorio opzionale per cablaggio stagno / Optional accessory for waterproof wiring (code 1941)



PROTO



PROTO è il proiettore tondo che porta avanti l'idea di Goccia Illuminazione di dare una forma bella ad una funzione buona. Con diverse potenze, numerose possibilità di impiego del flusso luminoso e di installazione trovano spazio nell'armonia delle proporzioni per applicazioni a parete, a terra e su palo. Fuori dal coro nel suo segmento, dove il risultato prevale sull'aspetto, PROTO garantisce grande efficacia illuminotecnica e si distingue con un design sinuoso e leggero. Lo studio delle forme contribuisce a sua volta all'ottimizzazione tecnica dello spazio superiore per la dissipazione, con la copertura lenticolare per far defluire l'acqua e con l'innesto dello snodo per facilitare l'orientamento verticale. I materiali selezionati e la qualità delle finiture completano la resistenza della struttura della lampada e il suo valore estetico. Così si aggiungono nuove possibilità di applicazione rispetto alle canoniche, per cui PROTO esprime una natura versatile - un proiettore a tutto tondo.

PROTO is the round projector that carries on Goccia Illuminazione's idea of giving a nice shape to a good function. With different powers, numerous possibilities of using the luminous flux find space in the harmony of proportions for wall, ground and pole applications. Out of the box in its category, where the result prevails over the appearance, PROTO guarantees great lighting effectiveness and stands out with a sinuous and slender design. The study of the shape contributes to the technical optimization of the upper space for dissipation, with the lenticular cover to drain the water and with the joint to facilitate vertical orientation. The selected materials and the quality of the finishes complete the resistance of the lamp structure and its aesthetic value. Thus new application possibilities are added compared to the canonical ones, whereby PROTO expresses a versatile nature - an all-round projector.

PROJECTORS



PROTO



PROTO
STRADA

PROTO

Struttura

- Corpo illuminante in alluminio pressofuso a basso tenore di rame. Il vetro frontale temprato trasparente ultrawhite è sigillato alla cornice di chiusura per consentire la massima tenuta
- Staffa di aggancio orientabile in alluminio pressofuso
- Viti laterali di fissaggio in acciaio inox in tinta

Structure

- Lighting body in low-copper grade die-cast aluminium. The transparent ultrawhite tempered front glass is sealed to the closing frame for maximum integrity
- Adjustable hooking bracket in die-cast aluminum
- Color matching side fixing screws in stainless steel

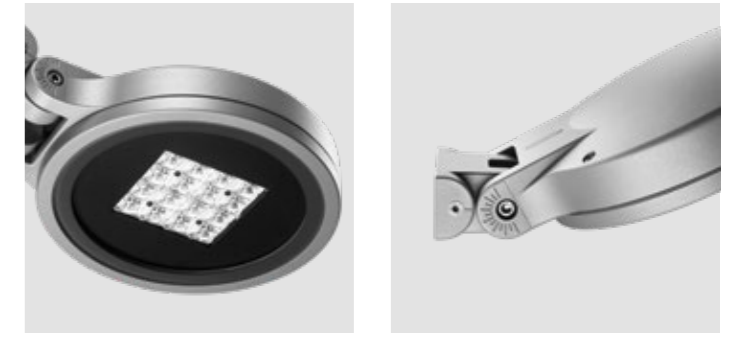
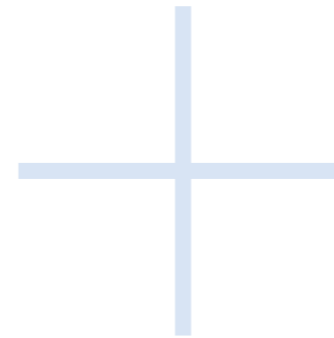

Estetico ed eclettico

PROTO è un proiettore che si inserisce propositivamente in chiave estetica e da qui definisce il suo valore di applicazione tecnica, declinando la funzione illuminotecnica con una scelta mirata di ottiche e di lenti.

Aesthetic and eclectic

PROTO is a projector for a purposeful use in an aesthetic key and from here defines its technical application value, declining the lighting function with a targeted choice of optics and lenses.



PROTO

- Moduli LED a tensione di rete
- Lenti tonde simmetriche

PROTO

- Mains voltage LED modules
- Round symmetrical lenses

PROTO STRADA

- Moduli LED altamente performanti
- Driver incorporato
- Lenti STRADA simmetriche e asimmetriche

PROTO STRADA

- Highly performing LED modules
- Driver incorporated
- Symmetrical and asymmetrical STRADA lenses



Varietà di applicazione

Tutte le modalità di impiego, dalla facciata agli altri spazi dell'architettura, si completano con l'applicazione su palo. L'attacco per pali Ø 60 e 76 mm consente l'installazione singola o doppia contrapposta, anche sui pali della serie PROTO per l'illuminazione di aree aperte e percorsi.

Variety of application

All the ways of installation, from the facade to different architectural spaces, are completed with the application on the pole. The connection for Ø 60 and 76 mm poles allows single or double opposed installation, even on PROTO series poles for illumination of open areas and paths.



PROTO

Proiettori / Projectors



PROTO

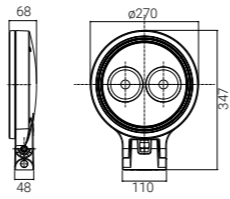

Code	
4935	● AN - anthracite 3K - 3000K
4936	● AG - aluminium grey 4K - 4000K

Lamp	W	Lm LED	Real Lm	Optic
LED	20	2200	1500	40°
	30	3150	2100	

Ottiche opzionali / Optional optics
12° (code + 12), 90° (code + 90)

Modulo LED a tensione di rete, compatibile con dimmer a taglio di fase /
Mains voltage LED module, compatible with most phase-cut dimmers

Fornito con 1 m di cavo / 1 m cable included

Eventuale protettore di sovratensioni da ordinare separatamente / Optional SPD to
be ordered separately (page 327)

Su richiesta / On request

2700K (code + 27K)

3 m di cavo per installazione su palo / 3 m cable for pole mounting (code + MT3)

PROTO STRADA

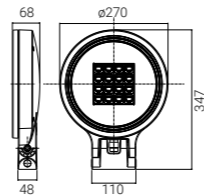

Code	
4937	● AN - anthracite 3K - 3000K
4938	● AG - aluminium grey 4K - 4000K

Lamp	W	Lm LED	Real Lm	Optic
LED	25	3008	2626	100° symmetric
	35	4212	3352	

Ottiche opzionali / Optional optics
vedi dettagli / see details (page 123)

- simmetrica / symmetric 17° (code + 01)
- asimmetrica / asymmetric 150° x 45° (code + 02), 90° x 30° (code + 03),
120° x 45° (code + 04), 150° x 70° (code + 05)

Fornito con 1 m di cavo / 1 m cable included

Eventuale protettore di sovratensioni da ordinare separatamente / Optional SPD to
be ordered separately (page 327)

Su richiesta / On request

Versione dimmerabile / Dimmable version

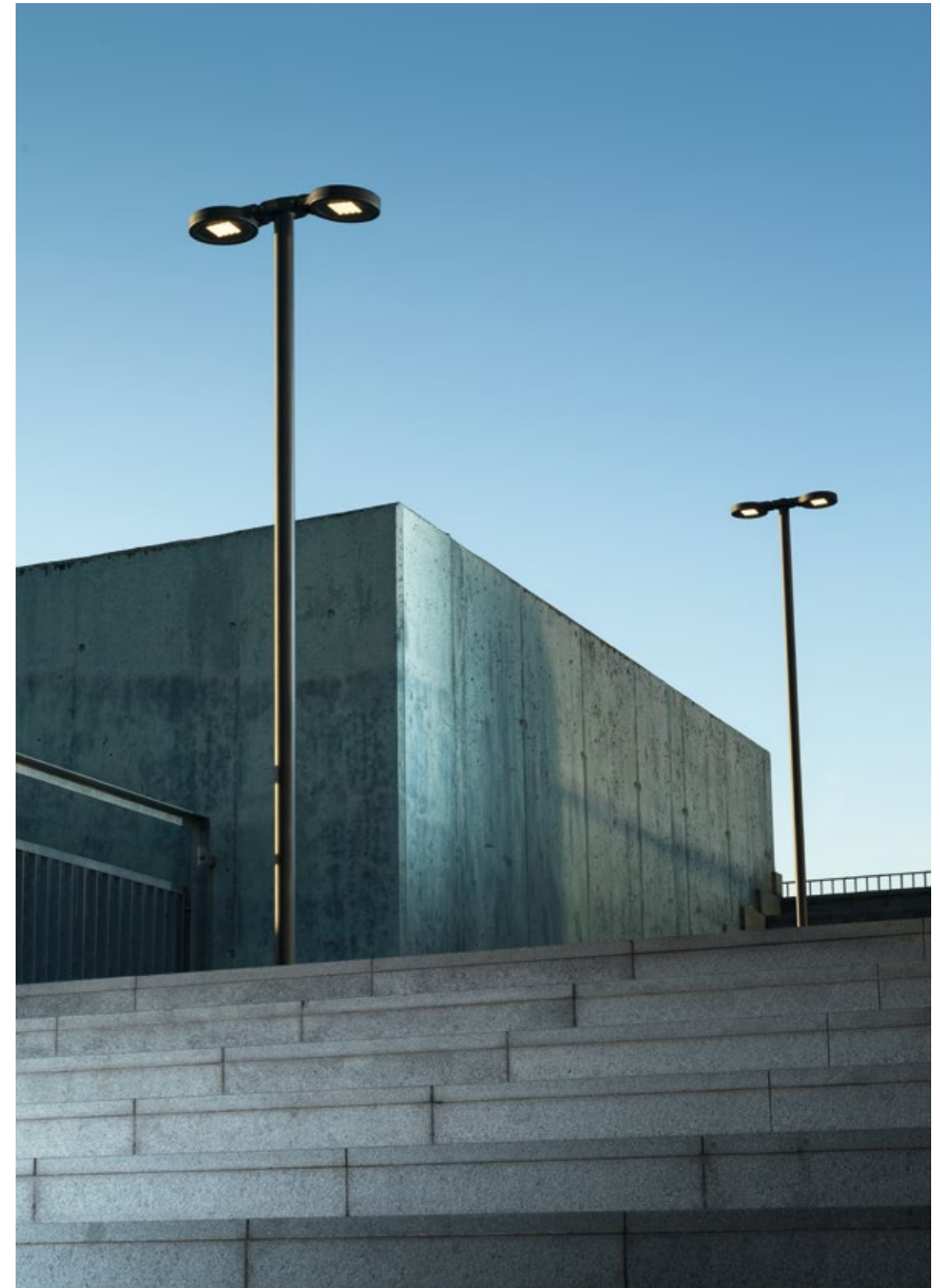



PROTO STRADA OTTICHE / OPTICS

SIMMETRICHE / SYMMETRIC

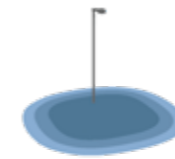

Lumen output: 3352 lm

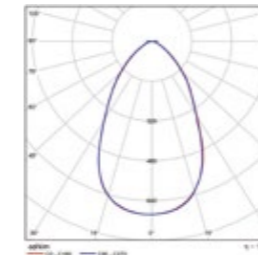

100° simmetrica / symmetric (standard code)
illuminazione uniforme / uniform lighting



Lumen output: 3958 lm

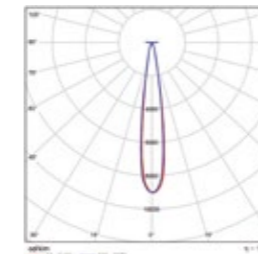

17° simmetrica / symmetric (code + 01)
illuminazione d'accento e di dettaglio / accent and detail lighting

ASIMMETRICHE / ASYMMETRIC



Lumen output: 3330 lm

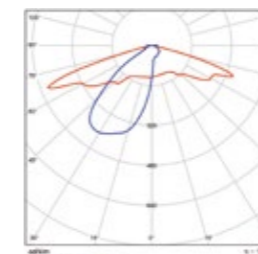

150° x 45° asimmetrica ciclopedonale / asymmetric cycle or pedestrian path (code + 02)
illuminazione per zone di transito, con interdistanza elevata / lighting for transit areas, with high interdistance



Lumen output: 3420 lm

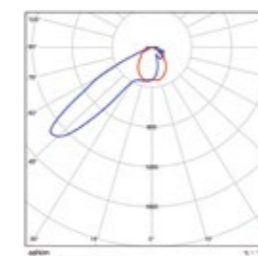

90° x 30° asimmetrica rettangolare / rectangular asymmetric (code + 03)
illuminazione di profondità, come aree gioco o attraversamenti pedonali / in-depth lighting, such as play areas or pedestrian crossings

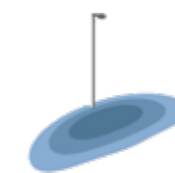

Lumen output: 3277 lm

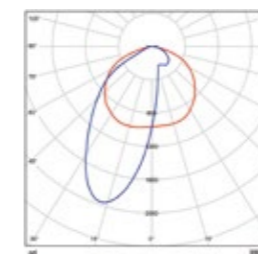

120° x 45° asimmetrica perimetrale / perimeter asymmetric (code + 04)
illuminazione di spazi ampi, parcheggi, aree di accesso, di carico e scarico / lighting of large spaces, car parks, accesses, loading and unloading zones

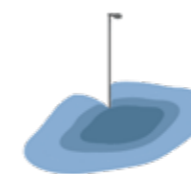

Lumen output: 3305 lm

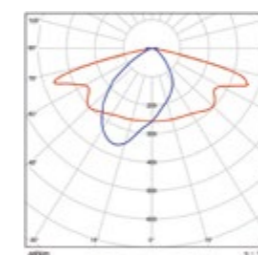

150° x 70° asimmetrica stradale / asymmetric street lighting (code + 05)
illuminazione di viabilità secondaria, residenziale e a basso flusso motorizzato; la presenza di backlight (20°) permette di illuminare anche spazi retrostanti la carreggiata, come marciapiedi e percorsi ciclabili / lighting of secondary, residential and low-flow motorized roads; 20° backlight allows to illuminate spaces behind the carriageway, such as pavements and cycle paths

Lumen output code 4938

ATTACCO PALI / POLES CONNECTION



code 5061

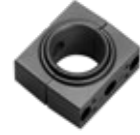

code 5062

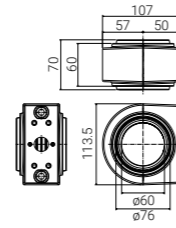

code 5061

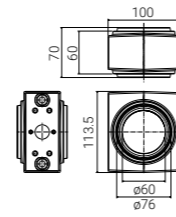

code 5062

Code

Description

5061	● AN - anthracite
5062	

Attacco singolo in alluminio pressofuso per palo Ø 60 - 76 mm / Die-cast aluminium single connection for Ø 60 - 76 mm pole
Attacco doppio in alluminio pressofuso per palo Ø 60 - 76 mm / Die-cast aluminium double connection for Ø 60 - 76 mm pole

PALI / POLES

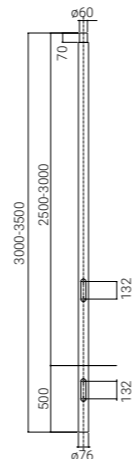

Code

H

Description

3504	● AN - anthracite
3505	

3000 mm (2500 mm fuori terra / above ground)	Palo liscio in acciaio Ø 76 mm ricavato da tubo elettrosaldato, zincato a caldo e verniciato. Completo di foro ingresso cavi, attacco di messa a terra e asola con portella e morsetti. Codolo superiore di installazione Ø 60 mm / Smooth pole Ø 76 mm in steel obtained from electro-welded tube, hot-dip galvanized and painted. Complete with cable entry, earthing connection and slot with door and terminal block. Top pole reduction Ø 60 mm
3500 mm (3000 mm fuori terra / above ground)	



TORRETTE
MULTIFUNZIONE

GARDEN POWER
POINTS

SERVER POINT



Distribuire la luce, coordinare comodamente energia, accessi, antifurto e tutti i comandi di domotica o con sensore di rilevamento della presenza dall'esterno. Questo è possibile con SERVER POINT, la torretta di distribuzione modulare dal design pulito e curato di Goccia Illuminazione. Disponibile in due altezze, SERVER POINT è attrezzato con 2 prese Schuko o industriali CEE 17 e predisposto ad accogliere da 4 a 12 moduli opzionali della serie Living International, Light e Light Tech di BTicino, a cui è possibile aggiungere un utile faretto LED segnapasso ed un rilevatore di presenza. La struttura in alluminio coniuga la resistenza con l'eleganza delle finiture.

Distribute the light, conveniently coordinate energy, access, anti-theft systems and all home automation, or with PIR sensor, outdoors. This is possible with SERVER POINT, the modular distribution tower with a clean and well-finished design by Goccia Illuminazione. Available in two heights, SERVER POINT is equipped with 2 Schuko or industrial CEE 17 sockets and designed to accommodate from 4 to 12 optional modules from the Living International, Light and Light Tech series by BTicino, to which it is possible to add a useful LED path marker and a PIR sensor. The aluminum structure combines resistance with the elegance of the finishes.

GARDEN POWER POINTS



SERVER POINT
1



SERVER POINT
1



SERVER POINT
2

SERVER POINT

Rilevatore di presenza

Possibilità di installare, in alternativa allo sportello porta prese, il rilevatore di presenza Goccia Illuminazione (opzionale). Se una persona o un veicolo entrano nel campo del sensore, viene comandata automaticamente l'accensione del faretto LED del SERVER POINT o una qualunque altra utenza domestica: lampade da giardino, cancello elettrico, porte automatiche, ecc. Sono possibili tre regolazioni: luminosità crepuscolare per regolare l'orario di funzionamento, area di rilevamento, temporizzazione dell'accensione.

PIR sensor

Option of installing a Goccia Illuminazione PIR sensor (optional), in a special space, instead of the sockets door. When somebody enters in the area is detected by the PIR sensor, the switch comes on to introduce a new function: light to the LED in the same pole or to the house lights or what else. Three regulations are available: detection area, switching timing and daylight.



LED segnapasso

È possibile aggiungere un utile LED segnapasso a tenuta stagna (opzionale).

LED path marker

A useful watertight LED path marker can also be added (optional).

* Alluminio estruso con piede e testa in pressofusione

Extruded aluminium with die-cast base and head

Doppia scatola cablaggio: comandi luce + energia / Dual wiring box: lighting + energy control

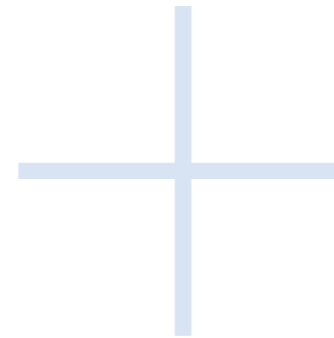

Struttura bifacciale

Doppi ingressi sui due lati, 4/8 moduli.

Two-sided structure

Double entries on two sides, 4/8 units.

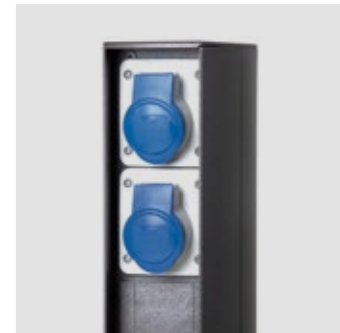

Dotazione prese

Fornito con due prese standard tedesco della serie Living International, Light e Light Tech di BTicino, oppure due prese industriali CEE 17. Gli sportelli liberi possono essere utilizzati per inserire altri frutti di servizio della serie Living International (interruttori/deviatori/pulsanti/interruttori automatici).

Sockets supplied

Equipped with two German standard sockets from the Living International, Light and Light Tech series by BTicino, or two industrial CEE 17 sockets. The free panels can be used to insert other Living International series service products (switches/diverters/buttons/automatic switches).



SERVER POINT

Torrette multifunzione / Garden power points



SERVER POINT 1

IP 55

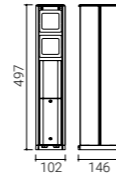

Code

Description

5301	GR - graphite
------	---------------

Struttura bifacciale con due sportelli a molla contenenti 2 prese standard Tedesco della serie Living International, Light e Light Tech di BTicino, 2 sportelli vuoti addizionali sul retro e due cassette di derivazione complete di morsettiera / Two-sided structure with two spring-loaded panels containing 2 German standard sockets from the Living International, Light and Light Tech series by BTicino, 2 additional empty panels on the back and two switching boxes complete with terminal board

SERVER POINT 1 - CEE 17

IP 44

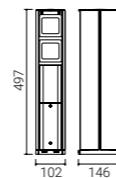

Code

Description

5303	GR - graphite
------	---------------

Struttura bifacciale con due sportelli a molla contenenti 2 prese industriali CEE 17 16A 220-250V 50/60Hz, due sportelli vuoti addizionali sul retro e due cassette di derivazione complete di morsettiera / Two-sided structure with two spring-loaded panels containing 2 industrial CEE 17 16A sockets 220-250V 50/60Hz, 2 additional empty panels on the back and two switching boxes complete with terminal board

Su richiesta / On request

Prese industriali / Industrial sockets 3P+T 380-415V 50/60Hz

SERVER POINT 2

IP 55

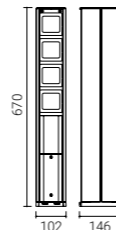

Code

Description

5302	GR - graphite
------	---------------

Struttura bifacciale con due sportelli a molla contenenti 2 prese standard Tedesco della serie Living International, Light e Light Tech di BTicino, 2 sportelli vuoti addizionali frontali, 4 sul retro e due cassette di derivazione complete di morsettiera / Two-sided structure with two spring-loaded panels containing 2 German standard sockets from the Living International, Light and Light Tech series by BTicino, 2 additional empty panels in the front, 4 on the back and two switching boxes complete with terminal board

SERVER POINT

Accessori / Accessories



LED SEGNAPASSO / RECESSED LED PATH MARKER

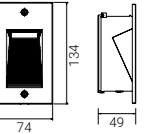

Code

Lamp

W

Lm LED

Real Lm

Optic

5315	GR - graphite	3K - 3000K 4K - 4000K
------	---------------	--------------------------

LED	4,5	265	168	asym.
-----	-----	-----	-----	-------

RILEVATORE DI PRESENZA / PIR SENSOR

IP 65

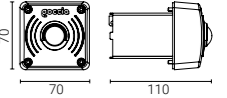

Code

Description

5308	GR - graphite
------	---------------

Rilevatore di presenza a raggi infrarossi con tre regolazioni: luminosità crepuscolare, temporizzazione, area di rilevamento / PIR sensor with three regulations: time, area, daylight

Collegabile al cod. 5315 o altri apparecchi in linea / Connectable to code 5315 or other luminaires in line

Accessorio da inserire su SERVER POINT al posto dello sportello porta prese / To be inserted on SERVER POINT instead of the sockets door

Nello sportello contrapposto non è possibile inserire prese o interruttori / The opposite door cannot contain any sockets or switches

PIASTRA TIRAFONDI / PLATE WITH ANCHORING SET

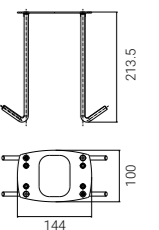

Code

Description

5309	Piastra inox con tirafondi per ancoraggio al terreno / Stainless Steel plate with ground anchoring set
------	--



STANDING



Il design essenziale, la costruzione interamente in alluminio e la sorgente luminosa LED che disegna la forma conferiscono a STANDING un carattere deciso, capace allo stesso tempo di inserirsi con discrezione nel contesto. La struttura robusta ha consentito di ridurre l'ingombro e di potersi fissare su di una base senza sporgenze.

STANDING è stata progettata per diffondere la luce verso il basso, prestandosi ad illuminare percorsi, camminamenti e viali di accesso, ma con la possibilità di implementare una luce posteriore d'effetto diffusa mediante un modulo LED aggiuntivo.

The essential design, the construction entirely in aluminum and the LED light source that draws the shape give STANDING a decisive character, able at the same time to fit discreetly into the context. The robust structure made it possible to reduce the overall dimensions and to be fixable on a base without protrusions. STANDING was designed to diffuse the light downwards, lending itself to illuminate paths, walkways and access avenues, but with the possibility of implementing a diffused effect rear light using an additional LED module.

GARDEN POST



STANDING

STANDING

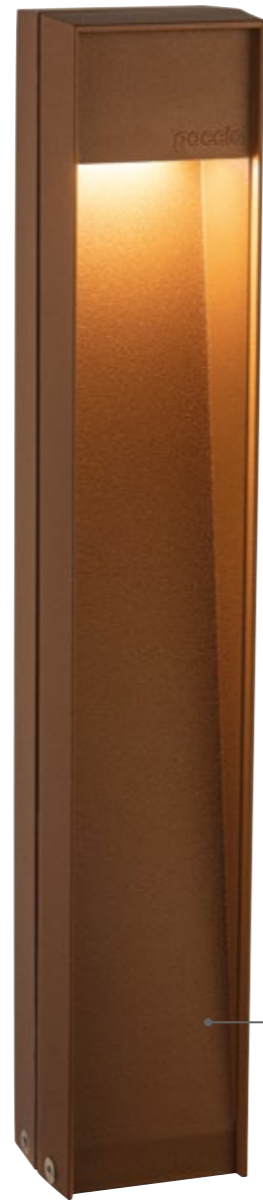

Luce posteriore

La struttura consente l'inserimento sul retro di un secondo corpo illuminante a luce radente e diffusa.

Back light

On the lower back the structure allows to insert a second luminaire with a diffused light.

Struttura

Interamente in lega di alluminio primario a basso tenore di rame. Luce frontale, protetta da aletta antiabbagliamento, progettata per illuminare camminamenti, passaggi e vialetti.

Structure

Fully made of primary aluminium alloy with low copper content. The front light, protected by an antidazzle louvre, is designed for walkways and paths.

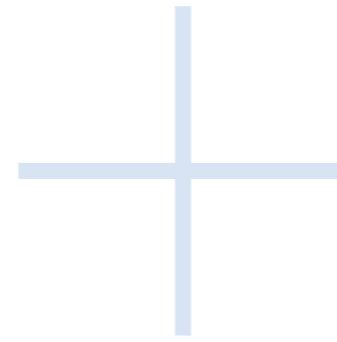

Aletta antiabbagliante

La luce LED frontale viene direzionata verso il basso ed è protetta da aletta antiabbagliante.

Downward light

The front LED light is directed downwards and is protected by an antidazzle louvre.



Cablaggio interno

Il cablaggio è interno alla struttura tramite gli appositi giunti forniti separatamente. Con il giunto stagno a Y è possibile effettuare il cablaggio passante.

Internal wiring

The wiring is inside the pole. The connections are supplied separately. The optional Y-connector allows through wiring.



STANDING

Palo da giardino / Garden post



PALO / POST

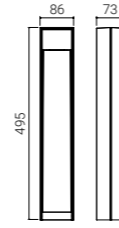

Code	
● AN - anthracite	3K - 3000K 4K - 4000K
● AG - aluminium grey	
● CO - corten	

Lamp	W	Lm LED	Real Lm	Optic
LED	8	800	423	-

Modulo LED a tensione di rete, compatibile con dimmer a taglio di fase / Mains voltage LED module, compatible with most phase-cut dimmers

Su richiesta / On request

2700K (code + 27K)

● GR - graphite ● GM - metallized grey

STANDING

Accessori / Accessories



LUCE POSTERIORE / BACK LIGHT

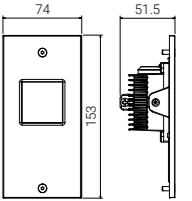
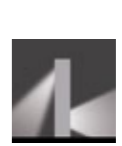

Code	
● AN - anthracite	3K - 3000K 4K - 4000K
● AG - aluminium grey	
● CO - corten	

Lamp	W	Lm LED	Real Lm	Optic
LED	8	800	423	-

Modulo LED a tensione di rete, compatibile con dimmer a taglio di fase / Mains voltage LED module, compatible with most phase-cut dimmers

Su richiesta / On request

2700K (code + 27K)

● GR - graphite ● GM - metallized grey



GIUNTI STAGNI / WATERPROOF CONNECTIONS

IP 68



code 1941



code 1942



code 1941

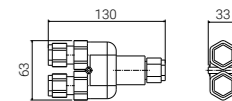

code 1942

Code

Description

1941	Connessione singola 3x2,5 mm ² IP68 / Single connector 3x2,5 mm ² IP 68
1942	Connessione entra-esce 3x2,5 mm ² IP68 / Through wiring connector 3x2,5 mm ² IP 68

TIRAFONDI / ANCHORING SET



Code

Description

5529	4 tirafondi in inox per ancoraggio al terreno / 4 stainless steel ground anchors
------	--



IANUS



La forma pura del bollard cilindrico viene intagliata in maniera scultorea e immediata per lasciar scaturire la luce. E la luce determina l'angolo del taglio e le proporzioni dell'intera composizione, per esprimersi al massimo e con eleganza.

IANUS è proposto da Goccia Illuminazione in biemissione o monodirezionale, con due diametri e diverse altezze, nelle resistenti e pregiate finiture.

La tecnologia ad alta efficienza delle sorgenti luminose si presta per molteplici tipi di installazione e versioni, fino a quella da arredo urbano IANUS URBAN, con le ottiche dedicate per l'ottimizzazione del flusso luminoso. Questa vocazione tecnica di grande attenzione all'effetto di luce mirato ed efficace rende IANUS uno strumento preciso per il progetto illuminotecnico di contesti architettonici privati residenziali e pubblici urbani.

The pure form of the cylindrical bollard is crafted in a sculptural and immediate way to let the light flow. And the light determines the angle of the cut and the proportions of the entire composition, to the maximum expression with elegance.

IANUS is proposed by Goccia Illuminazione in bi-emission or unidirectional, with two diameters and different heights, in resistant and precious finishes.

The high-efficiency technology of the light sources is suitable for multiple types of installation and versions, up to the IANUS URBAN street furniture, with dedicated optics for optimizing the luminous flux. This technical vocation of great attention to the targeted and effective light effect makes IANUS a precise tool for the lighting design of private residential and urban public architectural contexts.

POLES



IANUS 60



IANUS 120

URBAN LIGHTING



IANUS URBAN

IANUS 60

Struttura

- Testa-palo in lega di alluminio primario a basso tenore di rame
- LED schermato all'interno del diffusore
- Driver incorporato nel testa-palo

Structure

- Pole-top in primary low-copper grade aluminium alloy
- Shielded LED inside the diffuser
- Driver incorporated in the pole-top

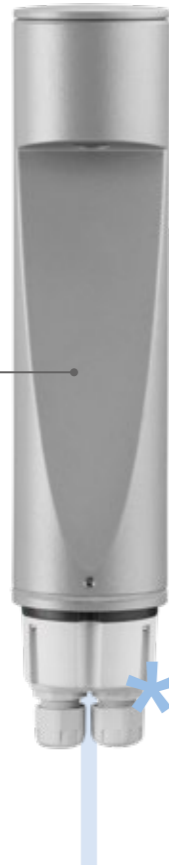

Il testa-palo è dotato di due pressacavi M16 per consentire l'alimentazione passante.

The pole-top is equipped with two M16 cable glands to allow through wiring.

Pali

Pali lisci in alluminio estruso.
Disponibili in 2 altezze: 375 mm e 800 mm.

Poles

Smooth poles in extruded aluminum.
Available in 2 heights: 375 mm and 800 mm.

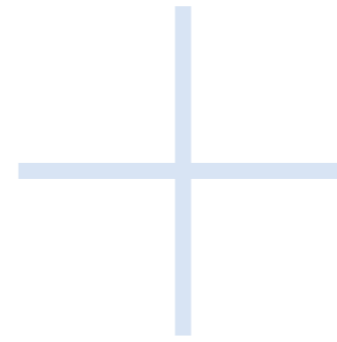

Purezza della forma

Il volume cilindrico pulito di IANUS 60 si esprime nel taglio della sorgente luminosa, per esaltare l'effetto del piano inclinato in un equilibrio di luci ed ombre. L'accuratezza del progetto permette di ottenerlo identico in modo speculare nella versione in biemissione.

Purity of shape

The clean cylindrical volume of IANUS 60 is expressed in the cut of the light source, to enhance the effect of the inclined plane in a balance of light and shadow. The accuracy of the project allows it to be identical in the double emission version specularly.

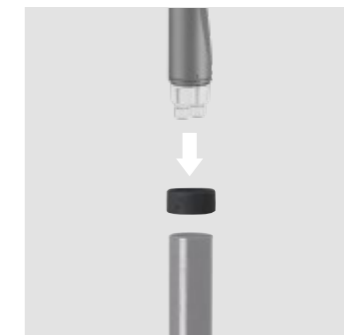

Adattatore per pali Ø 60 mm

Gli apparecchi IANUS 60 possono essere installati e fissati mediante uno speciale raccordo anche su qualsiasi palo di mercato di Ø 60 mm.

Adaptor for Ø 60 mm poles

The IANUS 60 luminaires can also be installed and fixed by means of a special adaptor on any standard Ø 60 mm pole.

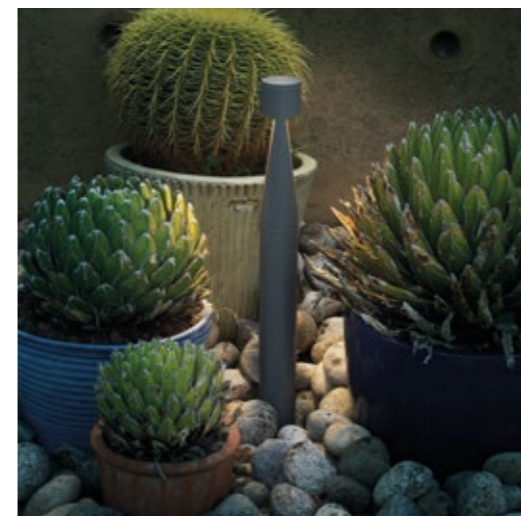

IANUS 60

Pali da giardino / Garden poles



CORPI LAMPADA / LIGHT BODIES Ø 60 mm

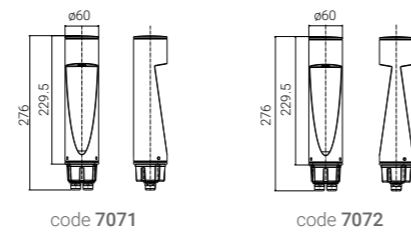

Code		
7071	● AN - anthracite	3K - 3000K
7072	● AG - aluminium grey	4K - 4000K

Lamp	W	Lm LED	Real Lm	Optic
LED	4,6	430	115	diffuse
	8	860	230	

Su richiesta / On request
 2700K (code + 27K)
 10+52V low voltage
 ● BR - bronze



IANUS 60

Accessori / Accessories



PALI / POLES



Code	H	Description
3401	375 mm	Palo liscio in alluminio estruso, comprensivo di basetta interna di ancoraggio in alluminio pressofuso / Smooth pole in extruded aluminium with incorporated internal fixing base in die-cast aluminium
3402	800 mm	

Si raccomanda l'installazione con piastra cod. 5518 /
 Installation with anchor plate code 5518 is recommended

Versione con base esterna / External ground fixing base version (page 181)



PIASTRA TIRAFONDI / PLATE WITH ANCHORING SET

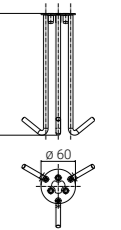

Code	Description
5518	Piastra inox con tirafondi per ancoraggio al terreno / Stainless steel plate with ground anchoring set

RACCORDO PER PALI STANDARD / ADAPTOR FOR STANDARD POLES Ø 60 mm

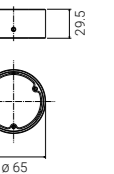

Code	Description
5506	Raccordo in alluminio primario pressofuso, adattabile a qualsiasi palo Ø 60 mm / Adaptor in die-cast primary aluminium, to be installed on any pole Ø 60 mm

IANUS 120

Struttura

- Interamente in lega di alluminio primario a basso tenore di rame
- Sorgente luminosa inserita all'interno dello schermo lenticolare in policarbonato opale fotoinciso per un'ampia e uniforme apertura della luce
- Viti di chiusura laterali in acciaio inox in tinta

Structure

- Entirely in primary low-copper grade aluminium alloy
- Light source inside the photo-etched lenticular opal diffuser for a wide and uniform light distribution
- Color matching side-locking stainless steel screws



Cablaggio stagno con spezzone di cavo in dotazione che alimenta il driver integrato. Secondo ingresso M16 disponibile per cablaggio aggiuntivo, posizionato nella parte inferiore del tappo di chiusura in tecnopolimero.

Watertight wiring through the supplied cable that powers the integrated driver. Further M16 entry for additional wiring, positioned in the lower part of the closing cap in technopolymer.

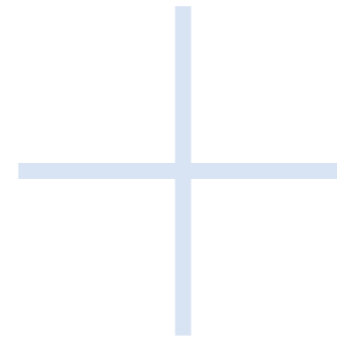

Monolitico

La semplicità della forma e delle linee pure di IANUS 120 ne conferiscono il carattere forte e di robustezza che viene concretizzato con la realizzazione tramite un unico stampo di pressofusione in lega di alluminio primario, riducendo inoltre al minimo le parti visibili.

Monolithic

The simplicity of the shape and pure lines of IANUS 120 give it a strong and robust character, which is materialized with the realization through a single die-casting mold in primary aluminum alloy, reducing the visible parts to a minimum.



Progettato per la resa luminosa

La ricerca geometrica e delle proporzioni ha consentito l'ideale posizionamento della sorgente luminosa di IANUS 120. La particolare forma del diffusore opalizzato permette di massimizzare l'output e l'apertura della luce.

Designed for luminous performance

The research of geometry and proportions allowed the ideal positioning of the IANUS 120 light source. The particular shape of the opalized diffuser allows to maximize the output and the width of the light.



IANUS 120

Pali da giardino e arredo urbano / Garden poles and urban lighting



IANUS 120 H 600

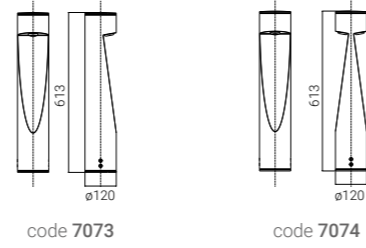

Code		
7073	● AN - anthracite	3K - 3000K
7074	● AG - aluminium grey	4K - 4000K

Lamp	W	Lm LED	Real Lm	Optic
LED	8	951	515	diffuse
	15	1902	1030	

Palo completo, cavo in dotazione / Complete fitting, cable supplied

Su richiesta / On request
 2700K (code + **27K**)
 Versione dimmerabile / Dimmable version
 ● BR - bronze

IANUS 120 H 1000

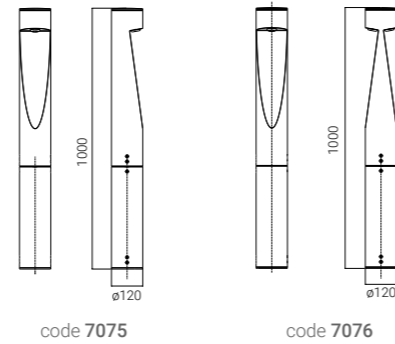
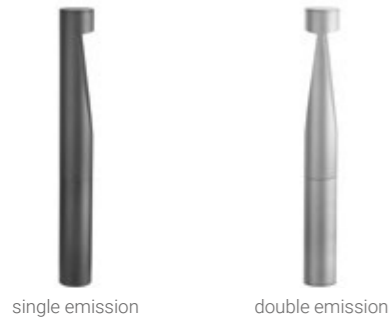

Code		
7075	● AN - anthracite	3K - 3000K
7076	● AG - aluminium grey	4K - 4000K

Lamp	W	Lm LED	Real Lm	Optic
LED	8	951	515	diffuse
	15	1902	1030	

Palo completo, cavo in dotazione / Complete fitting, cable supplied

Su richiesta / On request
 2700K (code + **27K**)
 Versione dimmerabile / Dimmable version
 ● BR - bronze

PIASTRA TIRAFONDI / PLATE WITH ANCHORING SET

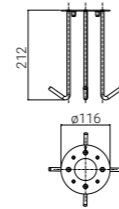

Code	Description
5538	Piastra inox con tirafondi per ancoraggio al terreno / Stainless steel plate with ground anchoring set

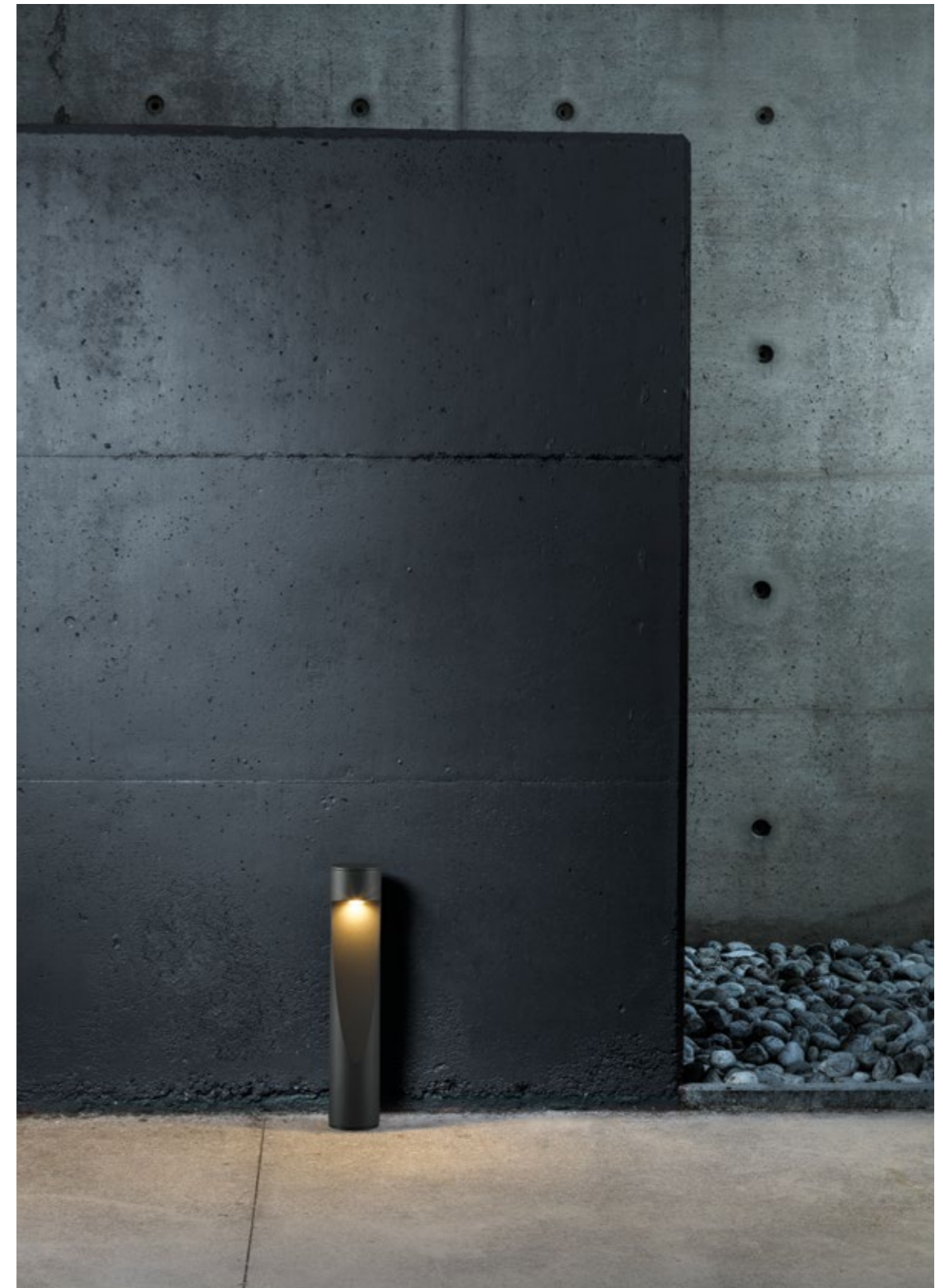



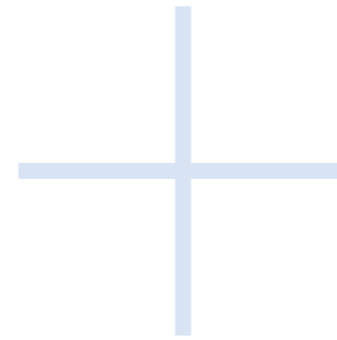

Struttura

- Corpo illuminante Ø 120 mm in alluminio pressofuso a basso tenore di rame accoppiato in continuità con palo in alluminio estruso
- Sorgente luminosa recessa per accogliere ottiche dedicate
- Schermo lenticolare in policarbonato fotoinciso
- Viti di chiusura laterali in acciaio inox in tinta

Structure

- Lighting body Ø 120 mm in low-copper grade die-cast aluminium coupled in continuity with extruded aluminum pole
- Recessed light source with dedicated lenses
- Photo-etched lenticular polycarbonate diffuser
- Color matching side locking stainless steel screws

Cablaggio stagno con spezzone di cavo in dotazione che alimenta il driver integrato. Secondo ingresso M16 disponibile per cablaggio aggiuntivo, posizionato nella parte inferiore del tappo di chiusura in tecnopolimero.

Watertight wiring through the supplied cable that powers the integrated driver. Further M16 entry for additional wiring, positioned in the lower part of the closing cap in technopolymer.

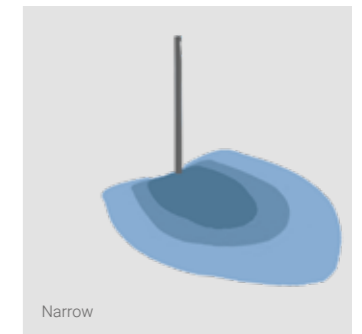
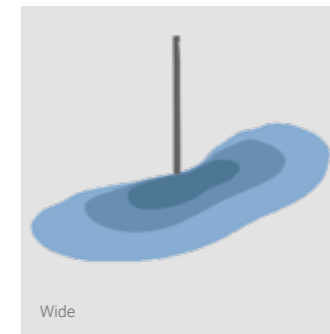
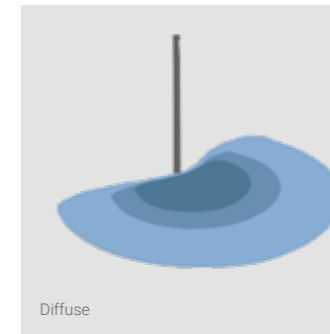

Illuminazione urbana

Per rispondere alle necessità di illuminazione cittadina e di contesti residenziali più estesi, IANUS URBAN abbina ai LED ad alto rendimento lenti e ottiche apposite per ottenere il risultato più corretto - sono disponibili fasci luminosi ad ampia diffusione e asimmetrici.

Urban lighting

To meet the needs of urban lighting and larger residential contexts, IANUS URBAN combines high-performance LEDs with special lenses and optics to obtain the best result - wide diffusion and asymmetric light beams are available.



Solidità di installazione

Abbinato al palo, IANUS URBAN nelle soluzioni mono- e bifacciali dispone di solide modalità di installazione con un'attenzione al risultato estetico, grazie all'interramento del palo o al basamento in superficie.

Solidity of installation

Combined with the pole, IANUS URBAN in single- and double-sided solutions allows solid ways of installation with a focus on the aesthetic result, thanks to the buriable pole mounting or to the surface mounting with base.

IANUS URBAN

Arredo urbano / Urban lighting



IANUS URBAN INTERRABILE / BURIABLE H 2400

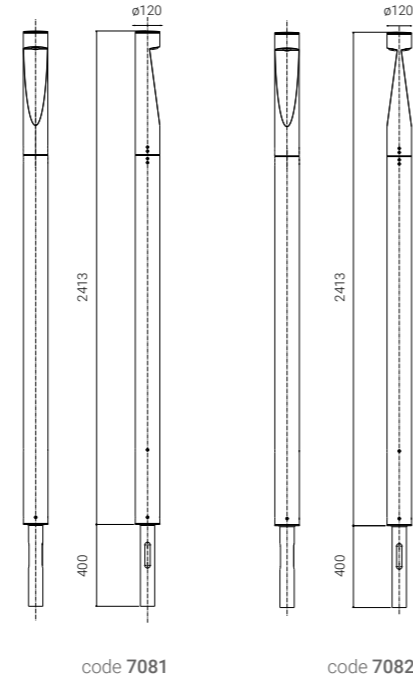

Code		
7081	● AN - anthracite	3K - 3000K
7082	● AG - aluminium grey	4K - 4000K

Ottiche opzionali / Optional optics
asimmetrica / asymmetric wide (code + **W**), narrow (code + **N**)

Palo completo con ancoraggio interrabile e cavo /
Complete fitting with buriable anchoring unit and cable

Eventuale protettore di sovratensioni da ordinare separatamente / Optional SPD to
be ordered separately (page 327)

Lamp	W	Lm LED	Real Lm	Optic
LED	16	1952	934	diffuse
	32	3904	1868	

Su richiesta / On request

2700K (code + **27K**)

Versione dimmerabile / Dimmable version

● BR - bronze

IANUS URBAN

Arredo urbano / Urban lighting



IANUS URBAN CON BASAMENTO / WITH BASE H 2400

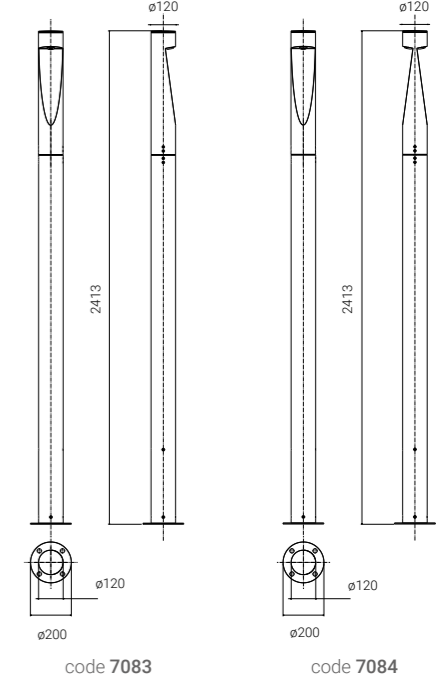

Code		
7083	● AN - anthracite	3K - 3000K
7084	● AG - aluminium grey	4K - 4000K

Ottiche opzionali / Optional optics
asimmetrica / asymmetric wide (code + **W**), narrow (code + **N**)

Palo completo con basamento e cavo / Complete fitting with base and cable

Eventuale protettore di sovratensioni da ordinare separatamente / Optional SPD to
be ordered separately (page 327)

Lamp	W	Lm LED	Real Lm	Optic
LED	16	1952	934	diffuse
	32	3904	1868	

Su richiesta / On request

2700K (code + **27K**)

Versione dimmerabile / Dimmable version

● BR - bronze

TIRAFONDI / ANCHORING SET

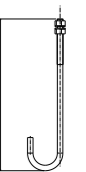

Code	Description	Ref. to
5527	4 tirafondi in acciaio per ancoraggio al terreno / 4 steel ground anchors	code 7083 code 7084



T-LUX



Nella continuità creativa dell'esperienza nella luce per esterni Goccia Illuminazione porta avanti la sua storia con un altro capitolo, la serie T-LUX. Essenziale nella semplicità delle forme e contraddistinta dalla riconoscibilità dell'elemento che completa la composizione come una T - questo è il disco compatto della sorgente luminosa che nelle diverse applicazioni e dimensioni si coniuga con la propria necessità illuminotecnica, offrendo inoltre un effetto scenico discreto e puntuale. Concepita per gli spazi all'aperto alla ricerca di un comfort e una vivibilità assimilabile a quella degli ambienti interni, la natura estetica di T-LUX ha beneficiato di questa influenza di tipo decorativo nelle forme e nelle finiture, esaltate dalla combinazione dei colori. Questa è dunque confluita in due versioni su palo, uno stelo ed un bollard, ed in quella a parete, senza perdere il soprannome intuitivo ed evocativo che le ha accompagnate per tutte le fasi di progetto, rispettivamente: STAN, OLLIE e BOWLER o "bombetta".

In the creative continuity of the experience in outdoor lighting Goccia Illuminazione develops its story with another chapter, the T-LUX series. Essential in the simplicity of the shapes and distinguished by the recognizability of the element completing the composition as a T - this is the thin disk of the light source which is combined in different applications and sizes with its own lighting needs, also offering a discreet and precise scenic effect. Designed for outdoor spaces in search of comfort and liveability comparable to that of indoor environments, the aesthetic nature of T-LUX has benefited from this decorative influence in the shapes and finishes, enhanced by the combination of colors. This is therefore merged into two versions on pole, a stem and a bollard, and in the wall version, without losing the intuitive and evocative nickname that accompanied them for all the project phases, respectively: STAN, OLLIE and BOWLER.

POLES



T-LUX OLLIE



T-LUX STAN

WALL EFFECTS



T-LUX BOWLER

T-LUX OLLIE

Diffusore in policarbonato fotoinciso per prevenire l'abbagliamento orizzontale e garantire un elevato output verso il basso.

Photo-etched polycarbonate **diffuser** to prevent horizontal glare and to grant high output downwards.

Disco superiore dissipante in alluminio pressofuso a basso tenore di rame; la particolare forma convessa evita il ristagno dell'acqua.

Dissipating **upper disc** in die-cast aluminium with low copper content; the particular convex shape avoids water stagnation.

Cono in alluminio pressofuso a basso tenore di rame; maggiore diffusione della luce nella finitura grigio alluminio, minima dispersione verso l'alto nella finitura antracite.

Cone in die-cast aluminium with low copper content; higher light diffusion in the aluminium grey finish, minimum upward light dispersion in the anthracite finish.

Cablaggio stagno con spezzone di cavo in dotazione che alimenta il driver integrato. Secondo ingresso M16 disponibile per cablaggio aggiuntivo, posizionato nella parte inferiore del tappo di chiusura in tecnopolimero.

Watertight **wiring** through the supplied cable that powers the integrated driver. Further M16 entry for additional wiring, positioned in the lower part of the closing cap in technopolymer.

Robusto e versatile

La versatilità di installazione di OLLIE si articola in tre altezze di pali in alluminio estruso a disposizione per diversi scenari di illuminazione, con un montaggio robusto e semplice.

Robust and versatile

The versatility of OLLIE's installation is divided into three heights of extruded aluminum poles available for different lighting scenarios, with a robust and simple mounting.

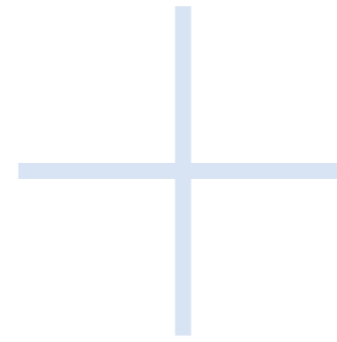

Bollard con brio

Nell'accoppiamento tra il palo Ø 120 mm e il disco superiore Ø 150 mm OLLIE definisce la sua qualità illuminotecnica ed estetica, che trova la sua massima espressione nel cono di raccordo - un solido bollard che mantiene una leggerezza dello stile.

Bollard with brio

In the coupling between the Ø 120 mm pole and the Ø 150 mm upper disc OLLIE defines its lighting and aesthetic quality, which finds its maximum expression in the connection cone - a solid bollard that maintains a lightness of style.



Carattere nella composizione

Diventa versatile anche la scelta del carattere che OLLIE può assumere, con una combinazione delle finiture bicromatica o in tinta unita, per accentuare l'effetto della luce o inserirsi discretamente nei diversi contesti.

Character in the composition

The choice of character that OLLIE can take on also becomes versatile, with a combination of two-tone or solid color finishes, to accentuate the light or discreetly fit into different contexts.

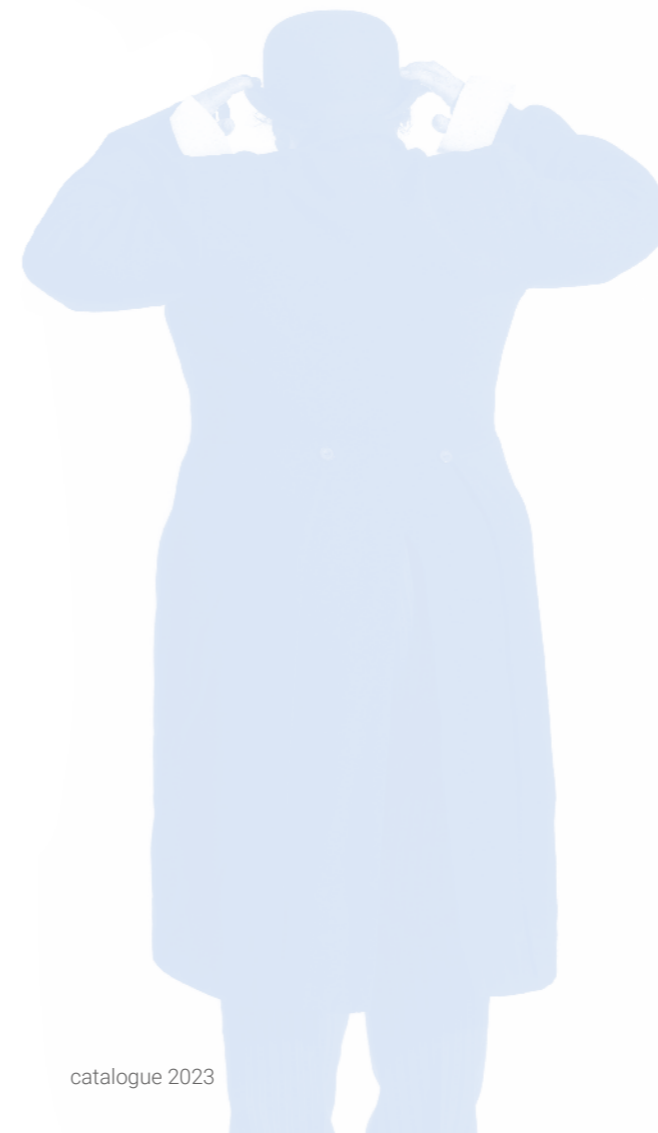

T-LUX OLLIE

Pali / Bollards



CORPO LAMPADA / LIGHT BODY



Code	Lamp	W	Lm LED	Real Lm	Optic
5553	LED	12,5	1725	968	diffuse

Code	Color	Temp
AN	anthracite	3K - 3000K
AG	aluminium grey	4K - 4000K
AGAN	aluminium grey + anthracite	
ANAG	anthracite + aluminium grey	

Cavo in dotazione / Cable supplied

Su richiesta / On request

2700K (code + **27K**)

24V low voltage (code + **24V**)

Versione dimmerabile / Dimmable version



T-LUX OLLIE

Accessori / Accessories



PALI / POLES



Code	H	Description
3601	200 mm	Palo liscio in alluminio estruso, comprensivo di basetta interna di ancoraggio in alluminio pressofuso / Smooth pole in extruded aluminium with incorporated internal fixing base in die-cast aluminium
3602	400 mm	
3603	700 mm	

PIASTRA TIRAFONDI / PLATE WITH ANCHORING SET

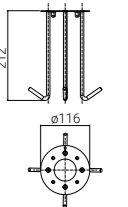

Code	Description
5538	Piastra inox con tirafondi per ancoraggio al terreno / Stainless steel plate with ground anchoring set

SAGOMATORE / BEAM LIMITER

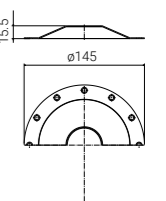

Code	Description
5555	Sagomatore 180° in alluminio / Aluminium 180° beam limiter

T-LUX STAN

Diffusore in policarbonato fotoinciso per prevenire l'abbagliamento orizzontale e garantire un elevato output verso il basso, grazie anche al diametro del modulo LED a tensione di rete che occupa interamente lo spazio interno dedicato.

Photo-etched polycarbonate **diffuser** to prevent horizontal glare and to grant high output downwards, thanks also to the diameter of the mains voltage LED module, that completely occupies the dedicated internal space.



Disco superiore dissipante in alluminio pressofuso a basso tenore di rame; la particolare forma convessa evita il ristagno dell'acqua.

Dissipating **upper disc** in die-cast aluminium with low copper content; the particular convex shape avoids water stagnation.

Cablaggio stagno con spezzone di cavo in dotazione.

Watertight **wiring** through the cable supplied.

Montaggio semplificato grazie al raccordo filettato, senza viti a vista.

Easier installation thanks to the threaded connection, without visible screws.

Steli

Steli in alluminio estruso disponibili in tre altezze: 300, 600 e 900 mm. La base in alluminio pressofuso consente l'installazione con picchetto, piastra tirafondi o cassaforma.

Stems

Extruded aluminium stems available in three heights: 300, 600 and 900 mm. The die-cast aluminium base allows installation with spike, anchoring plate or in-ground box.

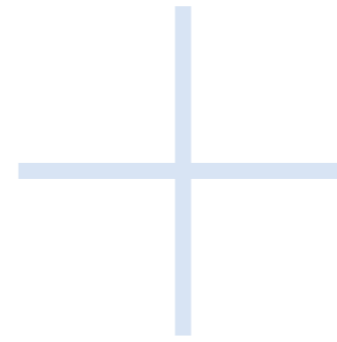

Stelo di luce

Un'illuminazione mirata e uniforme che scaturisce dalla forma esile di STAN, in sintonia con un paesaggio arboreo o con un ambiente costruito definito e minimale.

Stem of light

A targeted and uniform lighting that comes from the slender shape of STAN, in harmony with an arboreal landscape or with a defined and minimal built environment.



Stelo versatile

Per calibrare l'effetto luminoso nel contesto STAN dispone di lampade in due diametri e di pali in diverse altezze, le cui proporzioni consentono anche combinazioni multiple espressive.

Versatile stem

To calibrate the lighting effect in the context, STAN has lamps in two diameters and poles in different heights, whose proportions also allow multiple expressive combinations.



T-LUX STAN

Steli da giardino / Garden stems



CORPO LAMPADA / LIGHT BODY Ø 150 mm

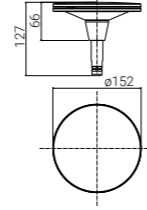

Code

5551		AN - anthracite	3K - 3000K
		AG - aluminium grey	4K - 4000K

Fornito con 1,5 m di cavo / 1,5 m cable included

Modulo LED a tensione di rete, compatibile con dimmer a taglio di fase /
Mains voltage LED module, compatible with most phase-cut dimmers
Compatibile con sagomatore / Compatible with beam limiter (code 5555)

Lamp	W	Lm LED	Real Lm	Optic
LED	10	1150	753	diffuse

Su richiesta / On request

2700K (code + **27K**)
24V low voltage (code + **24V**)
Lunghezza cavo 7 m / 7 m cable length (code + **MT7**)
 CO - corten **VE** - green

CORPO LAMPADA / LIGHT BODY Ø 200 mm

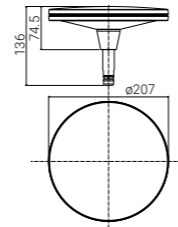

Code

5552		AN - anthracite	3K - 3000K
		AG - aluminium grey	4K - 4000K

Fornito con 1,5 m di cavo / 1,5 m cable included

Modulo LED a tensione di rete, compatibile con dimmer a taglio di fase /
Mains voltage LED module, compatible with most phase-cut dimmers

Lamp	W	Lm LED	Real Lm	Optic
LED	20	2300	1602	diffuse

Su richiesta / On request

2700K (code + **27K**)
24V low voltage (code + **24V**)
Lunghezza cavo 7 m / 7 m cable length (code + **MT7**)
 CO - corten **VE** - green

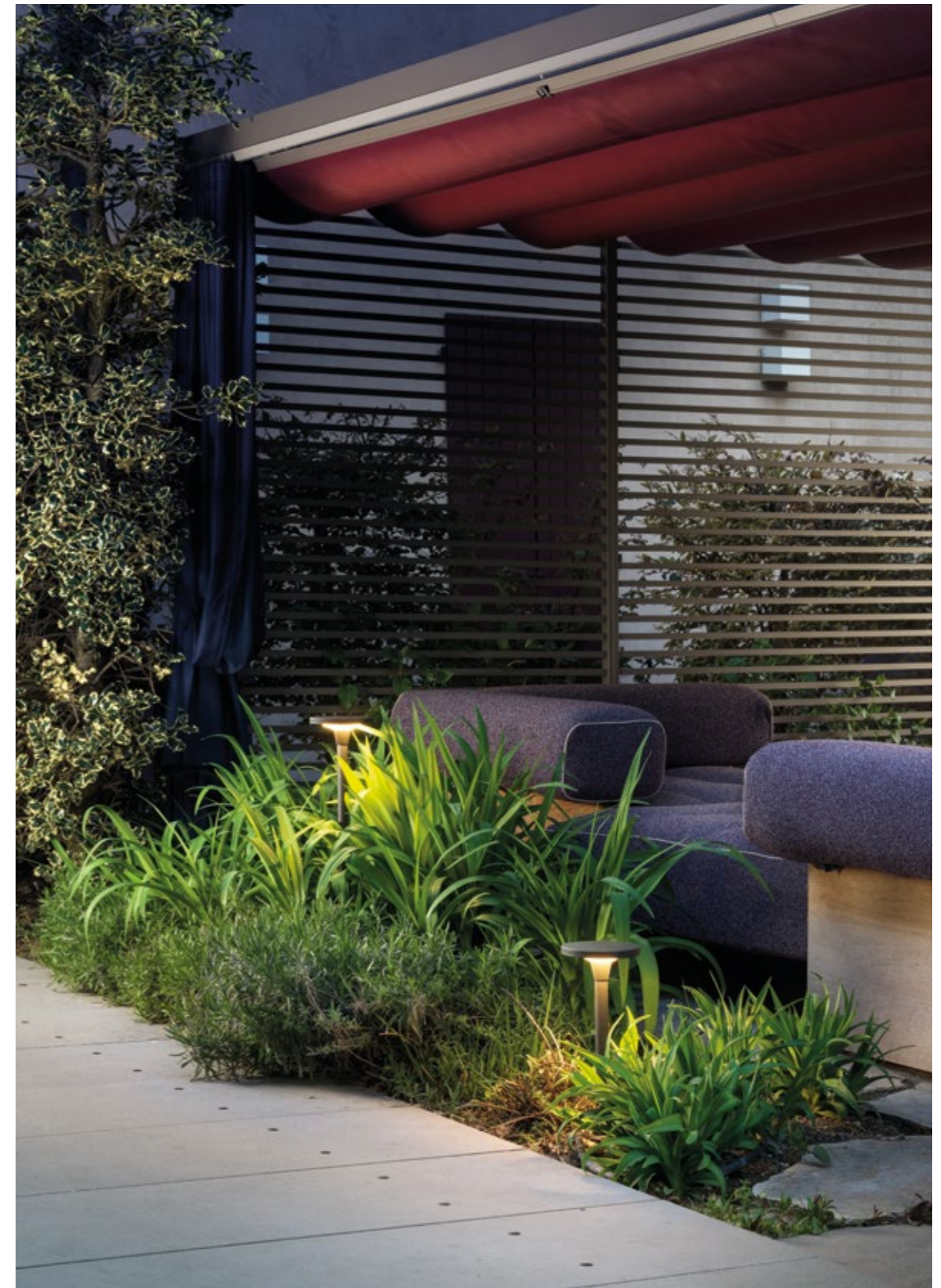

T-LUX STAN

Accessori / Accessories

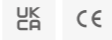

STELI / STEMS

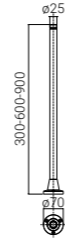
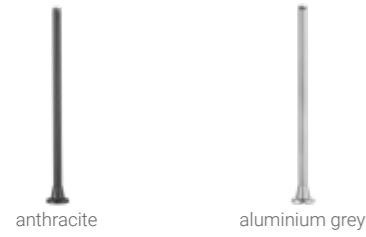

Code	H	Description	Ref to
3101	300 mm	Stelo in alluminio estruso, comprensivo di basetta in alluminio pressofuso / Stem in extruded aluminium with base in die-cast aluminium	code 5551
3102	600 mm		code 5551 code 5552
3103	900 mm		code 5552

Su richiesta / On request
 ● CO - corten ● VE - green

PICCHETTO / SPIKE

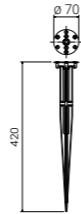

Code	Description	Ref. to
4696	Picchetto in policarbonato con piastra in acciaio inox AISI 304 / Spike in polycarbonate with plate in AISI 304 stainless steel	code 3101 code 3102

T-LUX STAN

Accessori / Accessories



PIASTRA TIRAFONDI / PLATE WITH ANCHORING SET

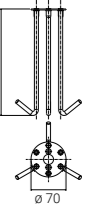

Code	Description	Ref. to
4697	Piastra in acciaio inox AISI 304 con tre tirafondi di ancoraggio / Plate in AISI 304 stainless steel with 3 ground anchors	code 3101 code 3102 code 3103

CASSAFORMA / IN-GROUND BOX

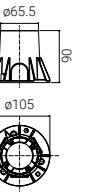

Code	Description	Ref. to
4698	Cassaforma per cablaggio interrato in tecnopolimero con anello in alluminio per fissaggio viti / In-ground box in technopolymer with aluminium ring to fix the screws	code 3101 code 3102 code 3103

Accessorio opzionale per cablaggio stagno / Optional accessory for waterproof wiring (code 1941)

T-LUX BOWLER

Cono in alluminio pressofuso a basso tenore di rame, la cui armoniosa forma racchiude il cablaggio e accompagna il flusso luminoso verso la parete.

Cone in die-cast aluminium with low copper content; its harmonious shape contains the wiring and guides the luminous flux towards the wall.



Disco dissipante in alluminio pressofuso a basso tenore di rame.

Dissipating **disc** in die-cast aluminium with low copper content.

Diffusore in policarbonato fotoinciso per prevenire l'abbagliamento laterale e garantire un effetto omogeneo con luce diffusa a 360°, grazie anche al diametro del modulo LED a tensione di rete che occupa interamente lo spazio interno dedicato.

Photo-etched polycarbonate **diffuser** to prevent side glare and to grant a homogeneous effect with 360° diffused light, thanks also to the diameter of the mains voltage LED module, that completely occupies the dedicated internal space.

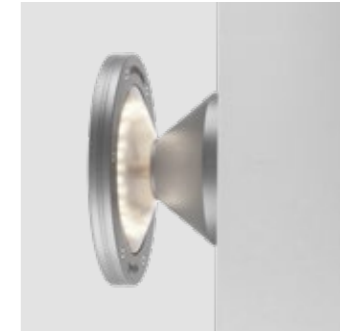
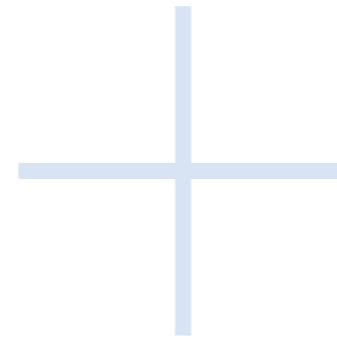

Hat trick

Il principio compositivo della sorgente luminosa celata ed evocativa è interpretato con BOWLER come effetto a parete, a completamento dell'atmosfera di luce d'ambiente che caratterizza la serie.

Hat trick

The compositional principle of the concealed and evocative light source is interpreted with BOWLER as a wall effect, completing the ambient light atmosphere that characterizes the series.

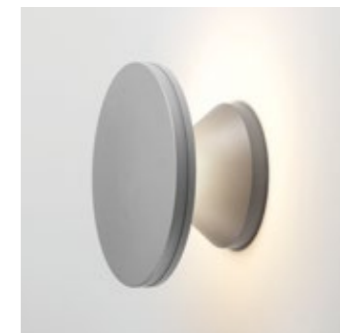

Punto - luce - effetto

La forma intuitiva della luce diventa un punto decorativo, o un motivo di punti, da disegnare suggestivamente con una scelta tra due diametri, 150 e 200 mm.

Point - light - effect

The intuitive shape of the light becomes a decorative point, or a motif of points, to be drawn suggestively with a choice between two diameters, 150 and 200 mm.

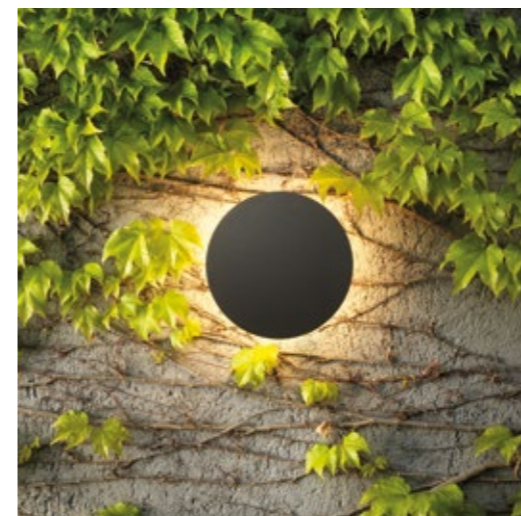

T-LUX BOWLER

Effetti a parete / Wall effects



T-LUX BOWLER Ø 150 mm

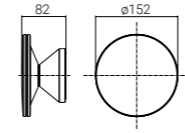

Code

5558		AN - anthracite	3K - 3000K
		AG - aluminium grey	4K - 4000K

Modulo LED a tensione di rete, compatibile con dimmer a taglio di fase /
Mains voltage LED module, compatible with most phase-cut dimmers
Compatibile con sagomatore / Compatible with beam limiter (code 5555)

Lamp	W	Lm LED	Real Lm	Optic
LED	10	1150	607	diffuse

Su richiesta / On request

2700K (code + **27K**)
24V low voltage (code + **24V**)
● CO - corten ○ BI - white

T-LUX BOWLER Ø 200 mm

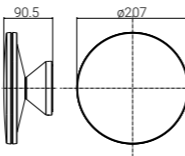

Code

5559		AN - anthracite	3K - 3000K
		AG - aluminium grey	4K - 4000K

Modulo LED a tensione di rete, compatibile con dimmer a taglio di fase /
Mains voltage LED module, compatible with most phase-cut dimmers

Lamp	W	Lm LED	Real Lm	Optic
LED	20	2300	1360	diffuse

Su richiesta / On request

2700K (code + **27K**)
24V low voltage (code + **24V**)
● CO - corten ○ BI - white



CANTHARELLUS



Un classico elemento luminoso rivisitato in chiave contemporanea. Progettato per illuminare verso il basso, CANTHARELLUS si presta eccellentemente per vialetti, percorsi e spazi intimi nei giardini. Grazie ai LED studiati nel disco superiore l'efficienza luminosa è alta e ben ottimizzata per entrambe le dimensioni disponibili. CANTHARELLUS si abbina alle tre altezze del palo Goccia Illuminazione o come lampada da montare con raccordo su palo Ø 60 mm.

A classic lighting element revisited in a contemporary way. Designed to illuminate downwards, CANTHARELLUS is particularly suitable for gardens, paths and intimate spaces outdoors. Thanks to the LEDs studied in the upper disc, the luminous efficiency is high and well optimized for both available sizes. CANTHARELLUS can be combined with the three heights of the Goccia Illuminazione pole or as a lamp to be mounted with an adaptor on a Ø 60 mm pole.

POLES



CANTHARELLUS
Ø 150



CANTHARELLUS
Ø 200

CANTHARELLUS

Coperchio convesso

La particolare forma del coperchio evita il ristagno dell'acqua.

Rounded cover

This profile avoids water stagnation.

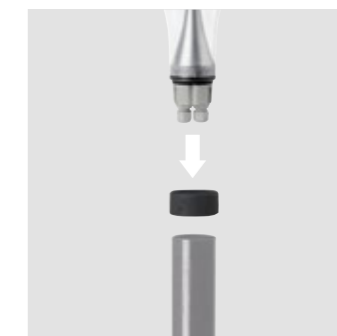
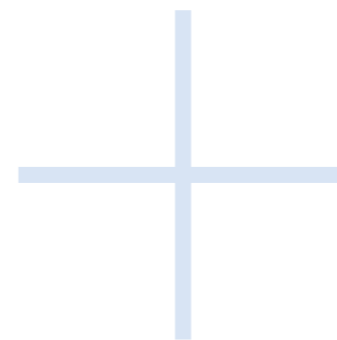

Adattatore per pali Ø 60 mm

Gli apparecchi CANTHARELLUS possono essere installati e fissati mediante uno speciale raccordo anche su qualsiasi palo di mercato di Ø 60 mm.

Adaptor for Ø 60 mm poles

CANTHARELLUS can be installed and fixed on any type of Ø 60 mm pole available on the market by a very simple adaptor.



Distribuzione della luce

Il posizionamento della scheda LED consente di direzionare la luce verso il basso, riducendo al minimo la dispersione verso l'alto.

Light distribution

The position of the LED module allows for directing the light downwards, minimising upward light dispersion.



Struttura

Parte superiore e scocca in lega di alluminio primario a basso tenore di rame. Coppa di protezione in policarbonato trasparente satinato. Cono interno in alluminio antiriflesso.

Structure

Upper part and body made of primary aluminium alloy with low copper content. Clear satin polycarbonate diffuser. Anti-glare aluminium internal cone.

Il corpo lampada è dotato di 2 pressacavi per consentire l'alimentazione passante.

The lamp body is provided with 2 cable glands for through wiring.

Pali in alluminio

Pali lisci in alluminio estruso. Disponibili in 3 altezze: 375, 800 e 1875 mm. CANTHARELLUS Ø 150 è consigliato per installazione sui pali di altezza 375 mm; CANTHARELLUS Ø 200 per pali da 800 o 1875 mm.

Aluminium poles

Extruded aluminium smooth poles. Three heights available: 375, 800 and 1875 mm. CANTHARELLUS Ø 150 version is recommended for 375 mm poles and the Ø 200 version for 800 or 1875 mm poles.

CANTHARELLUS

Pali da giardino / Garden poles



CORPO LAMPADA / LIGHT BODY Ø 150 mm

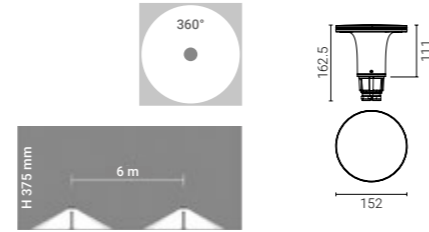

Code		
5521	● AN - anthracite	3K - 3000K 4K - 4000K

Modulo LED a tensione di rete, compatibile con dimmer a taglio di fase / Mains voltage LED module, compatible with most phase-cut dimmers

Lamp	W	Lm LED	Real Lm	Optic
LED	10	1150	863	diffuse

Su richiesta / On request

2700K (code + 27K)

24V low voltage (code + 24V)

● AG - aluminium grey ● CO - corten ● GR - graphite

CORPO LAMPADA / LIGHT BODY Ø 200 mm

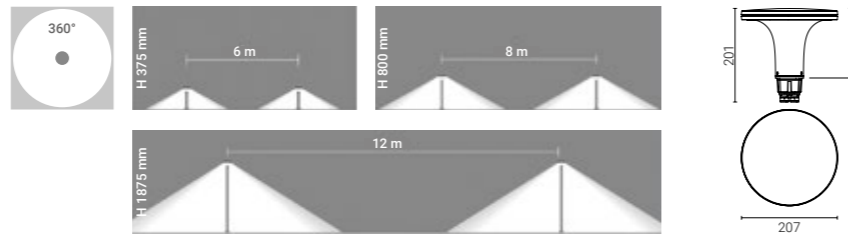

Code		
5522	● AN - anthracite	3K - 3000K 4K - 4000K

Modulo LED a tensione di rete, compatibile con dimmer a taglio di fase / Mains voltage LED module, compatible with most phase-cut dimmers

Lamp	W	Lm LED	Real Lm	Optic
LED	20	2300	1849	diffuse

Su richiesta / On request

2700K (code + 27K)

24V low voltage (code + 24V)

● AG - aluminium grey ● CO - corten ● GR - graphite

CANTHARELLUS

Accessori / Accessories



PALI / POLES



Code	
3421	● AN - anthracite
3422	
3423	

H	Description
375 mm	Palo liscio in alluminio estruso, comprensivo di base esterna in alluminio forgiato / Smooth pole in extruded aluminium with integrated external ground fixing base in forged aluminium
800 mm	
1875 mm	

Su richiesta / On request

● AG - aluminium grey ● CO - corten ● GR - graphite

PIASTRA TIRAFONDI / PLATE WITH ANCHORING SET

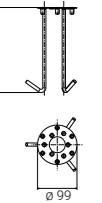

Code	Description
5519	Piastra inox con tirafondi per ancoraggio al terreno / Stainless steel plate with ground anchoring set

RACCORDO PER PALI STANDARD / ADAPTOR FOR STANDARD POLES Ø 60 mm



Code	Description
5506	Raccordo in alluminio primario pressofuso, adattabile a qualsiasi palo Ø 60 mm / Adaptor in die-cast primary aluminium, to be installed on any pole Ø 60 mm



CANTHUS



L'illuminazione cittadina di spazi aperti, come viali e parcheggi anche in un contesto privato, contribuisce alla loro vivibilità ed atmosfera - fondamentali risultano l'efficienza luminosa ed il comfort visivo.

Nata da un'intuizione per l'illuminazione residenziale, CANTHUS innalza l'eleganza, lo stile inconfondibile e la portata illuminante. Per esaltare la leggiadria delle forme nel contesto urbano, di un parco o della luce per grandi spazi, nel segno caratteristico della versatilità di installazione.

Un disegno di luce armonioso e forte.

Urban lighting of open spaces, such as avenues and parking lots, even in a private context, contributes to their livability and atmosphere - luminous efficiency and visual comfort are fundamental.

Inspired by an intuition for residential typologies, the new series CANTHUS raises the bar of elegance, unmistakable style and illuminating range. To exalt the elegance of shapes in an urban context, in a park, or lighting for large spaces, characterized by versatility of installation.

A harmonious and strong lighting design.

URBAN LIGHTING



CANTHUS

CANTHUS

Struttura

Corpo illuminante Ø 360 mm in alluminio pressofuso a basso tenore di rame. Diffusore in policarbonato anti UV e schermo lenticolare opalizzato. Palo Goccia Illuminazione Ø 76 mm in acciaio zincato a caldo, elettrosaldato, con codolo Ø 60 mm.

Structure

Ø 360 mm light fixture in low copper content die-cast aluminium. Anti UV polycarbonate diffuser and lenticular opal screen. Ø 76 mm Goccia Illuminazione pole in hot-dip galvanized steel, electro-welded, with Ø 60 mm top pole reduction.



Cablaggio

Cablaggio facilitato alla portella grazie al cavo 2x1 lungo 2,30 m; secondo ingresso M16 disponibile per cablaggio aggiuntivo.

Cabling

Easier cabling to cover panel thanks to the 2x1 cable, 2,30 m long; further pull down M16 entry for additional cabling.

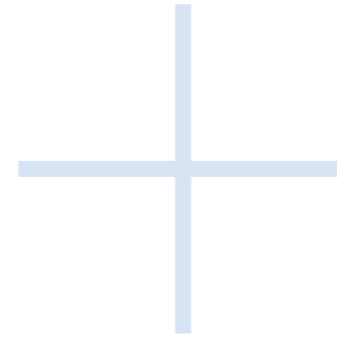

Perfetto accoppiamento

Armonica combinazione della testa CANTHUS con il palo Goccia Illuminazione Ø 76 mm (con codolo Ø 60 mm) nella stessa finitura.

Perfect coupling

Harmonious combination of CANTHUS top with Ø 76 mm Goccia Illuminazione pole (with Ø 60 mm top pole reduction) in the same finishing.



Schermo lenticolare

Appositamente progettato per garantire allo stesso tempo un elevato rendimento e il massimo comfort visivo.

Lenticular screen

Especially designed to grant at the same time high efficiency and maximum visual comfort.



Versatile adattabilità

Gli apparecchi CANTHUS possono essere installati su qualsiasi palo di mercato di Ø 60 mm.

Versatile adaptability

CANTHUS can be installed on any type of Ø 60 mm pole available on the market.

CANTHUS

Arredo urbano / Urban lighting



CORPI LAMPADA / LIGHT BODIES

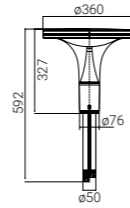

Code

5523	● AN - anthracite	3K - 3000K
5524		4K - 4000K

Lamp	W	Lm LED	Real Lm	Optic
LED	29	4400	2420	diffuse
	43	6400	3658	

Forniti con 2,30 m di cavo / 2,30 m cable included

Installabili a sormonto anche su pali standard Ø 60 mm in alluminio / To be mounted through overlapping installation also on standard Ø 60 mm aluminium poles

Eventuale protettore di sovratensioni da ordinare separatamente / Optional SPD to be ordered separately (page 327)

Su richiesta / On request

Versione dimmerabile / Dimmable version

● AG - aluminium grey

PALI / POLES

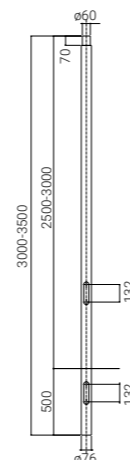

Code

H

Description

3504	● AN - anthracite	3000 mm (2500 mm fuori terra / above ground)	Palo liscio in acciaio Ø 76 mm ricavato da tubo elettrosaldato, zincato a caldo e verniciato. Completo di foro ingresso cavi, attacco di messa a terra e asola con portella e morsetti. Codolo superiore di installazione Ø 60 mm / Smooth pole Ø 76 mm in steel obtained from electro-welded tube, hot-dip galvanized and painted. Complete with cable entry, earthing connection and slot with door and terminal block. Top pole reduction Ø 60 mm
3505		3500 mm (3000 mm fuori terra / above ground)	

Eventuale protettore di sovratensioni installabile in portella (cod. 1966) da ordinare separatamente / Optional SPD installable inside the wiring box (code 1966) to be ordered separately



I-MAGO



Con il suo disegno unico e sapiente nelle proporzioni I-MAGO esalta la leggerezza e lo slancio delle forme accendendosi come una piccola cascata, una clessidra luminosa. L'esile stelo che si illumina in realtà supporta una scheda LED superiore capace di illuminare cospicuamente a terra in modo diretto, verso il basso, con un'apertura di diffusione di 120° e senza dispersione verso l'alto. Per inserirsi con discrezione ed eleganza nei giardini, presso i camminamenti, ai bordi degli spazi aperti, si compone con i pali in due diverse altezze in alluminio estruso o acciaio inossidabile.

With its unique design and skilful proportions, I-MAGO enhances the lightness and momentum of the shapes, lighting up like a small waterfall, a luminous hourglass. The slender stem that actually lights up supports an upper LED board capable of brightly illuminating the ground directly, downwards, with a diffusion angle of 120° and without upward dispersion. To fit with discretion and elegance in the gardens, near the walkways, at the edges of open spaces, it is composed with poles in two different heights in extruded aluminum or stainless steel.

POLES



I-MAGO



Struttura

Coppa in policarbonato trasparente stabilizzato anti UV. Parti interne in alluminio satinato. Corpo completo di scatola di cablaggio in tecnopolimero autoestinguente con anello di raccordo in alluminio verniciato o cromato.

Structure

Transparent polycarbonate UV resistant stabilised diffuser. Internal parts in satin aluminium. Body complete with self-extinguishing technopolymer wiring box with painted aluminium or chrome connection ring.

Il corpo lampada è dotato di 2 pressacavi per consentire l'alimentazione passante.

The lamp body is provided with 2 cable glands for through wiring.

Pali

- in **alluminio** estruso, a forma di poliedro stonato a 16 lati, completi di base in alluminio forgiato. Disponibili in due differenti altezze. La finitura grafite anti-UV garantisce la completa tenuta nel tempo
- in **acciaio inox AISI 316L**, spazzolati e lucidati, destinati a resistere nel tempo anche negli ambienti maggiormente esposti a corrosione. La sezione poligonale è un personale design ottenuto da trafilatura

Poles

- in **extruded aluminium** with 16 rounded sides profile and base in forged aluminium. Available in two different heights. The finish graphite makes I-LUX not invasive and ideal to be installed everywhere in the garden
- in **AISI 316L stainless steel**, brushed and polished, made to resist to the most corrosive environments. The original polygonal profile enhances the pole

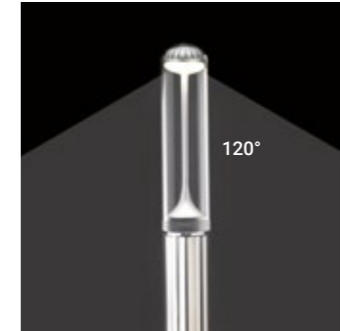
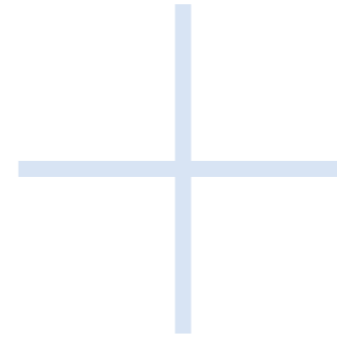

Piccola cascata di luce

La luce dei 4 LED di potenza è orientata verso il basso con un angolo di diffusione di 120°.

Small waterfall of light

The light from the 4 power LEDs is directed downwards with an angle of diffusion of 120°.

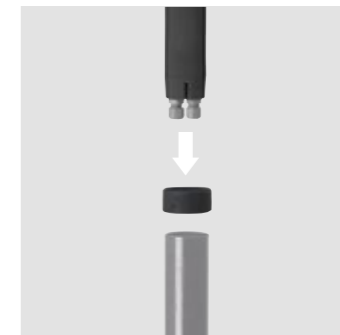

Adattatore per pali Ø 60 mm

Gli apparecchi I-MAGO possono essere installati mediante uno speciale raccordo anche su qualsiasi palo di mercato di Ø 60 mm.

Adaptor for Ø 60 mm poles

I-MAGO can be installed on any type of Ø 60 mm pole available on the market by a very simple adaptor.



I-MAGO

Pali da giardino / Garden poles



CORPI LAMPADA / LIGHT BODIES



aluminium



AISI 316L st. steel

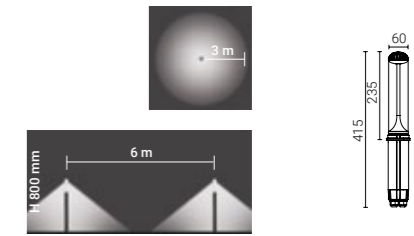

	Code	
5510	● GR - graphite	3K - 3000K
		4K - 4000K
5500	● IN - stainless steel	

Material	Lamp	W	Lm LED	Real Lm	Optic
aluminium	LED	7,5	750	380	diffuse
AISI 316L st. steel					

Su richiesta / On request
10÷52V low voltage (code + LV)

PALI / POLES



codes 3501 3502 GR



codes 3511 3512 IN



	Code	
3501	● GR - graphite	
3502		
3511	● IN - stainless steel	
3512		

H	Description
375 mm	Palo in alluminio estruso e base in alluminio forgiato / Pole in extruded aluminium and base in forged aluminium
800 mm	
375 mm	Palo e base in acciaio inox AISI 316L, interamente spazzolato e lucidato / Pole and base in AISI 316L stainless steel, brushed and polished
800 mm	

I-MAGO

Accessori / Accessories



PICCHETTO / SPIKE



Code	Description
5505	Picchetto da giardino in tecnopolimero, listelli laterali di bloccaggio incorporati / Garden spike in technopolymer, side blocking bars incorporated

PIASTRA TIRAFONDI / PLATE WITH ANCHORING SET

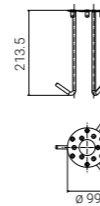

Code	Description
5519	Piastra inox con tirafondi per ancoraggio al terreno / Stainless steel plate with ground anchoring set

RACCORDO PER PALI STANDARD / ADAPTOR FOR STANDARD POLES Ø 60 mm

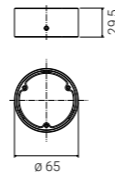

Code	Description
5506	Raccordo in alluminio primario pressofuso, adattabile a qualsiasi palo Ø 60 mm / Adaptor in die-cast primary aluminium, to be installed on any pole Ø 60 mm



I-LUX



I-LUX di Goccia Illuminazione è una lampada da giardino stilizzata ed elegante che si inserisce perfettamente negli ambienti più raffinati. Realizzata per ospitare sorgenti luminose LED oppure lampade a risparmio energetico, è proposta nella versione trasparente con frangiluce interno direzionabile, oppure opale, per diffondere uniformemente la luce. Il sistema I-LUX consente l'abbinamento delle lampade con i pali standard Ø 60, ma si completa con i pali scanalati in alluminio e acciaio inox AISI 316L, o con i bracci a muro dedicati per l'installazione a parete.

I-LUX by Goccia Illuminazione is a stylized and elegant garden lamp that fits perfectly into the most refined environments. Designed to house LED light sources or energy-saving lamps, it is proposed in the transparent version with internal directional louvre, or in the opal version, to spread the light evenly. The I-LUX system allows the lamps to be combined with standard Ø 60 poles, but is completed with grooved poles in aluminum and AISI 316L stainless steel, or with dedicated wall arms for wall installation.

POLES



I-LUX

Struttura

Coppa in policarbonato opale o trasparente stabilizzato anti UV. Corpo completo di scatola di cablaggio in tecnopolimero autoestinguente con anello di raccordo in alluminio o cromato.

Structure

Opal or transparent polycarbonate UV resistant stabilised diffuser. Body complete with self-extinguishing technopolymer wiring box with aluminium or chrome connection ring.

Il corpo lampada è dotato di 2 pressacavi per consentire l'alimentazione passante.

The lamp body is provided with 2 cable glands for through wiring.



Pali

- in **alluminio** estruso, a forma di poliedro stondato a 16 lati, completi di base in alluminio forgiato. Disponibili in due differenti altezze. La finitura grafite anti-UV garantisce la completa tenuta nel tempo
- in **acciaio inox AISI 316L**, spazzolati e lucidati, destinati a resistere nel tempo anche negli ambienti maggiormente esposti a corrosione. La sezione poligonale è un personale design ottenuto da trafilatura

Poles

- in **extruded aluminium** with 16 rounded sides profile and base in forged aluminium. Available in two different heights. The finish graphite makes I-LUX not invasive and ideal to be installed everywhere in the garden
- in **AISI 316L stainless steel**, brushed and polished, made to resist to the most corrosive environments. The original polygonal profile enhances the pole

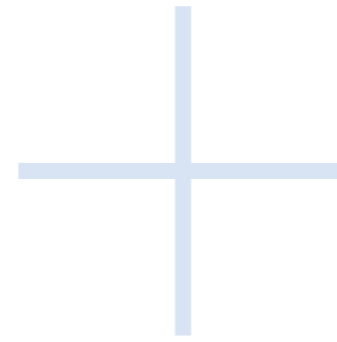

Frangiluce orientabile con leva esterna

Il frangiluce interno è orientabile tramite leva esterna e consente di schermare la luce evitando l'abbagliamento.

Adjustable anti-dazzling reflector

The internal louvre can be adjusted using the outer lever to shield light to prevent glare.

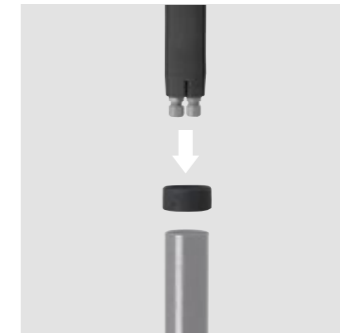

Adattatore per pali Ø 60 mm

Gli apparecchi I-LUX possono essere installati mediante uno speciale raccordo anche su qualsiasi palo di mercato di Ø 60 mm.

Adaptor for Ø 60 mm poles

I-LUX can be installed on any type of Ø 60 mm pole available on the market by a very simple adaptor.



CORPI LAMPADA OPALI / OPAL LIGHT BODIES

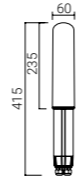

Code			Material	Lamp	W	Lm LED	Real Lm	Optic
5517	● GR - graphite	3K - 3000K	aluminium	LED G23	9	930	600	diffuse
		4K - 4000K		G23	11	-	-	
5501		-						
5540	● IN - stainless steel	3K - 3000K	AISI 316L st. steel	LED G23	9	930	600	
		4K - 4000K		G23	11	-	-	
5503		-						

Coppa opale / Opal diffuser
 5517, 5540 Forniti con lampadina LED / Supplied with LED lamp
 5501, 5503 Forniti senza lampadina / Supplied without lamp

CORPI LAMPADA TRASPARENTI CON FRANGILUCE / TRANSPARENT LIGHT BODIES WITH LOUVRE

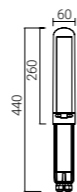

Code			Material	Lamp	W	Lm LED	Real Lm	Optic
5502	● GR - graphite	-	aluminium	G23	11	-	-	diffuse
5504		● IN - stainless steel	AISI 316L st. steel					

Coppa trasparente e frangiluce orientabile / Clear diffuser + antidazzling adjustable reflector
 Forniti senza lampadina / Supplied without lamp



PALI / POLES



codes 3501 3502 GR



codes 3511 3512 IN

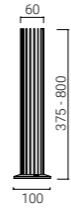

Code		H	Description
3501	● GR - graphite	375 mm	Palo in alluminio estruso e base in alluminio forgiato / Pole in extruded aluminium and base in forged aluminium
3502		800 mm	
3511	● IN - stainless steel	375 mm	Palo e base in acciaio inox AISI 316L, interamente spazzolato e lucidato / Pole and base in AISI 316L stainless steel, brushed and polished
3512		800 mm	

BRACCI / ARMS



code 5511 GR



code 5512 IN

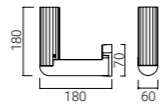

code 5511

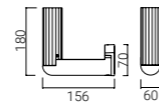

code 5512



code 5515 GR



code 5516 IN

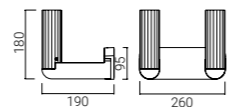

code 5515

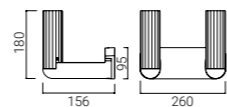

code 5516

Code		Description
5511	● GR - graphite	Braccio a muro singolo in alluminio / Single wall-arm in aluminium
5515		Braccio a muro doppio in alluminio / Double wall-arm in aluminium
5512	● IN - stainless steel	Braccio a muro singolo in inox AISI 316L / Single wall-arm in AISI 316L stainless steel
5516		Braccio a muro doppio in inox AISI 316L / Double wall-arm in AISI 316L stainless steel

PICCHETTO / SPIKE



Code	Description
5505	Picchetto da giardino in tecnopolimero, listelli laterali di bloccaggio incorporati / Garden spike in technopolymer, side blocking bars incorporated

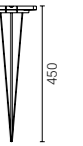

PIASTRA TIRAFONDI / PLATE WITH ANCHORING SET



Code	Description
5519	Piastra inox con tirafondi per ancoraggio al terreno / Stainless steel plate with ground anchoring set

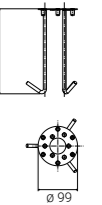

RACCORDO PER PALI STANDARD / ADAPTOR FOR STANDARD POLES Ø 60 mm



Code	Description
5506	Raccordo in alluminio primario pressofuso, adattabile a qualsiasi palo Ø 60 mm / Adaptor in die-cast primary aluminium, to be installed on any pole Ø 60 mm



I-DEA



L'atmosfera raffinata e soffusa dell'abat-jour diventa l'ispirazione per I-DEA, la lampada per esterni che porta questa sensazione accogliente nei giardini e negli spazi all'aperto. Un fusto esile e robusto supporta il paralume in policarbonato colorato, leggero ma con resistenza antivandalo, con i diversi colori accesi per caratterizzare l'ambiente. I-DEA è disponibile in due altezze differenti oppure per pali standard Ø 60, nelle sue versioni LED o a risparmio energetico. Nelle sua variante in vetro lavorato I-DEA PREZIOSA esalta la morbidezza della forma e della diffusione della luce, con i suoi delicati riflessi in un gioco di alternanza di chiaroscuri irripetibile, in tre diverse colorazioni.

The refined and suffused atmosphere of the abat-jour becomes the inspiration for I-DEA, the outdoor lamp that brings this welcoming feeling to gardens and outdoor spaces. A slim and sturdy frame supports the colored polycarbonate lampshade, light but with vandal-proof resistance, with the different bright colors to characterize the environment. I-DEA is available in two different heights or for standard Ø 60 poles, in its LED or energy saving versions. With the model in crafted glass, I-DEA PREZIOSA enhances the softness of shape and diffusion of light, with its delicate reflections in an alternating game of unrepeatable chiaroscuro, in three different colors.

POLES



I-DEA



I-DEA
PREZIOSA



Il corpo lampada è dotato di 2 pressacavi per consentire l'alimentazione passante.

The lamp body is provided with 2 cable glands for through wiring.

Pali

Pali in alluminio estruso con piede in alluminio forgiato.

Poles

Poles in extruded aluminium with forged aluminium base.

Struttura

Il testa-palo è composto da due elementi:

- **paraluce** in policarbonato o in vetro lavorato a mano con paraluce interno bianco riflettente
- **corpo lampada** con raggiera in alluminio pressofuso, completo di scatola di cablaggio in tecnopolimero autoestinguente

Structure

The pole head is composed by two parts:

- polycarbonate or hand-crafted glass **lampshade**. White internal lampshade for maximum downward light reflection
- **light body** with aluminium die-cast spokes, complete with self-extinguishing technopolymer wiring box

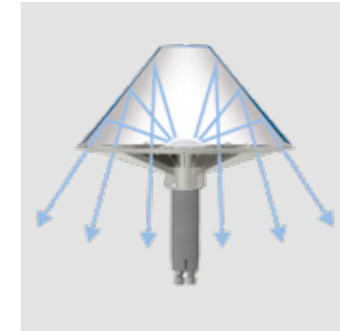
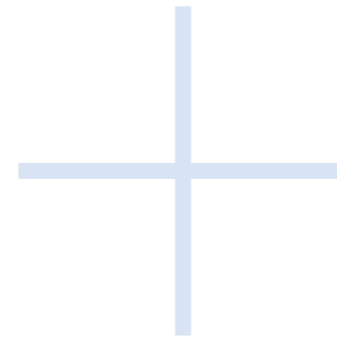

Luce verso il basso

Paraluce con interno riflettente per irraggiare la luce verso il basso.

Downward light

Lampshade with reflective inside to radiate light downwards.

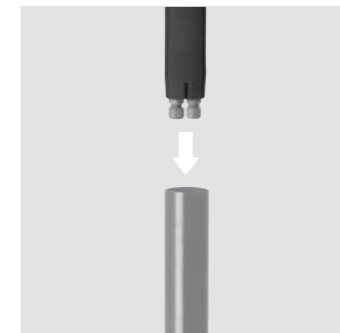

Versatile adattabilità

Gli apparecchi I-DEA possono essere installati su qualsiasi palo di mercato di Ø 60 mm.

Versatile adaptability

I-DEA can be installed on any type of Ø 60 mm pole available on the market.



I-DEA

Pali da giardino / Garden poles



CORPI LAMPADA / LIGHT BODIES

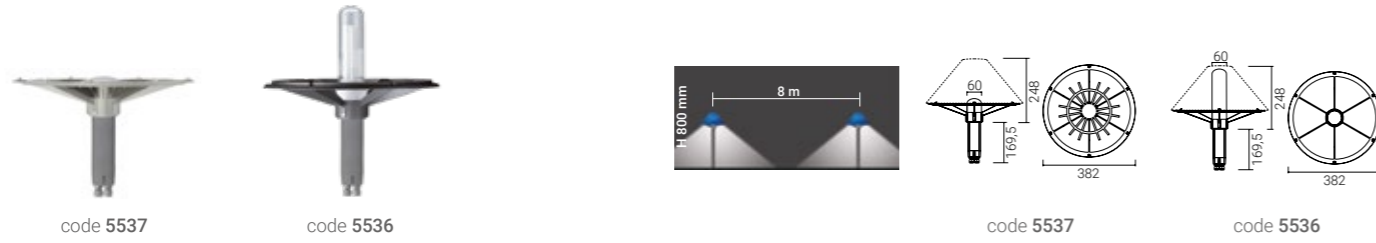

Code	Lamp	W	Lm LED	Real Lm	Optic	Class
5537	LED	10	1100	521	diffuse	I
5536	E27	33 max	-	-		II

Modulo LED a tensione di rete, compatibile con dimmer a taglio di fase / Mains voltage LED module, compatible with most phase-cut dimmers
E27 Ø max 50 mm (fornito senza lampadina / supplied without lamp)

Su richiesta / On request
2700K (code + 27K)

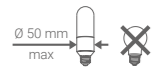

PARALUCI / LAMPSHADES



Code	Description
5531	Paraluce in policarbonato anti UV / Polycarbonate lampshade, UV resistant
5534	Paraluce in vetro lavorato con paraluce interno in policarbonato bianco / Crafted glass lampshade with internal lampshade in white polycarbonate

I-DEA

Accessori / Accessories



PALI / POLES



Code	H	Description
3501	375 mm	Palo in alluminio estruso e base in alluminio forgiato / Post in extruded aluminium and base in forged aluminium
3502	800 mm	

PICCHETTO / SPIKE



Code	Description
5505	Picchetto da giardino in tecnopolimero, listelli laterali di bloccaggio incorporati / Garden spike in technopolymer, side blocking bars incorporated

PIASTRA TIRAFONDI / PLATE WITH ANCHORING SET

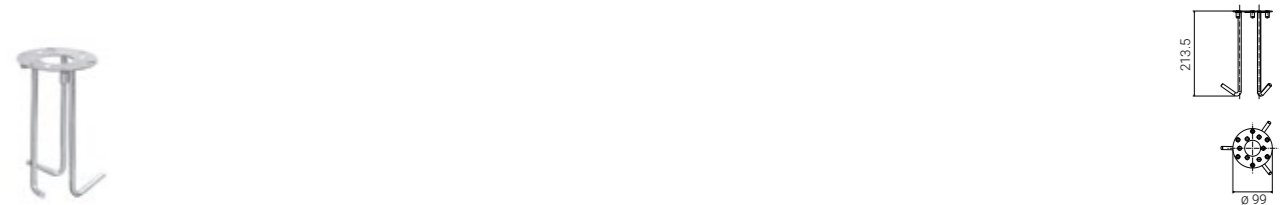

Code	Description
5519	Piastra inox con tirafondi per ancoraggio al terreno / Stainless steel plate with ground anchoring set

WASH



Con geometria essenziale e raffinatezza dei dettagli WASH offre un'illuminazione wall washer precisa e di effetto.

Le diverse dimensioni e le moderne forme squadrate o curve per l'installazione a parete consentono configurazioni con luce verso il basso, verso l'alto o in entrambe le direzioni. Il vetro a filo scocca del diffusore intensifica l'effetto luminoso del LED ad alta efficienza: opale, con luce morbida diffusa; trasparente ultrawhite, con luce diretta ed incisiva, con la possibilità di indirizzare il flusso luminoso verso la parete o verso l'esterno. Le diverse finiture proposte incontrano i diversi stili di inserimento ed esaltano la finezza delle linee.

With essential geometry and refinement of details, WASH offers precise and effective wall washer lighting.

The different sizes and modern square or curved shapes for wall installation allow configurations with light downwards, upwards or in both directions.

The glass diffuser flush with the body intensifies the lighting effect of the high-efficiency LED: opal, with soft diffused illumination; ultrawhite transparent, with direct and incisive lighting, with the possibility of directing the luminous flux towards the wall or towards the outside. The different finishes proposed meet the different styles of insertion and enhance the refinement of the lines.

WALL EFFECTS



WASH 22
opal



WASH 22
asymmetric



WASH 42
opal



WASH 24
opal

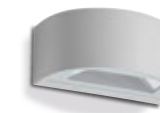

WASH 24
asymmetric



WASH 52
opal

WASH

Struttura

Diffusore a filo in vetro temprato, opale o trasparente ultrawhite. Corpo in alluminio pressofuso in lega marina a basso tenore di rame.

Structure

Opal or ultrawhite clear tempered flush glass diffuser. Low copper content marine die-cast aluminium body.



Disponibile con doppia luce contrapposta e luce singola orientabile verso l'alto o verso il basso.

Available with double or single light that can be adjusted upwards or downwards.

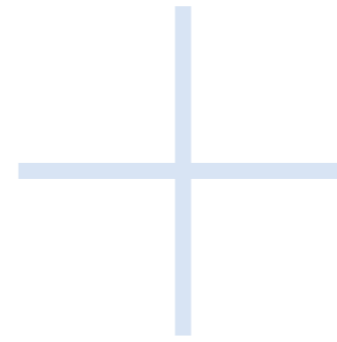

Ottiche e vetri

Versione con modulo lineare LED e vetro opale per una luce diffusa e morbida. Versione LED COB con parabola asimmetrica riposizionabile e vetro trasparente ultrawhite per una luce diretta, nitida ed incisiva.

Optics and glass

Version with LED linear module and opal glass for a soft and comfortable light. Version with COB LED, adjustable asymmetric reflectors and ultrawhite clear glass for a direct, sharp and incisive light.



Riposizionamento semplicissimo

La versione con vetri trasparenti è fornita con una o due parabole asimmetriche che possono essere individualmente riposizionate per orientare la luce verso la parete, accentuando l'effetto wall-washer, o verso l'esterno per illuminare i camminamenti.

La variazione della posizione delle parabole è semplice, agevole e può essere effettuata anche ad apparecchio installato. Sollevare la parabola e ruotarla di 180°, poi riposizionarla nella sua sede.

Simple reflector adjustment

The asymmetric reflector can be individually fixed in two different positions: towards the wall to highlight the wall-washer effect or adjusted outwards to illuminate balconies, walkways, corridors, etc.

It is quite simple to adjust the reflector: adjustment can be made even if the light is on. Unscrew, lift the reflector, turn 180° and screw.

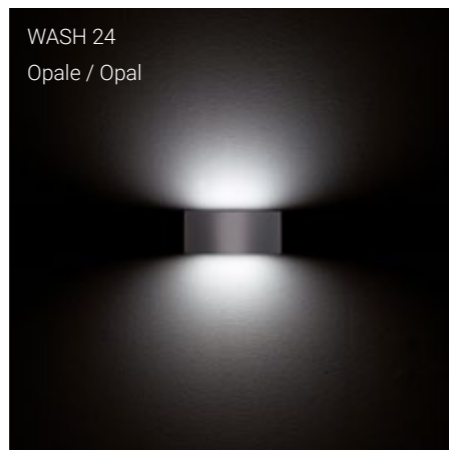
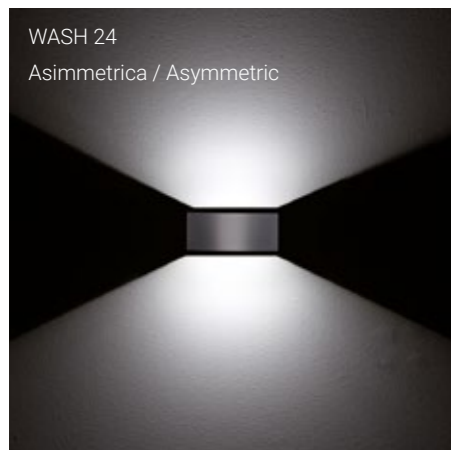
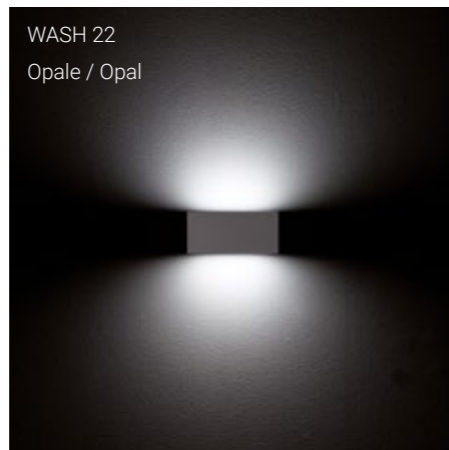
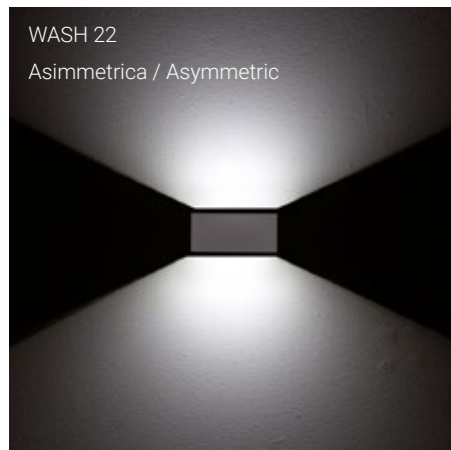

WASH

Effetti a parete / Wall effects



WASH 22 OPAL

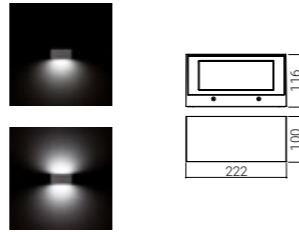

Code

Code	Color	Temp
1305	AN - anthracite	3K - 3000K 4K - 4000K
1301	AG - aluminium grey	
1306	BI - white	
1302	CO - corten	

1305, 1301 Modulo lineare LED / Linear LED module
E27 L max 176 mm (fornite senza lampadina / supplied without lamp)

Lamp	W	Lm LED	Real Lm	Optic
LED	1x9	1120	674	1 x diffuse
	2x9	2240	1348	2 x diffuse
E27	18	-	-	1 x diffuse
				2 x diffuse

Su richiesta / On request
2700K (code + **27K**)
1305, 1301 Versione dimmerabile / Dimmable version
1305, 1301 Versione emergenza / Emergency version
● GR - graphite ● GM - metallized grey

WASH

Effetti a parete / Wall effects



WASH 24 OPAL

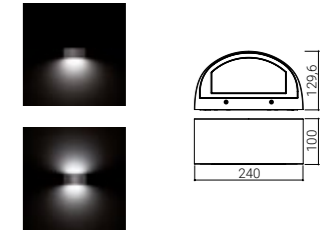

Code

Code	Color	Temp
1324	AN - anthracite	3K - 3000K 4K - 4000K
1321	AG - aluminium grey	
1325	BI - white	
1322	CO - corten	

1324, 1321 Modulo lineare LED / Linear LED module
E27 L max 176 mm (fornite senza lampadina / supplied without lamp)

Lamp	W	Lm LED	Real Lm	Optic
LED	1x9	1120	674	1 x diffuse
	2x9	2240	1348	2 x diffuse
E27	18	-	-	1 x diffuse
				2 x diffuse

Su richiesta / On request
2700K (code + **27K**)
1324, 1321 Versione dimmerabile / Dimmable version
1324, 1321 Versione emergenza / Emergency version
● GR - graphite ● GM - metallized grey

WASH 22 ASYMMETRIC

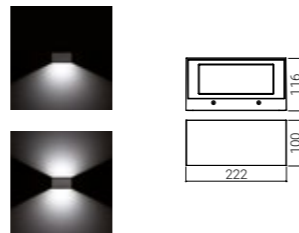

Code

Code	Color	Temp
1309	AN - anthracite	3K - 3000K 4K - 4000K
	AG - aluminium grey	
	BI - white	
1308	CO - corten	

Vetro trasparente con parabola asimmetrica e LED COB /
Ultra-white clear glass + asymmetric reflector + COB LED

Lamp	W	Lm LED	Real Lm	Optic
LED	1x11	1405	1150	1 x asym.
	2x11	2810	2300	2 x asym.

Su richiesta / On request
2700K (code + **27K**)
● GR - graphite ● GM - metallized grey

WASH 24 ASYMMETRIC

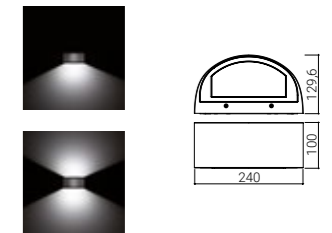
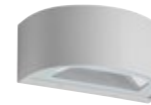

Code

Code	Color	Temp
1328	AN - anthracite	3K - 3000K 4K - 4000K
	AG - aluminium grey	
	BI - white	
1327	CO - corten	

Vetro trasparente con parabola asimmetrica e LED COB /
Ultra-white clear glass + asymmetric reflector + COB LED

Lamp	W	Lm LED	Real Lm	Optic
LED	1x11	1405	1150	1 x asym.
	2x11	2810	2300	2 x asym.

Su richiesta / On request
2700K (code + **27K**)
● GR - graphite ● GM - metallized grey

WASH

Effetti a parete / Wall effects



WASH 42 OPAL

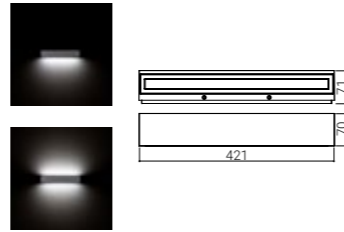

Code	
1312	<ul style="list-style-type: none"> AN - anthracite AG - aluminium grey
	3K - 3000K 4K - 4000K
1311	<ul style="list-style-type: none"> BI - white CO - corten

Lamp	W	Lm LED	Real Lm	Optic
LED	1x13	1629	977	1 x diffuse
	2x13	3258	1954	2 x diffuse

Modulo lineare LED / Linear LED module

Su richiesta / On request

2700K (code + **27K**)
 Versione dimmerabile / Dimmable version
 Versione emergenza / Emergency version
 GR - graphite GM - metallized grey

WASH 52 OPAL

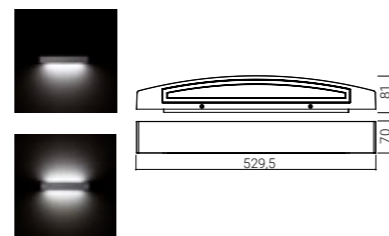

Code	
1333	<ul style="list-style-type: none"> AN - anthracite AG - aluminium grey
	3K - 3000K 4K - 4000K
1332	<ul style="list-style-type: none"> BI - white CO - corten

Lamp	W	Lm LED	Real Lm	Optic
LED	1x13	1629	977	1 x diffuse
	2x13	3258	1954	2 x diffuse

Modulo lineare LED / Linear LED module

Su richiesta / On request

2700K (code + **27K**)
 Versione dimmerabile / Dimmable version
 Versione emergenza / Emergency version
 GR - graphite GM - metallized grey



K³



La forma elementare del cubo K³ veste un'idea innovativa: disegnare con la luce. Potenze e ottiche specifiche per l'illuminazione di effetto a parete in mono-, bi- e quadriemissione. La costruzione in alluminio, in tre colori, o in acciaio inox AISI 316L si completa con vetri a filo cornice, garantendo un isolamento in Classe II e tenuta IP65.

K³ MINILED, grazie alle dimensioni contenute, si inserisce elegantemente in spazi coperti o interni. All'esterno può sprigionare la sua potenza e definizione per creare effetti vivaci o per illuminare puntualmente i dettagli.

K³ WRITER è lo strumento creativo illuminotecnico. Con la combinazione di lenti, sagomatori e filtri colorati enfatizza l'architettura di una facciata o porta un gioco di luce nuovo e originale.

K³ POWER racchiude la massima potenza luminosa della serie. Grazie ad un accurato studio ottico delle parabole garantisce un rendimento luminoso molto elevato, per un'illuminazione in esterno di grande impatto e portata. Con i versatili accessori si arricchisce di orientabilità ed illuminazione di superficie.

The elementary shape of the K³ cube contains an innovative idea: drawing with light. Specific powers and optics for single-, double- and four-emission wall effect lighting. The construction in aluminum, in three colors, or in AISI 316L stainless steel is completed with glass flush with the frame, guaranteeing Class II insulation and IP65 rating.

K³ MINILED, thanks to its small size, fits elegantly into covered or indoor spaces. Outdoors it can unleash its power and definition to create lively effects or to punctually illuminate details.

K³ WRITER is the creative lighting tool. With the combination of lenses, profiles and colored filters, it emphasizes the architecture of a facade or brings a new and original play of light.

K³ POWER contains the maximum luminous power of the series. Thanks to an accurate optical study of the parabolas, it guarantees a very high light output, for outdoor lighting of great impact and range. With the versatile accessories it is enriched with adjustability and surface lighting.

WALL EFFECTS

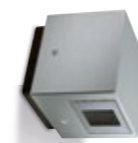

K³ MINILED
1 window

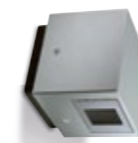

K³ MINILED
2 windows



K³ MINILED
4 windows



K³ WRITER
1 window



K³ WRITER
2 windows



K³ WRITER
4 windows



K³ POWER
1 window



K³ POWER
2 windows



K³ POWER
4 windows

K³ MINILED

Struttura

I diffusori in policarbonato sono a filo cornice onde evitare ristagni d'acqua.
Corpo in alluminio pressofuso a basso tenore di rame o in acciaio inox AISI 316L.
Viti inox a brugola in tinta.
Ingresso cavi dal retro.

Structure

The polycarbonate diffusers at frame level avoid stagnant water on the upper surface. Low copper content die-cast aluminium or AISI 316L stainless steel body. Matching stainless steel Allen screws. Rear cable entry.



Gli apparecchi sono disponibili in alluminio e in acciaio inox AISI 316L.

The lighting fittings are available in primary aluminium and in AISI 316L stainless steel.

Fasci luminosi

K³ MINILED è composta da 3 apparecchi:

- cubo con una finestra
- cubo con due finestre contrapposte
- cubo con quattro finestre

Il fascio luminoso è disponibile in due diverse angolazioni:

- stretto 30°
- diffuso 70°

Beam angles

K³ MINILED range consists of 3 fixtures:

- cube with one window
- cube with two opposite windows
- cube with 4 windows

Two beam angles available:

- narrow 30°
- wide 70°

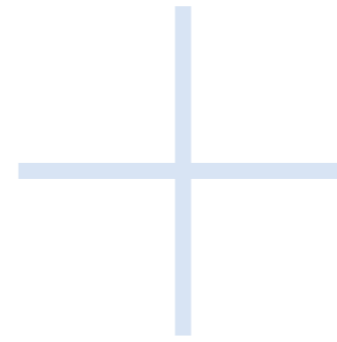
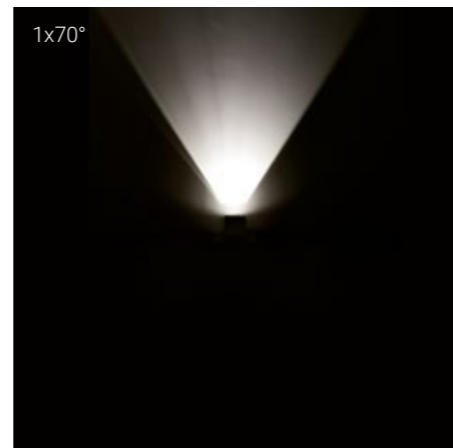
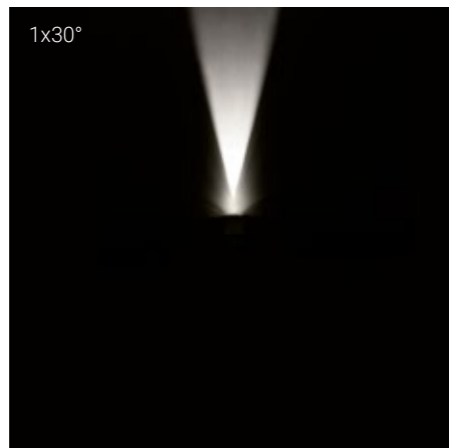

Geometria della luce

La sorgente è orientata verso la parete per accentuare un nitido effetto geometrico. I sagomatori interni 30° e 70° permettono svariate combinazioni di luce.

Geometry of the light

The LED source is directed toward the wall to accentuate a definite geometric effect. The 30° and 70° shapers allow different light combinations.

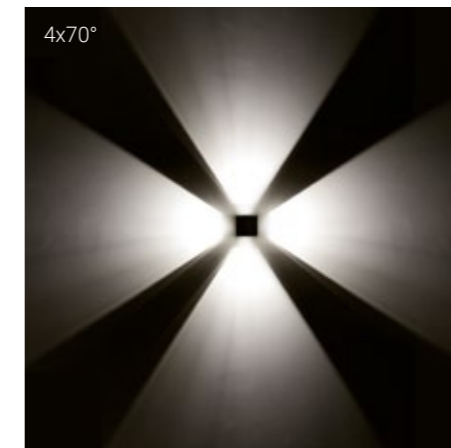
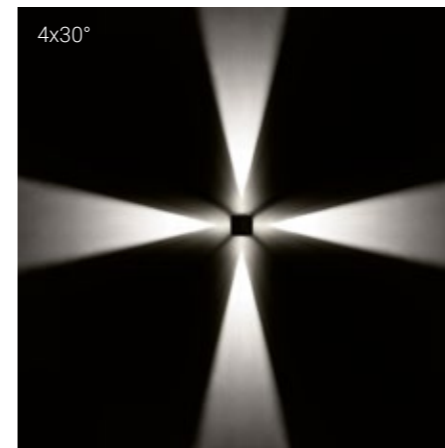
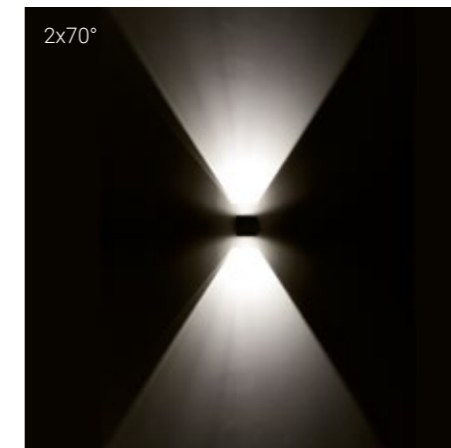
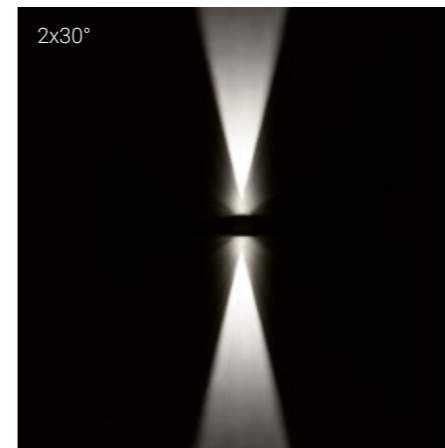

LAMPADE / LUMINAIRES



aluminium 1 window AISI 316L st. steel 1 window

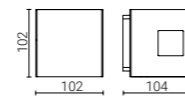
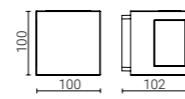

aluminium 2 windows AISI 316L st. steel 2 windows

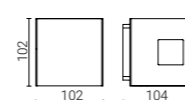
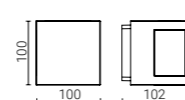
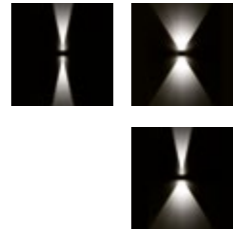

aluminium 4 windows AISI 316L st. steel 4 windows

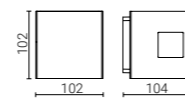
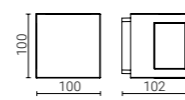
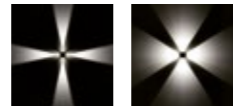

Code	Material	Color
1040	aluminium	● AN - anthracite
1041		
1042		
1043		
1044		
1045		● BI - white
1046		
1050		
1051		
1052		
1053	AISI 316L stainless steel	● IN - stainless steel
1054		
1055		
1056		

Material	Lamp	W	Lm LED	Real Lm	Optic
aluminium	LED	1x3	300	36	1x30°
				200	1x70°
		2x3	600	72	2x30°
				400	2x70°
		4x3	1200	236	30°+70°
				144	4x30°
AISI 316L stainless steel	LED	1x3	300	800	4x70°
				36	1x30°
		2x3	600	200	1x70°
				72	2x30°
		4x3	1200	400	2x70°
				236	30°+70°
4x3	1200	144	4x30°		
		800	4x70°		

Su richiesta / On request

2700K (code + 27K)

Ottica / Optic 15° (code + 15)

1040, 1041, 1042, 1043, 1044, 1045, 1046

● CO - corten ● GR - graphite ● GM - metallized grey

PICCHETTO / SPIKE

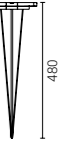

Code

1090

Description

Picchetto da giardino in tecnopolimero / Garden spike in technopolymer



K³ WRITER

Struttura

Diffusore in vetro temprato ultrawhite e corpo in alluminio pressofuso a basso tenore di rame o in acciaio inox AISI 316L. Viti inox a brugola in tinta. Interno interamente nero opaco per evitare fastidiose riflessioni luminose. Ingresso cavi dal retro.

Structure

Ultrawhite transparent tempered glass diffuser and low copper content die-cast aluminium or AISI 316L stainless steel body. Matching stainless steel Allen screws. Completely matt black inside to avoid any unwanted flare. Rear cable entry.

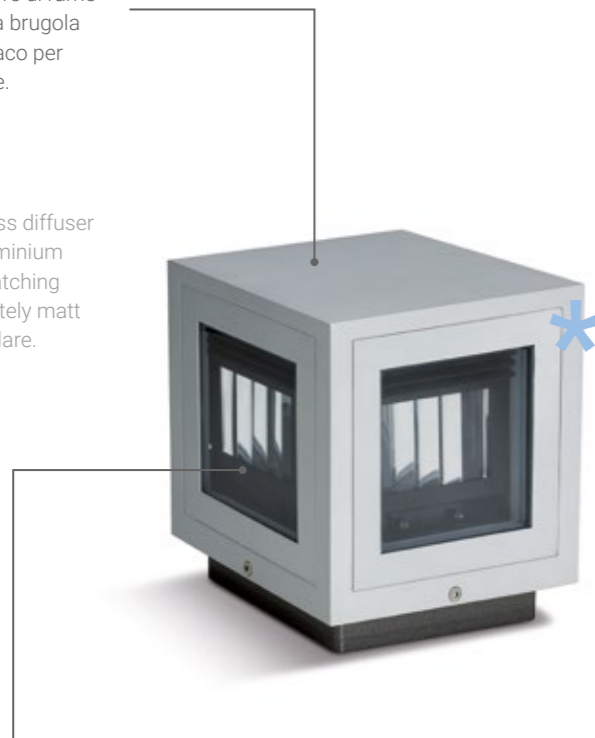

Gli apparecchi sono disponibili in alluminio e in acciaio inox AISI 316L.

The lighting fittings are available in primary aluminium and in AISI 316L stainless steel.

Infinite combinazioni

Inserendo i 4 accessori si ottengono infinite combinazioni:

- due lenti concentratrici in vetro a 1 o 5 lame, progettate per ottenere effetti di alta intensità
- due schermi sagomati
- quattro filtri cromatici permettono di arricchire gli effetti luminosi con il colore

Infinite combinations

The 4 accessories permit infinity combinations:

- two converging lenses in borosilicate glass for 1 or 5 blades designed to enhance its lighting effects
- two shapers
- four dichroic color filters

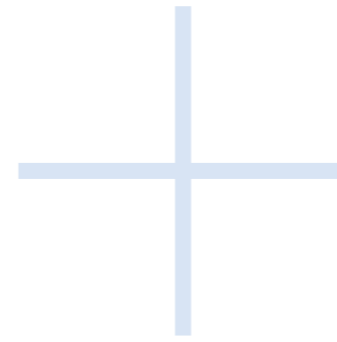
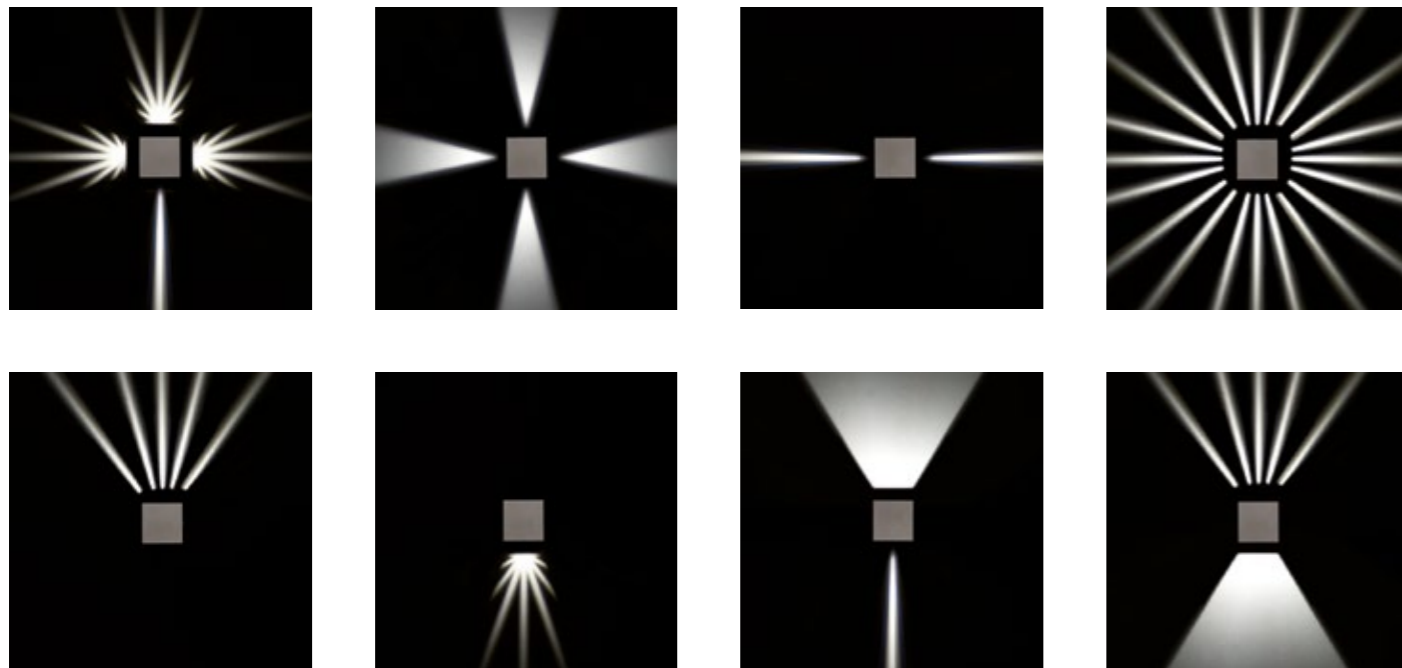

Centraggio della focale

L'installazione delle lenti e dei sagomatori è semplicissima: le 4 viti su asola consentono il centraggio dell'accessorio e della sua focale.

Centring focus

Lens and shapers can be easily inserted: 4 screws and its oval slots permit a complete and perfect focus regulation.



Smontaggio semplificato

Lo smontaggio è semplificato ed è agevole anche con l'apparecchio installato, consentendo un successivo inserimento degli accessori in dotazione. L'interno è studiato per garantire la massima efficienza luminosa e il perfetto puntamento della luce.

Easy disassembly

Assembling and maintenance are simple even if the fixture is already installed, allowing at any time to insert the accessories of the range. The inside has been studied to ensure maximum lighting efficiency and perfect light effects.

K³ WRITER

Effetti a parete / Wall effects



LAMPADE / LUMINAIRES



aluminium 1 window AISI 316L st. steel 1 window



aluminium 2 windows AISI 316L st. steel 2 windows



aluminium 4 windows AISI 316L st. steel 4 windows

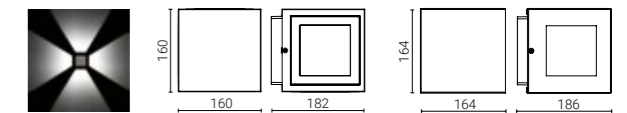
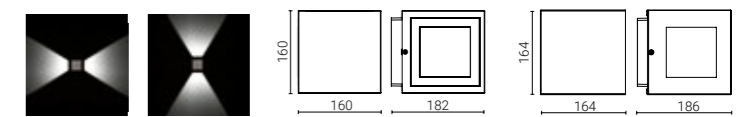
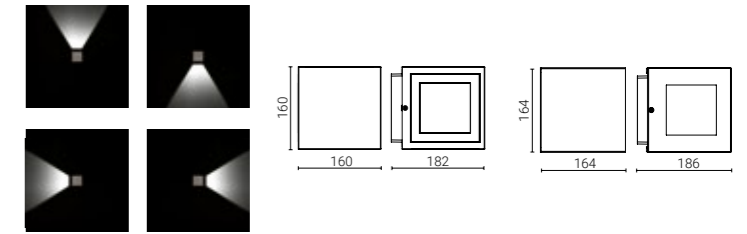

Code		
1004	● AN - anthracite	3K - 3000K 4K - 4000K
1008	● AG - aluminium grey	
1022	○ BI - white	
1014		
1018	● IN - stainless steel	
1033		

1014, 1018, 1033 Struttura esterna in inox AISI 316L, parte interna in alluminio / AISI 316L stainless steel external structure, die-cast primary aluminium inside

Material	Lamp	W	Lm LED	Real Lm	Optic
aluminium	LED	1x6,4	640	168	1x70°
		2x6,4	1280	336	2x70°
		4x6,4	2560	672	4x70°
AISI 316L stainless steel		1x6,4	640	168	1x70°
		2x6,4	1280	336	2x70°
		4x6,4	2560	672	4x70°

Su richiesta / On request

Versione dimmerabile / Dimmable version

1022 Versione a 3 aperture / 3 windows version (code + 3F)

1004, 1008, 1022 ● GR - graphite ● GM - metallized grey

LENTI / LENSES

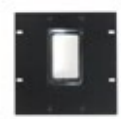

code 1091

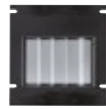

code 1092

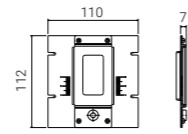

code 1091

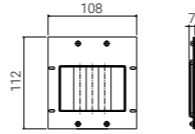

code 1092

Code	Description
1091	Lente convergente a 1 lama in vetro borosilicato purissimo, asole per centraggio della focale / Converging 1 blade lens in pure borosilicate glass, lateral slots for focus regulation
1092	Lente convergente a 5 lame in vetro borosilicato purissimo, asole per centraggio della focale / Converging 5 blades lens in pure borosilicate glass, lateral slots for focus regulation

FILTRI COLORATI / DICHOIC FILTERS

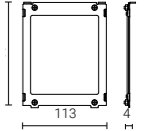

Code	Description
1096	Filtro colore con trattamento dicroico, vetro in borosilicato e telaio in acciaio nero / Dichroic finish, color and glass amalgam system and black steel frame

1 filtro per 1 faccia / 1 filter for 1 window

SAGOMATORI / SHAPERS



code 1093



code 1095

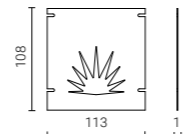

code 1093

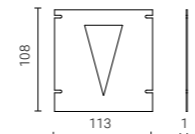

code 1095

Code	Description
1093	Sagomatore a foglia in acciaio / Steel leaf shaper
1095	Sagomatore 30° in acciaio / Steel 30° shaper



Gli apparecchi sono disponibili in alluminio e in acciaio inox AISI 316L.

The lighting fittings are available in primary aluminium and in AISI 316L stainless steel.

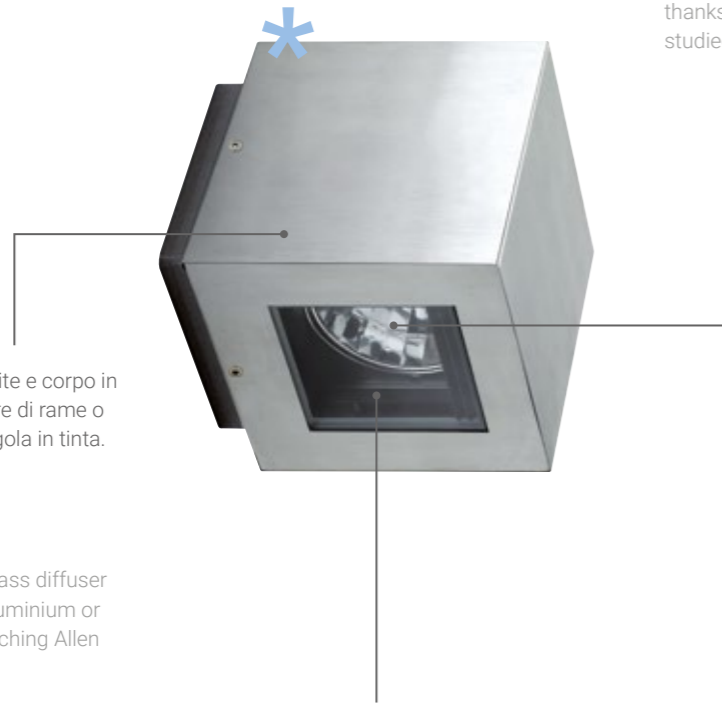

Struttura

Diffusore in vetro temprato ultrawhite e corpo in alluminio pressofuso a basso tenore di rame o in acciaio inox AISI 316L. Viti a brugola in tinta. Ingresso cavi dal retro.

Structure

Ultrawhite transparent tempered glass diffuser and low copper content die-cast aluminium or AISI 316L stainless steel body. Matching Allen screws. Rear cable entry.

Efficienza luminosa

L'efficienza luminosa è assicurata da riflettori illuminotecnici in alluminio brillantato 99,8, appositamente progettati per ottimizzare la diffusione della luce.

Lighting efficiency

The lighting efficiency is extremely high, thanks to parabolic Al 99,8 reflectors studied specifically for LED source.

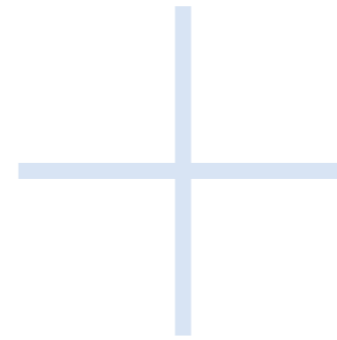

Elevate prestazioni

Il dissipatore alettato dedicato consente superiori wattaggi. Mediante l'utilizzo della staffa snodo orientabile K³ POWER diventa uno spot di potenza.

High performances

The dedicated louvered heat sink allows higher wattages. Thanks to the orientable articulated bracket K³ POWER becomes a high performing spot.



Fasci luminosi

K³ POWER è composta da 3 apparecchi:

- cubo con una finestra
- cubo con due finestre contrapposte
- cubo con quattro finestre

Il fascio luminoso è disponibile in due diverse angolazioni:

- stretto 20°
- diffuso 50°

Beam angles

K³ POWER range consists of 3 fixtures:

- cube with one window
- cube with two opposite windows
- cube with 4 windows

Two beam angles available:

- narrow 20°
- wide 50°

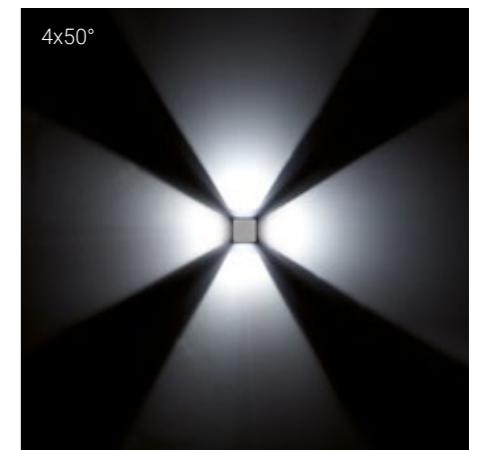
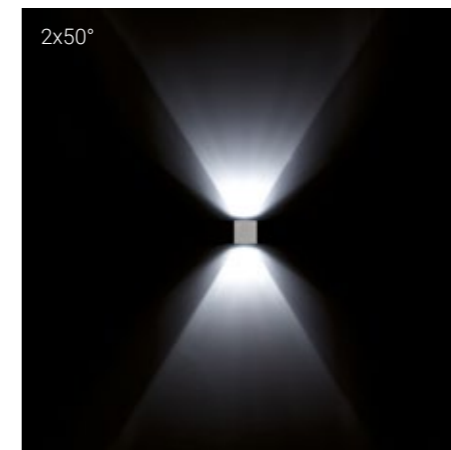
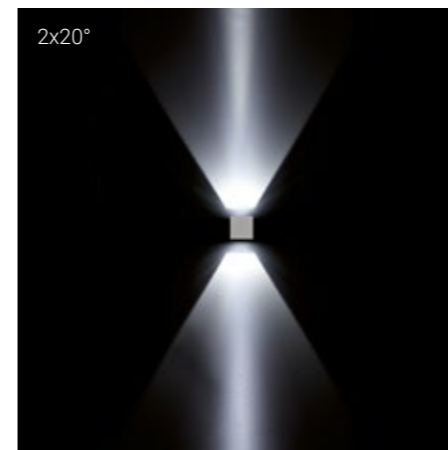
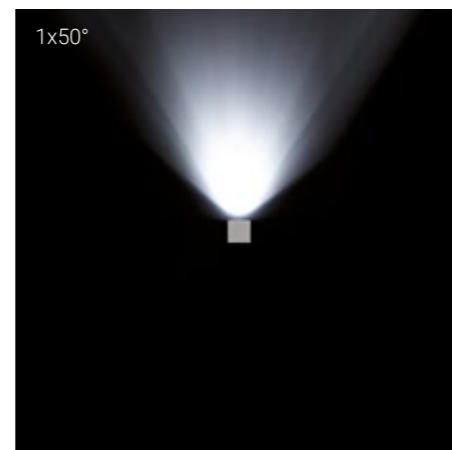
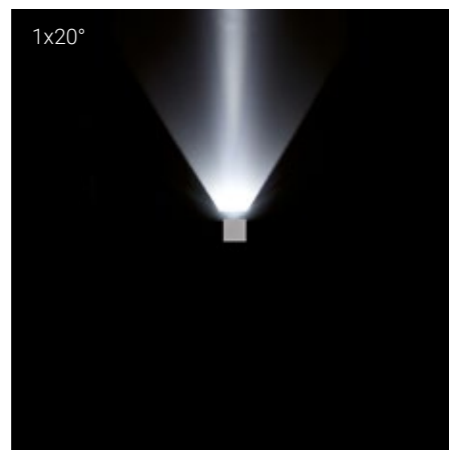

LAMPADE / LUMINAIRES

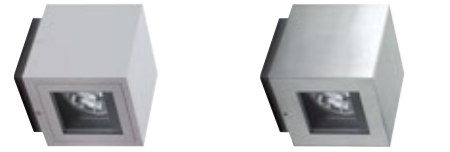

aluminium 1 window AISI 316L st. steel 1 window



aluminium 2 windows AISI 316L st. steel 2 windows



aluminium 4 windows AISI 316L st. steel 4 windows

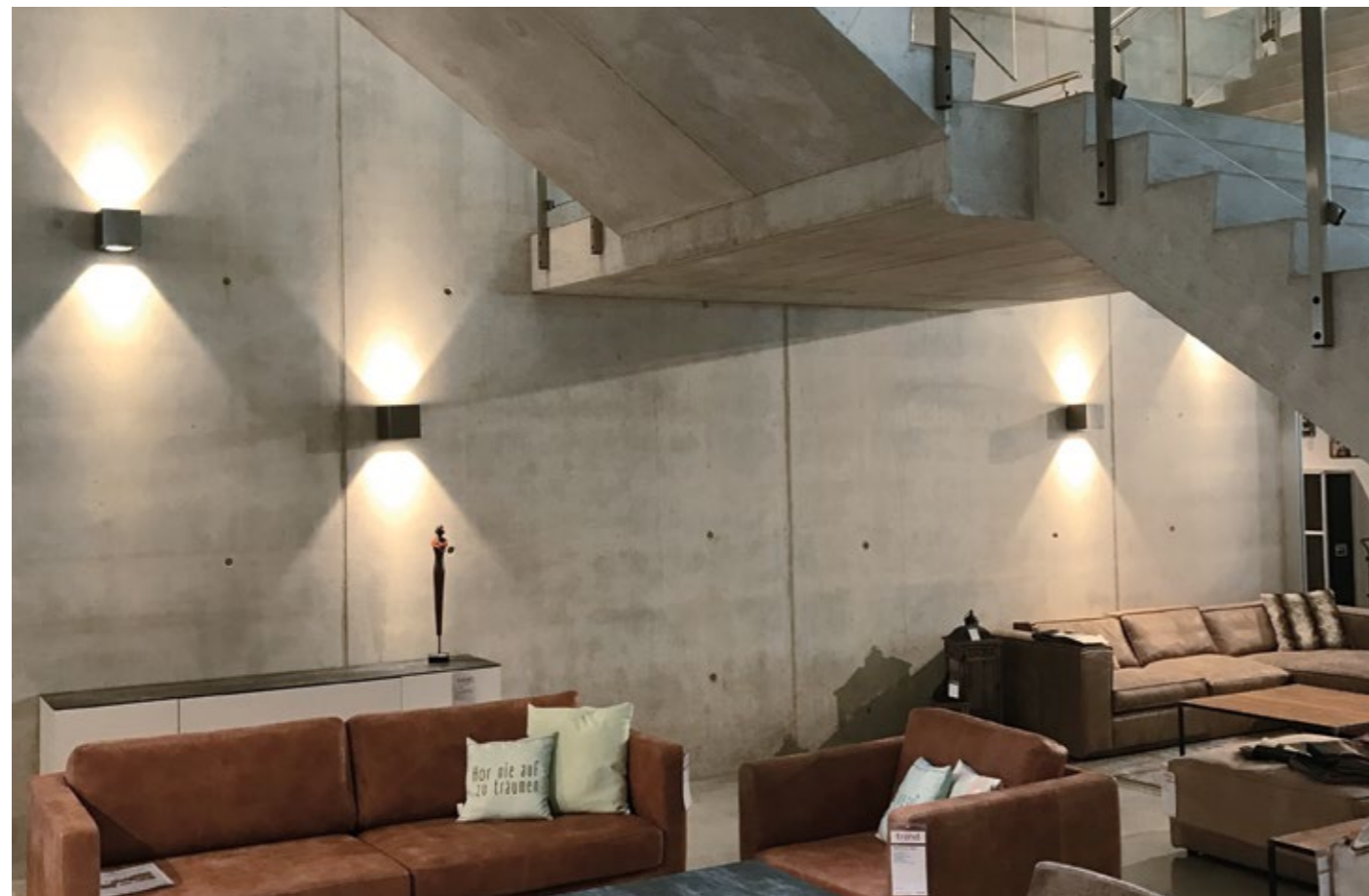
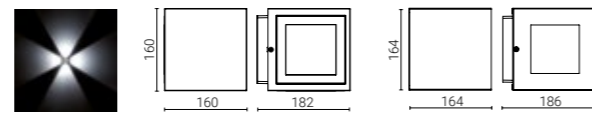
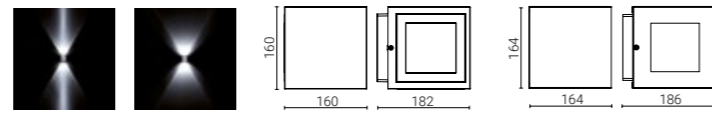
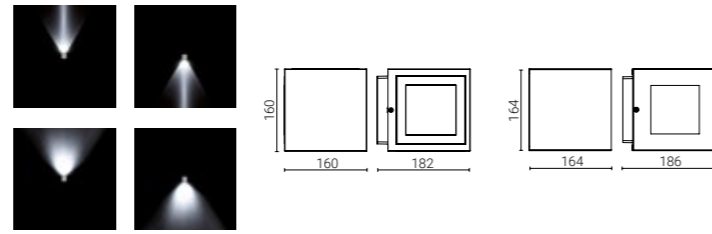

Code		Material	Lamp	W	Lm LED	Real Lm	Optic	
1102	3K - 3000K 4K - 4000K	aluminium	LED	1x11	1405	1060	1x20°	
1141				1x18	2761	1900		
1105				1x11	1405	927	1x50°	
1142				1x18	2761	1690		
1106	-		E27	75	-	-		
1109	3K - 3000K 4K - 4000K		aluminium	LED	2x11	2810	2120	2x20°
1146					2x18	5522	3800	
1122					2x11	2810	1854	2x50°
1147		2x18			5522	3380		
1123	-	E27		75	-	-	4x50°	
1128	-							
1112	3K - 3000K 4K - 4000K	AISI 316L stainless steel		LED	1x11	1405	1060	1x20°
1151					1x18	2761	1900	
1115			1x11		1405	927	1x50°	
1152			1x18		2761	1690		
1116	-		E27	75	-	-		
1119	3K - 3000K 4K - 4000K		AISI 316L stainless steel	LED	2x11	2810	2120	2x20°
1156					2x18	5522	3800	
1132					2x11	2810	1854	2x50°
1157		2x18			5522	3380		
1133	-	E27		75	-	-	4x50°	
1138	-							

Versione RGBW (vedi capitolo dedicato) / RGBW version (see dedicated chapter)
E27 L max 128 mm (fornite senza lampadina / supplied without lamp)

Su richiesta / On request

2700K (code + 27K)

Versione dimmerabile / Dimmable version

1102, 1141, 1105, 1142, 1106, 1109, 1146, 1122, 1147, 1123, 1128

● GR - graphite ● GM - metallized grey

STAFFA A SNODO / ARTICULATED BRACKET

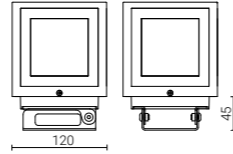

Code	Description
1191	Staffa a snodo, rotazione max 90° / Articulated bracket, max rotation 90°

PICCHETTO / SPIKE

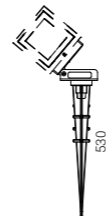

Code	Description
1192	Picchetto da giardino in tecnopolimero con staffa a snodo max 90° / Garden spike in technopolymer with articulated bracket max 90°

PIASTRA CON TIRAFONDI / PLATE WITH ANCHORING SET

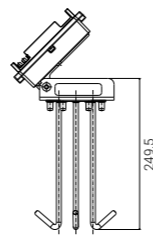

Code	Description
1193	Piastra inox da interrare con tirafondi e staffa a snodo max 90° / Stainless steel plate with anchoring set and articulated bracket max 90°

GRIGLIA ANTIABBAGLIANTE / ANTI-GLARE FLANGED LOUVRE

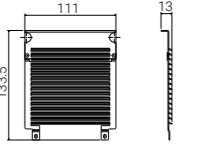

Code	Description
1194	Griglia in ferro antiabbagliante / Anti-glare flanged louvre

Da installare internamente / To be installed inside



APPARECCHI DA
PARETE O SOFFITTO

WALL OR CEILING
FITTINGS

SMALL, MIDI, MAXI & SUPERMAXI



Questa serie di lampade dal design essenziale è impostata su una sezione triangolare in alluminio estruso, completata con cornice in alluminio pressofuso e tappi laterali in policarbonato. Si articola in quattro modelli con diverse lunghezze.

Le versioni SMALL, MIDI e MAXI sono proposte con diffusore in vetro ultrawhite con l'opzione griglia antiabbagliante, con lampade a basso consumo o LED ad alta efficienza. La versione SUPERMAXI nelle tre lunghezze, in Classe II, monta performanti sorgenti LED ed è stata accuratamente sviluppata con i suoi accessori per le applicazioni lineari in fila continua ed alternata. Una soluzione di grande efficacia negli spazi esterni, pubblici e privati, sviluppati in lunghezza, che si completa con le funzionalità Corridor per il risparmio energetico con i sensori di rilevamento di presenza.

This series of lamps with an essential design is set on a triangular section in extruded aluminum, completed with a die-cast aluminum frame and polycarbonate side caps. It is divided into four models with different lengths. The SMALL, MIDI and MAXI versions are offered with an ultrawhite glass diffuser with an anti-glare guard option, with low-consumption lamps or high-efficiency LEDs. The SUPERMAXI version in the three lengths, in Class II, is equipped with high-performance LED sources and has been carefully developed with its accessories for linear applications in continuous and alternating lines. A highly effective solution in outdoor spaces, public and private, developed in length, which is completed with the Corridor functions for energy saving with PIR sensors.

WALL OR CEILING FITTINGS



SMALL



MIDI



MAXI



SUPERMAXI

SMALL, MIDI, MAXI & SUPERMAXI



Diffusore

Diffusore opale in vetro temprato ultrawhite per SMALL, MIDI e MAXI; in policarbonato anti UV per SUPERMAXI. Il diffusore in policarbonato opale consente la distribuzione uniforme della luce.

Diffuser

Opal ultrawhite tempered glass diffuser for SMALL, MIDI and MAXI; opal UV resistant polycarbonate diffuser for SUPERMAXI. The polycarbonate diffuser emanates a wide and uniform light diffusion.



Griglia in alluminio

La griglia in alluminio pressofuso con diffusore in vetro temperato, disponibile per le serie SMALL, MIDI e MAXI, è un efficace filtro antiabbagliante, senza compromettere la portata luminosa.

Aluminium guard

The die-cast aluminium guard, available for SMALL, MIDI and MAXI, is an efficient antidazzling filter, maintaining anyway the complete light emission.



SUPERMAXI "Corridor"

La funzione Corridor consente di eliminare automaticamente l'illuminazione inutile, grazie al circuito con rilevatore di presenza. 10% in stato di quiete con accensione automatica al 100% al passaggio.

SUPERMAXI "Corridor"

The Corridor function automatically eliminates non-useful illumination thanks to a PIR sensor circuit. 10% at rest mode and 100% upon detection.

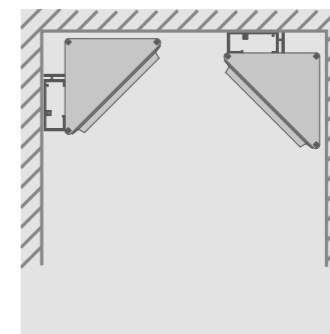
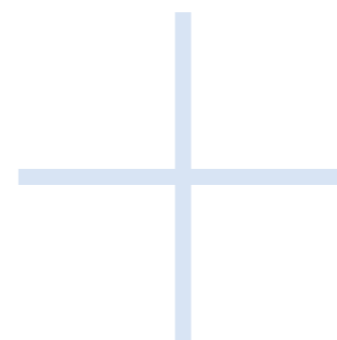

Installazione a parete e a soffitto

Con il sistema di installazione a canale è possibile posizionare le lampade a parete o a soffitto, anche ad angolo.

Wall and ceiling installation

Channel installation makes it possible to position lamps on walls or ceilings, including in corners.



Installazione a canale

Il canale di 3,2 m consente di installare facilmente linee di lampade SUPERMAXI. Due staffette permettono di agganciarle al canale con un semplice gesto consentendo il posizionamento di precisione e il perfetto allineamento.

Channel installation

The 3,2 m channel allows for easy installation of SUPERMAXI lamp lines. Two brackets allows you to easily attach the channel, permitting precision positioning and perfect alignment.

SMALL

Da parete o soffitto / Wall or ceiling



IK 08

SMALL

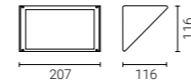

Code			Lamp	W	Lm LED	Real Lm	Optic	Class
5608	● NE - black	3K - 3000K 4K - 4000K	LED	8,5	850	419	diffuse	II
5606	● AG - aluminium grey	-	E 27	60	-	-	-	I

Diffusore opale in vetro temprato ultrawhite / Opal diffuser in ultra-white glass
E 27 L max 130 mm (fornita senza lampadina / supplied without lamp)

Su richiesta / On request
5608 24V low voltage (code + **24V**)

SMALL CON GRIGLIA / WITH GUARD

IK 10

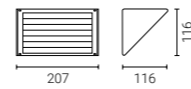

Code			Lamp	W	Lm LED	Real Lm	Optic	Class
5607	● NE - black	-	E 27	60	-	-	-	I
	● AG - aluminium grey	-						

Diffusore opale in vetro temprato ultrawhite / Opal diffuser in ultra-white glass
E 27 L max 130 mm (fornita senza lampadina / supplied without lamp)

MIDI

Da parete o soffitto / Wall or ceiling



IK 08

MIDI

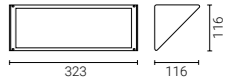

Code			Lamp	W	Lm LED	Real Lm	Optic	Class
5621	● NE - black	3K - 3000K 4K - 4000K	LED	17	1700	838	diffuse	II
5618	● AG - aluminium grey	-	2G11	18	-	-	-	I
5626			G24q-3	26	-	-	-	I

Diffusore opale in vetro temprato ultrawhite / Opal diffuser in ultra-white glass
5618, 5626 Fornite senza lampadina / Supplied without lamp

Su richiesta / On request
Diffusore in policarbonato antivandalo / Vandalproof polycarbonate diffuser
(code + **PC**)
5621 24V low voltage (code + **24V**)

MIDI CON GRIGLIA / WITH GUARD

IK 10

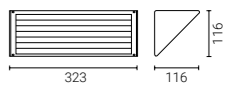

Code			Lamp	W	Lm LED	Real Lm	Optic	Class
5619	● NE - black	-	2G11	18	-	-	-	I
5627	● AG - aluminium grey	-	G24q-3	26	-	-	-	I

Diffusore opale in vetro temprato ultrawhite / Opal diffuser in ultra-white glass
Fornite senza lampadina / Supplied without lamp

Su richiesta / On request
Diffusore in policarbonato antivandalo / Vandalproof polycarbonate diffuser
(code + **PC**)

MAXI

Da parete o soffitto / Wall or ceiling



MAXI

IK 08

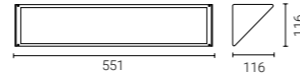

Code	Lamp	W	Lm LED	Real Lm	Optic	Class
5638	LED		3400	1677	diffuse	II
4450	LED 3h emergency	34	3400/500	1677/247		I
5636	2G11	36	-	-		
5652	G24q-3	2x26	-	-		

Diffusore opale in vetro temprato ultrawhite / Opal diffuser in ultra-white glass
5636, 5652 Fornite senza lampadina / Supplied without lamp

[Su richiesta / On request](#)

Diffusore in policarbonato antivandalo / Vandalproof polycarbonate diffuser
(code + **PC**)

5638 Versione dimmerabile / Dimmable version

5638 24V low voltage (code + **24V**)

SUPERMAXI

Da parete o soffitto / Wall or ceiling



SUPERMAXI

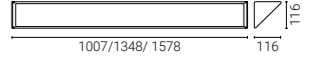

Code	L	Lamp	W	Lm LED	Real Lm	Optic	Class
5212	1007 mm	LED	20	2000	1192	diffuse	II
5213			40	4000	2138		
5221	1348 mm	LED	29	2850	1682		
5223			58	5650	3132		
5232	1578 mm	LED	34	3400	2039		
5233			69	6800	3727		

Diffusore opale in policarbonato / Opal diffuser in polycarbonate

[Su richiesta / On request](#)

Versione dimmerabile / Dimmable version

24V low voltage (code + **24V**)

Versione emergenza / Emergency version

MAXI CON GRIGLIA / WITH GUARD

IK 10

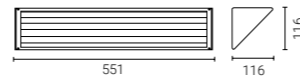

Code	Lamp	W	Lm LED	Real Lm	Optic	Class
5637	2G11	36	-	-	-	I
5653	G24q-3	2x26	-	-		

Diffusore opale in vetro temprato ultrawhite / Opal diffuser in ultra-white glass
Fornite senza lampadina / Supplied without lamp

[Su richiesta / On request](#)

Diffusore in policarbonato antivandalo / Vandalproof polycarbonate diffuser
(code + **PC**)

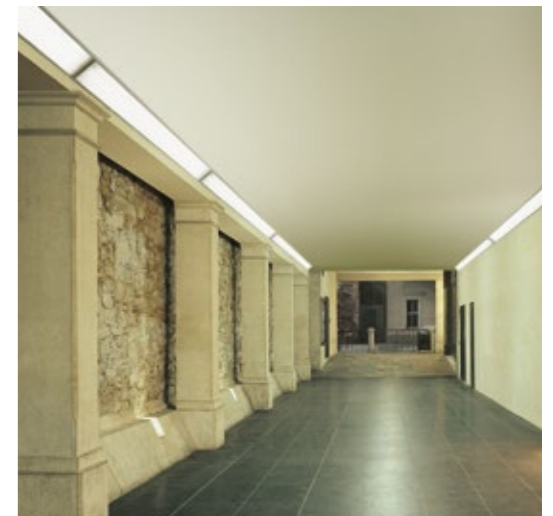

SUPERMAXI CORRIDOR

Funzione Corridor / Corridor function



La Serie SUPERMAXI si completa con la funzione Corridor che consente una gestione intelligente della luce. Grazie al particolare circuito incorporato, dotato di rilevatore di presenza, in condizioni di riposo la lampada emette il 10% di luminosità. Se una persona o un veicolo entrano nel campo del sensore la lampada viene automaticamente riportata alla massima luminosità per un tempo regolabile. Altri settaggi su richiesta. Oltre alla lampada SUPERMAXI è previsto anche un modulo cieco da inserire lungo la linea.

SUPERMAXI enlarges its range with the Corridor function to allow a smart light control. Thanks to a PIR sensor compatible with the incorporated control gear, the luminaires dim down to 10%, but upon detection they will light up to 100% for a pre-set period of time. Other settings available upon request. Blind modules can be inserted between continuous SUPERMAXI lines.

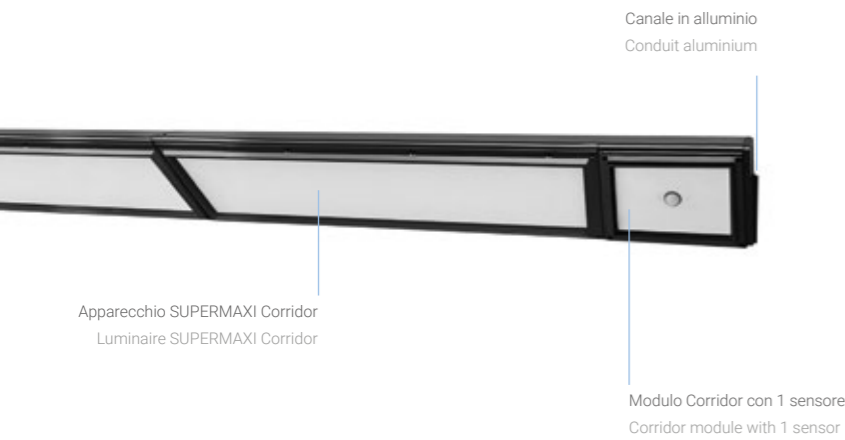

MODULI CORRIDOR / CORRIDOR MODULES



code 5700

code 5704

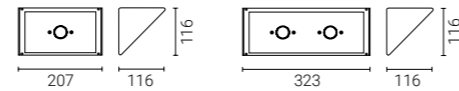

code 5700

code 5704

Code	Description
5700	Modulo Corridor con 1 sensore / Corridor module with 1 sensor
5704	Modulo Corridor con 2 sensori / Corridor module with 2 sensors

Corpo e cornice in alluminio, diffusore e tappi laterali in policarbonato / Housing and frame in aluminium, diffuser and side covers in polycarbonate

Gli apparecchi SUPERMAXI abbinati devono riportare la sigla COR a lato del codice (Richiedere sovrapprezzo) / Add "COR" to the code of combined SUPERMAXI fittings (Ask for surcharge)

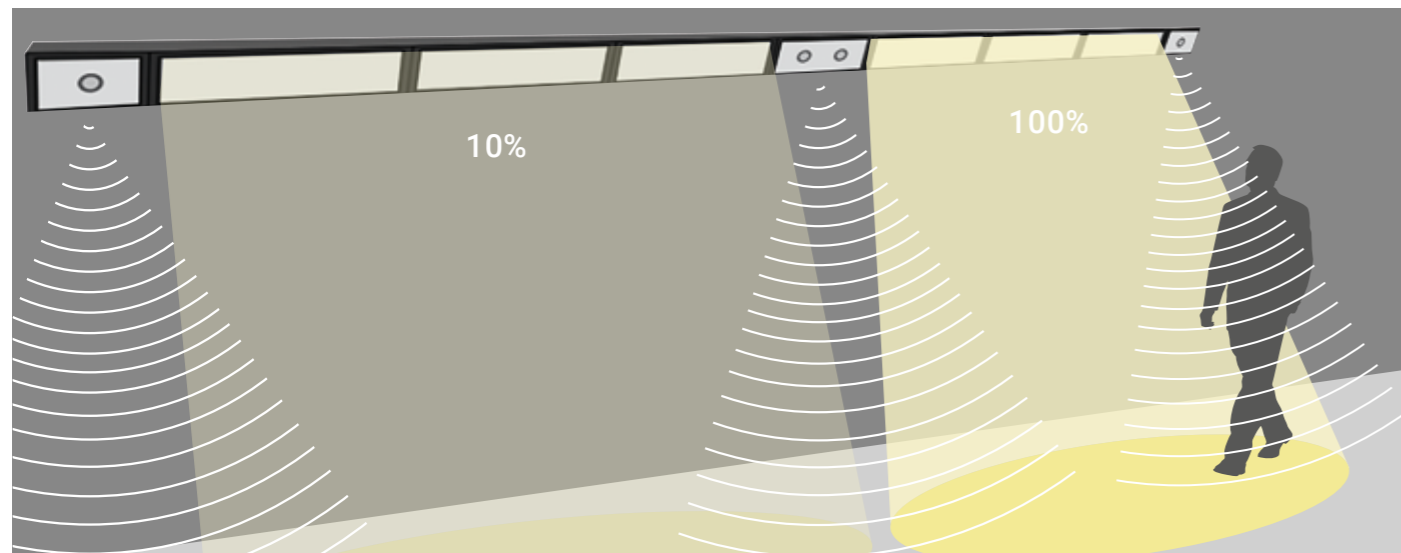

SUPERMAXI

Sistema installazione a canale / Cable trunking installation system



SISTEMA PORTACAVI / CABLE TRUNKING SYSTEM

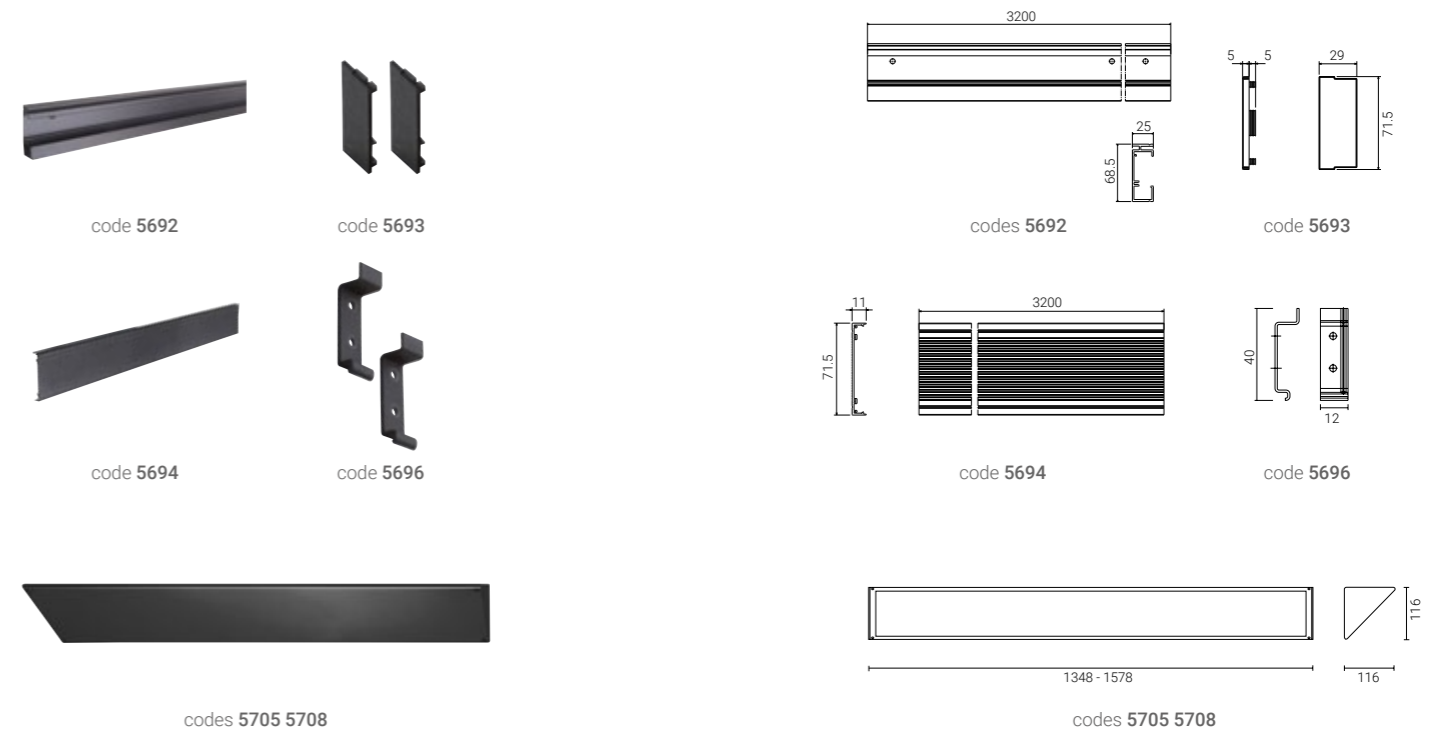

Code	Description
5692	Canale portacavi in alluminio, comprensivo di 3 scatole di derivazione / Aluminium cable trunking, each module contains 3 connections
5693	Tappo laterale unico: sia destro che sinistro / Side cover: one only type for right and left side
5694	Coperchio a incastro in tecnopolimero / Technopolymer snapping cover
5696	Coppia staffe in acciaio per predisporre SUPERMAXI all'aggancio sul canale / Brackets pair to handle SUPERMAXI to the conduit
5705	Modulo cieco L 1348 mm. Stesso corpo in alluminio e tappi laterali di SUPERMAXI. Coperchio in acciaio / Blind module L 1348 mm. Same aluminium housing and side covers of SUPERMAXI. Steel cover
5708	Modulo cieco L 1578 mm. Stesso corpo in alluminio e tappi laterali di SUPERMAXI. Coperchio in acciaio / Blind module L 1578 mm. Same aluminium housing and side covers of SUPERMAXI. Steel cover



SMALL, MIDI, MAXI & SUPERMAXI

Accessori / Accessories

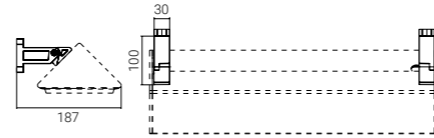
BRACCIO SNODATI / ADJUSTABLE ARMS



Code

5080	 NE - black
	 AG - aluminium grey

Description

Coppia di bracci snodati in alluminio / Aluminium adjustable arms pair



Rotazione consentita / Rotation allowed $\pm 30^\circ$

Per evitare ristagni d'acqua è sconsigliato l'orientamento verso l'alto / To avoid water stagnation, an upward orientation is not recommended

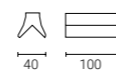
STAFFA A SCATTO / SNAP BRACKET



Code

5091	 NE - black
	 AG - aluminium grey

Description

Staffa a scatto per fissaggio a plafone / Snap bracket for ceiling fixing

MIDI, MAXI 1 staffa / 1 bracket only

SUPERMAXI 2 staffe / 2 brackets



TRIANGOLO



Da tempo TRIANGOLO è un classico intramontabile di Goccia Illuminazione. L'essenziale forma triangolare ha consentito a questa serie eclettica di rimanere sempre attuale e di evolversi in ulteriori applicazioni. Gli apparecchi TRIANGOLO sono disponibili in due dimensioni: piccola in policarbonato e grande in alluminio pressofuso. Le più recenti versioni LED sono state progettate per ottenere grandi prestazioni illuminanti attraverso una cospicua dissipazione del calore e la distribuzione della luce ottimizzata con i nuovi riflettori, fino alla evoluzione più performante e potente con ottiche dedicate - STRADA.

TRIANGOLO has long been a timeless classic of Goccia Illuminazione. The essential triangular shape has allowed this eclectic series to always remain modern and to evolve in further applications. TRIANGOLO luminaires are available in two sizes: small in polycarbonate and large in die-cast aluminum. The most recent LED versions have been designed to achieve great lighting performance through conspicuous heat dissipation and optimized light distribution with the new reflectors, up to the most performing and powerful evolution with dedicated optics - STRADA.

WALL FITTINGS AND POSTS



TRIANGOLO
opal



TRIANGOLO
opal



TRIANGOLO
transparent

TRIANGOLO

Struttura versione LED opale

Diffusore opale in vetro temprato ultrawhite.
TRIANGOLO grande: corpo e cornice fermavetro in alluminio pressofuso a basso tenore di rame.
TRIANGOLO piccolo: corpo e cornice fermavetro in policarbonato.
Ingresso cavi dal retro.

Structure opal LED version

Opal diffuser in tempered ultrawhite glass.
Large TRIANGOLO: body and glazing bead frame in die-cast aluminium with low copper content.
Small TRIANGOLO: body and glazing bead frame in polycarbonate.
Rear cable entry.

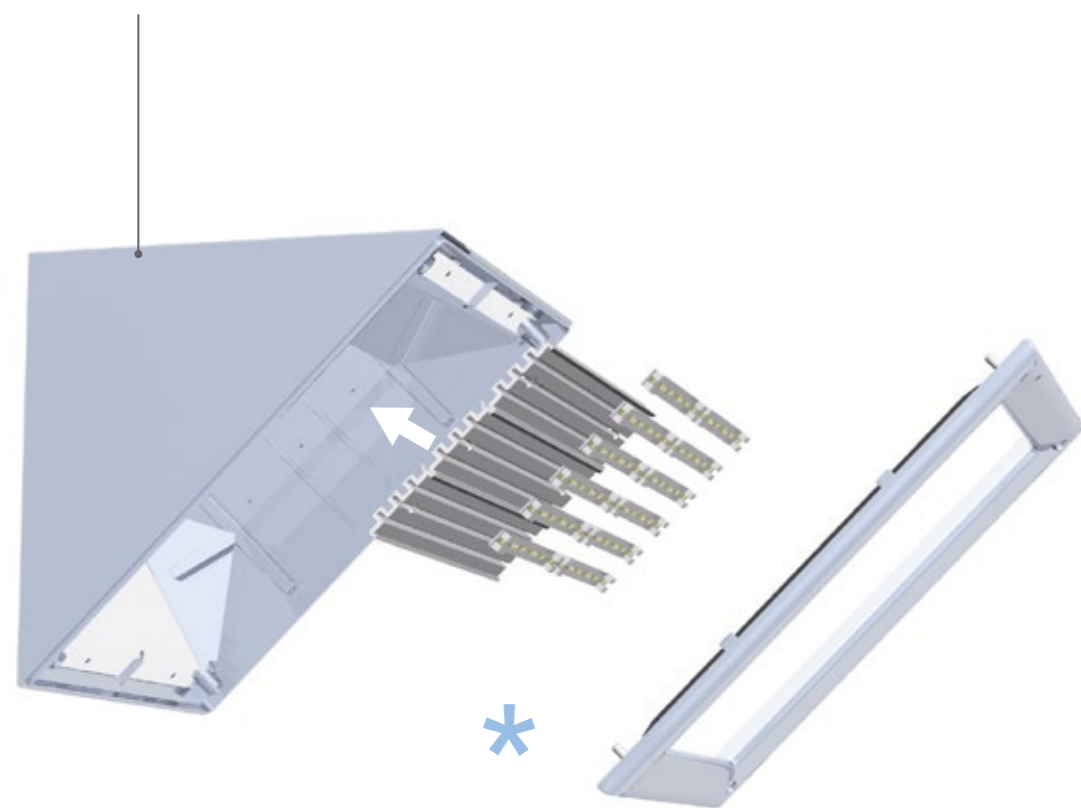

Moduli lineari LED 24V alloggiati su apposito dissipatore per un'omogenea distribuzione della luce sul diffusore.

Linear 24V LED modules mounted on the dedicated heat sink to grant a homogeneous light distribution on the diffuser.

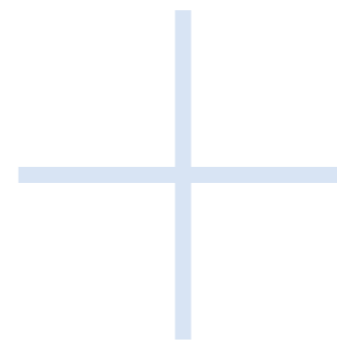

Struttura versione LED trasparente

Diffusore trasparente in vetro temprato ultrawhite.
TRIANGOLO grande: corpo e cornice fermavetro in alluminio pressofuso a basso tenore di rame.
Ingresso cavi dal retro.

Structure transparent LED version

Transparent diffuser in tempered ultrawhite glass.
Large TRIANGOLO: body and glazing bead frame in die-cast aluminium with low copper content.
Rear cable entry.

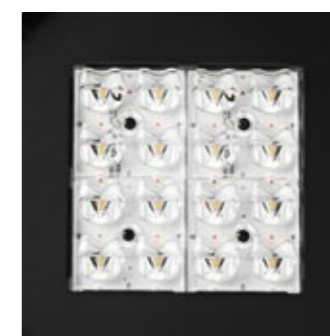

Ottiche STRADA

Scheda da 16 LED di potenza e 4 lenti STRADA 2x2 alloggiata su apposito dissipatore. 3 aperture del fascio: 25° - 100° - Batwing asimmetrico.

STRADA optics

16 power LEDs unit and 4 lenses STRADA 2x2 mounted on the dedicated heat sink. 3 beam angles: 25° - 100° - Batwing asymmetric.



TRIANGOLO

Da parete o palo / Wall or post



TRIANGOLO PICCOLO OPALE / SMALL OPAL

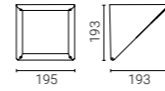

Code			Material	Lamp	W	Lm LED	Real Lm	Optic	Class
4220	● GR - graphite	3K - 3000K 4K - 4000K	polycarbonate	LED	16	2200	1030	diffuse	I
4170	● AG - aluminium grey	-		E 27	75	-	-		II

E 27 L max 120 mm (fornita senza lampadina / supplied without lamp)

Su richiesta / On request
2700K (code + **27K**)

TRIANGOLO

Da parete o palo / Wall or post



TRIANGOLO GRANDE TRASPARENTE / LARGE TRANSPARENT

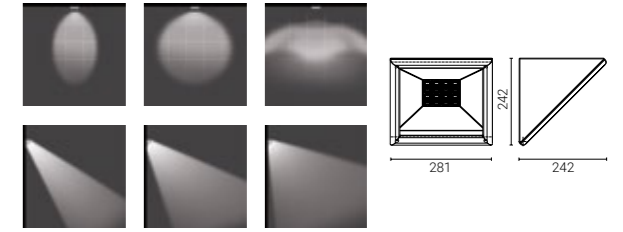

Code			Material	Lamp	W	Lm LED	Real Lm	Optic	Class
4225	● GR - graphite ● AG - aluminium grey	3K - 3000K 4K - 4000K	aluminium	LED	50	6900	5465	100°	II

Ottiche opzionali / Optional optics 25° (code + **25**), batwing asimmetrico / asymmetric (code + **BAT**)

Su richiesta / On request
Versione dimmerabile / Dimmable version

TRIANGOLO GRANDE OPALE / LARGE OPAL

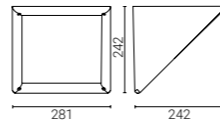

Code			Material	Lamp	W	Lm LED	Real Lm	Optic	Class
4223	● GR - graphite	3K - 3000K 4K - 4000K	aluminium	LED	34,5	3400	1684	diffuse	II
4229	● AG - aluminium grey	-		LED 3h emergency		3400/350	1684/173		
4230	-	-		E 27	150	-	-		

E 27 L max 190 mm (fornita senza lampadina / supplied without lamp)

Su richiesta / On request
4223, 4229 Versione dimmerabile / Dimmable version
4223, 4229 24V low voltage (code + **24V**)

PALI / POSTS H 800-1100

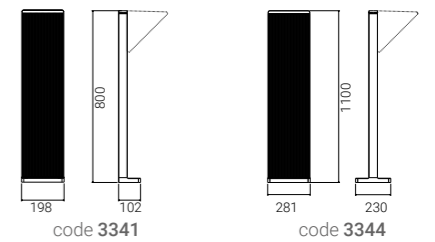

Code	H	Description	Ref. to
3341	800 mm	Palo in alluminio estruso, tappo superiore e basetta in alluminio pressofuso, sottopiede anticorrosione in gomma. Completo di cassetta di derivazione / Post in extruded aluminium, top cover and base in die-cast aluminium, rubber plate against corrosion under the base. Recessed junction box included	code 4220 code 4170
3344	1100 mm		code 4223 code 4229 code 4230 code 4225

Apparecchi TRIANGOLO forniti separatamente / TRIANGOLO fittings supplied separately

Su richiesta / On request
Possibile montaggio di un secondo TRIANGOLO contrapposto / Possible mounting of a second opposite TRIANGOLO
● AG - aluminium grey

VOLTO



VOLTO è un apparecchio speciale nel suo genere, capace di esprimere il suo molteplice potenziale a seconda del tipo di installazione, coadiuvato dai diversi accessori.

Con la sua linea semplice e immediatamente riconducibile alle classiche forme triangolari di Goccia Illuminazione è stato concepito ed implementato per l'illuminazione d'effetto in contesto storico, ovvero cornici o capitelli per volti, arcate, loggiati e portici. Le performanti sorgenti e ottiche LED, la resistente costruzione di dimensioni contenute ed il design moderno pulito hanno reso VOLTO un ottimo strumento illuminotecnico in chiave contemporanea, per un'illuminazione scenografica come wall washer e proiettore.

VOLTO is a special device of its kind, capable of expressing its multiple potential according to the type of installation, completed by the various accessories.

With its simple line and immediately attributable to the classic triangular shapes of Goccia Illuminazione, it was conceived and implemented for effect lighting in a historical context, that is ledges or capitals for facades, arches, loggias and porticoes. The high-performance LED sources and optics, the resistant construction of small dimensions and the clean modern design have made VOLTO an excellent lighting tool in a contemporary key, for scenographic lighting such as wall washers and floodlights.

WALL EFFECTS



VOLTO

VOLTO

Luce omogenea

La particolare forma triangolare con i riflettori dedicati permette una distribuzione omogenea della luce su archi e volti.

Homogeneous light

The particular triangular shape with the dedicated reflectors grants a homogeneous light distribution on arches and vaults.



Struttura

Diffusore in vetro temprato trasparente, corpo e cornice fermavetro in alluminio pressofuso a basso tenore di rame. Posizionabile con orientamento verso l'alto o verso il basso. Ingresso cavi dal retro.

Structure

Transparent and tempered glass diffuser, low copper content die-cast aluminium body and glazing bead frame. Adjustable upwards or downwards. Rear cable entry.

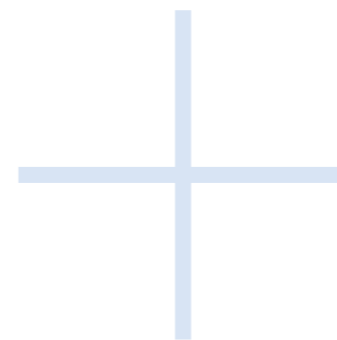

Luce orientabile

L'apparecchio VOLTO può essere installato per orientare la luce verso l'alto o verso il basso. I bracci snodati consentono la rotazione dell'apparecchio fino a $\pm 30^\circ$.

Adjustable light

VOLTO fittings can be installed to direct light upwards or downwards. The adjustable arms allow for fitting rotation up to $\pm 30^\circ$.



Frangiluce

Il frangiluce dà un effetto anti-abbagliante che crea una luminosità mirata e scenografica sulle volte.

Louvers

The louvers give an anti-glare effect, creating scenographic light on vaults.

VOLTO

Effetti a parete / Wall effects



VOLTO

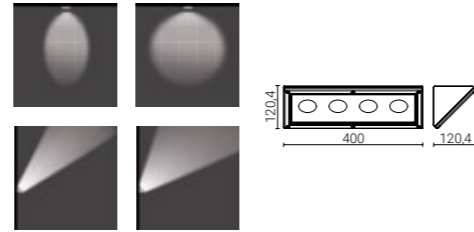

Code	
5863	<ul style="list-style-type: none"> NE - black AG - aluminium grey
	<ul style="list-style-type: none"> 3K - 3000K 4K - 4000K

Lamp	W	Lm LED	Real Lm	Optic
LED	4x6,5	3804	2950	38°

Ottica opzionale / Optional optic 90° (code + 90)

Su richiesta / On request
2700K (code + 27K)
Versione dimmerabile / Dimmable version



VOLTO

Accessori / Accessories



FRANGILUCE / LOUVERS

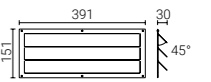

Code	
5864	<ul style="list-style-type: none"> NE - black AG - aluminium grey

Description
Frangiluce con alette orientabili in acciaio zincato e verniciato / Adjustable louvers in galvanized steel and UV resistant coating surface

BRACCI SNODATI / ADJUSTABLE ARMS

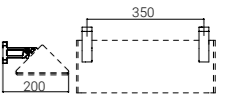

Code	
5081	<ul style="list-style-type: none"> NE - black AG - aluminium grey

Description
Coppia di bracci snodati in alluminio, orientabili verso l'alto o verso il basso / Aluminium wall arms, adjustable upwards or downwards

Rotazione consentita / Rotation allowed $\pm 30^\circ$

SUPPORTI BASCULANTI / TILTING BRACKETS

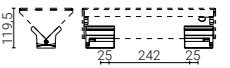

Code	
5066	<ul style="list-style-type: none"> NE - black AG - aluminium grey

Description
Coppia di supporti in alluminio pressofuso / Die-cast aluminium brackets pair

Orientabilità / Adjustable $\pm 15^\circ$

CORINTHIA



L'illuminazione architettonica d'effetto incontra uno stile senza tempo, così nasce CORINTHIA. I cilindri, finemente scanalati, accolgono sorgenti luminose di assoluta avanguardia. Grazie alle specifiche soluzioni tecniche, la versione Ø 120 è basculante ed inclinabile in modo da orientare la luce verso la parete per modularne l'effetto.

Particolare cura è stata posta nella realizzazione del cristallo temperato di chiusura, fresato a filo struttura per impedire ristagni e diffondere in modo ottimale la luce. Potenze e dimensioni rendono CORINTHIA ideale per l'illuminazione di facciate in svariati contesti, urbani o residenziali, classici o, per contrasto, moderni e contemporanei.

Architectural effect lighting meets timeless style, thus CORINTHIA was born. The cylinders, finely carved, welcome light sources of absolute avant-garde. Thanks to the specific technical solutions, the Ø 120 version is tilting in order to adjust the beam direction towards the wall and to modulate the effect of the light. Particular attention has been paid to the realization of the tempered closing glass, milled flush with the structure to prevent stagnation and diffuse the light in an optimal way. Powers and dimensions make CORINTHIA ideal for lighting facades in various contexts, urban or residential, classic or, by contrast, modern and contemporary.

WALL EFFECTS

CORINTHIA Ø 60
1 lightCORINTHIA Ø 60
2 lightsCORINTHIA Ø 120
1 lightCORINTHIA Ø 120
2 lights

CORINTHIA

Cristallo anti ristagno

Per impedire ristagni d'acqua sulla faccia superiore, il cristallo temperato di chiusura è fresato a filo struttura.

Anti-stagnation crystal

The glass, flush with the frame, avoids water stagnation.



Lampada singola o doppia
1 or 2 lights available

Struttura

Diffusore in vetro temprato trasparente. Corpo in alluminio estruso scanalato. Cornici fermavetro e scatola di fissaggio a muro in alluminio pressofuso a basso tenore di rame.

Structure

Transparent tempered glass diffuser. Striated extruded aluminium body. Glazing bead frame and box to fix to wall in die-cast aluminium with low copper content.

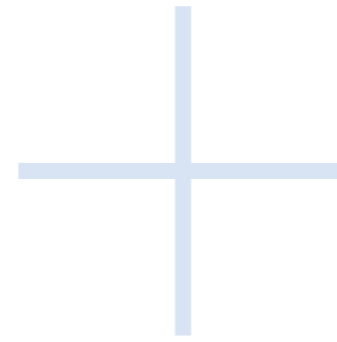

Basculaggio

Le ottiche del Ø 120 sono basculanti e regolabili con un'angolazione fino a $\pm 10^\circ$, in modo da orientare la luce verso la parete per accentuare l'effetto wall-washer.

Tilting

The $\varnothing 120$ optics are adjustable $\pm 10^\circ$, in order to accent the light effect on the wall, when required.



CORINTHIA

Effetti a parete / Wall effects



CORINTHIA Ø 60 mm

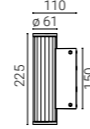

Code

1204	GR - graphite	3K - 3000K
1203	GM - metallized grey	4K - 4000K

Ottiche opzionali / Optional optics
38° (code + **38**), 90° (code + **90**)

Lamp

Lamp	W	Lm LED	Real Lm	Optic
LED	1x3	300	163	1x18°
	2x3	600	326	2x18°

Su richiesta / On request
2700K (code + **27K**)

CORINTHIA

Accessori / Accessories



GIUNTO STAGNO / WATERPROOF CONNECTION

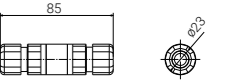

Code

1943

Description

Connessione singola presa-spina 3x2,5 mm² IP68 / Plug/socket connector 3x2,5 mm² IP 68

CORINTHIA Ø 120 mm

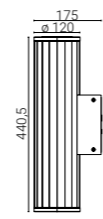

Code

1213		
1232	GR - graphite	3K - 3000K
1208	GM - metallized grey	4K - 4000K
1231		

Ottiche opzionali / Optional optics
1213, 1208 38° (code + **38**), 1232, 1231 50° (code + **50**),
1213, 1232, 1208, 1231 90° (code + **90**)

Sorgente luminosa basculante / Adjustable light source ±10°

Lamp

Lamp	W	Lm LED	Real Lm	Optic
LED	1x11	1405	1090	1x18°
	1x18	2761	2000	1x18°
	2x11	2810	2180	2x18°
	2x18	5522	4000	2x18°

Su richiesta / On request
2700K (code + **27K**)
Versione dimmerabile / Dimmable version
Versione emergenza / Emergency version



DOWNLIGHT

DOWNLIGHT

LUX SHOWER



Le soluzioni per l'illuminazione downlight di LUX SHOWER si articolano in tre diverse dimensioni per l'installazione sulla superficie di partizioni orizzontali e coperture, con numerose varianti di apertura dei fasci luminosi. Le tre dimensioni e le diverse portate illuminanti trovano una cifra estetica e di stile adatta al tipo ed all'altezza di installazione, offrendo tutte una solida struttura in alluminio e vetro temprato per garantire una tenuta IP 65.

The LUX SHOWER downlight solutions are divided into three different sizes for installation on the surface of horizontal partitions and roofs, with numerous variations of the light beam angles. Three dimensions and the different illuminating ranges find an aesthetic and style reason suited to the type and height of installation, all offering a solid structure in aluminum and tempered glass to guarantee an IP 65 rating.

CEILING

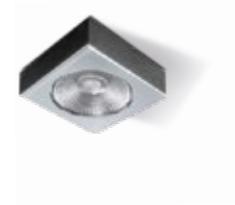

LUX SHOWER
30



LUX SHOWER
100

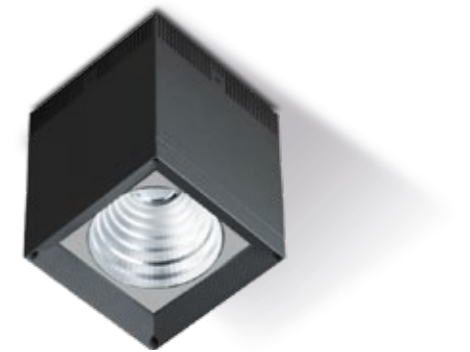

LUX SHOWER
200

LUX SHOWER

Struttura

Diffusore in vetro temperato. Corpo lampada, basetta e cornice fermavetro in alluminio primario anticorrosione a basso tenore di rame. Ingresso cavi dal retro.

Structure

Tempered glass diffuser. Light body, base and frame in primary low copper content aluminium alloy, UV and harsh conditions resistant. Rear cable entry.

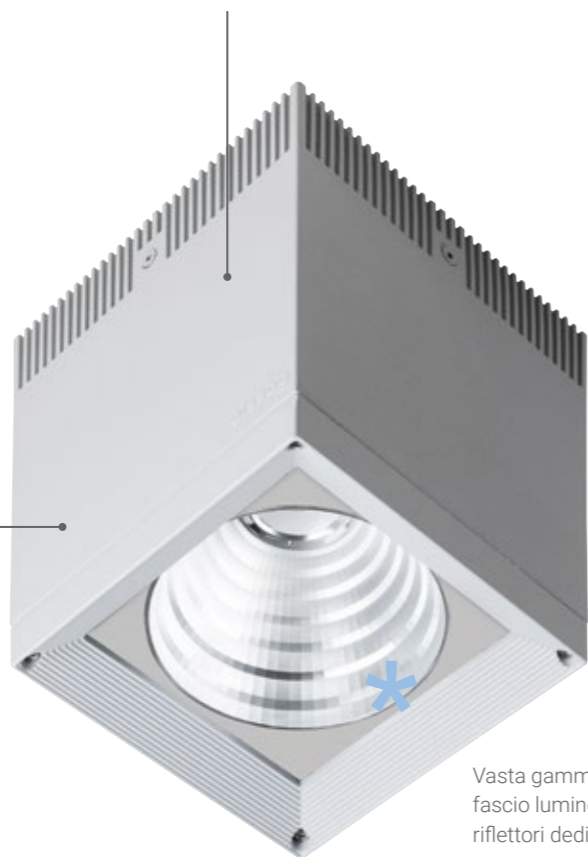

Vasta gamma di aperture del fascio luminoso grazie a lenti e riflettori dedicati.

Wide range of beam angles available thanks to the incorporated optical reflectors

Dimensioni

Disponibili in 3 dimensioni con 36-102-200 mm di altezza.

Dimensions

Available in three dimensions with 36-102-200 mm height.

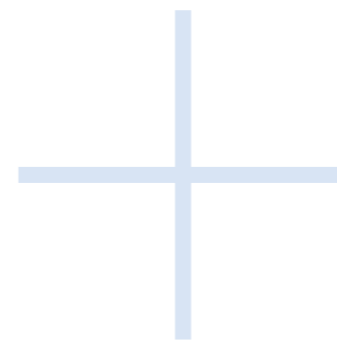

Minimo spessore

Apparecchio di soli 36 mm di spessore con potente ottica LED integrata funzionante a 230V. Tre angoli di diffusione: 12°- 40°- 90° e versione opale.

Minimum thickness

Ceiling fixture with only 36 mm thickness and 230V LED module inside. 3 beam angles: 12°- 40°- 90° and opal version.



Potenza in un minicubo

L'apparecchio di soli 100 mm di lato, grazie al LED 15W con parabola integrata, offre un'elevata resa luminosa. 3 angoli di diffusione: 18°-38°- 90° e vetro opale.

Minimal design and high efficiency

A 100x100 mm minicube with 15W LED and optical reflectors ensures high performances. 3 beam angles: 18°- 38°- 90° and opal glass.

LUX SHOWER

Soffitto / Ceiling



LUX SHOWER 30

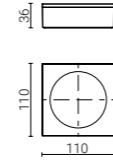

Code	
1221	<ul style="list-style-type: none"> AN - anthracite AG - aluminium grey
1222	<ul style="list-style-type: none"> BI - white

Ottiche opzionali / Optional optics
 1221 12° (code + **12**), 90° (code + **90**)
 1222 Versione opale / Opal version

Modulo LED a tensione di rete, compatibile con dimmer a taglio di fase /
 Mains voltage LED module, compatible with most phase-cut dimmers

Ingresso cavi laterale mediante distanziale cod. 5351 / Side cable entry by the
 accessory code 5351 (page 76)

Lamp	W	Lm LED	Real Lm	Optic
LED	10	1100	750	40°
			363	diffuse

Su richiesta / On request
 2700K (code + **27K**)
 12-24V low voltage

LUX SHOWER

Soffitto / Ceiling



LUX SHOWER 100

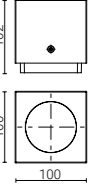

Code	
1225	<ul style="list-style-type: none"> AN - anthracite AG - aluminium grey
1226	<ul style="list-style-type: none"> BI - white

Ottiche opzionali / Optional optics
 1225 18° (code + **18**), 90° (code + **90**)
 1226 Versione opale / Opal version
 Modulo LED a tensione di rete, compatibile con dimmer a taglio di fase /
 Mains voltage LED module, compatible with most phase-cut dimmers

Lamp	W	Lm LED	Real Lm	Optic
LED	15	1575	950	38°
			419	diffuse

Su richiesta / On request
 2700K (code + **27K**)
 10=52V low voltage

LUX SHOWER 200

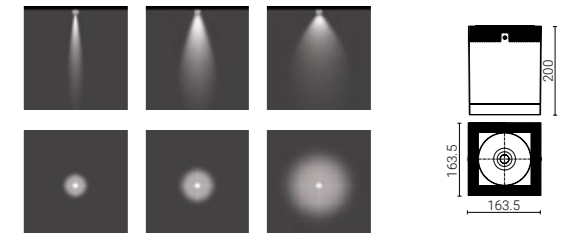
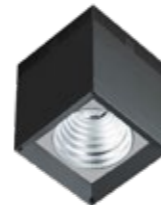

Code	
1087	<ul style="list-style-type: none"> AN - anthracite AG - aluminium grey BI - white

Ottiche opzionali / Optional optics
 18° (code + **18**), 70° (code + **70**)

Lamp	W	Lm LED	Real Lm	Optic
LED	23	3329	2434	38°

Su richiesta / On request
 2700K (code + **27K**)
 Versione dimmerabile / Dimmable version



DOWNLIGHT

DOWNLIGHT

KYKLO



Nata come una nuova serie per l'illuminazione downlight a soffitto, KYKLO si presenta nella sua versione rotonda con spessore ridotto per soddisfare le peculiarità della luce di questa applicazione con un disegno essenziale. Una volontà estetica che permette a KYKLO di enfatizzare la purezza del diffusore in vetro a filo, offrendo la versatilità illuminotecnica delle sorgenti LED e delle ottiche studiate per la serie.

Developed as a new series for ceiling mounted downlighting, KYKLO presents itself in its round version with reduced thickness to satisfy the uniqueness of this application's light, with an essential design. An aesthetic desire which enables KYKLO to emphasize the purity of the glass flush diffuser, with all the lighting versatility of LED sources and optics designed for the series.

CEILING



KYKLO
40



KYKLO
40
opal

KYKLO

Il diffusore circolare in vetro a filo col corpo lampada definisce un bordo raffinato che conferisce leggerezza ed uno stile inconfondibile.

The round glass diffuser flush with the lamp body defines a refined edge which adds lightness and a distinctive style.



Struttura

Solida struttura in alluminio pressofuso a basso tenore di rame e viti inox. Sorgenti LED dedicate e vetro temperato ultrawhite. Ingresso cavi dal retro.

Structure

Low copper content die-cast aluminium solid structure and stainless steel screws. Dedicated LED sources and ultrawhite tempered glass. Rear cable entry.

Minimo spessore

L'altezza minima della lampada permette un'installazione a 230V di superficie ed è ottimizzata per consentire l'impiego di diverse ottiche per diffondere la luce.

Minimum thickness

The minimum height of the lamp is designed for 230V surface installation and is optimised to enable the use of different light diffusion optics.

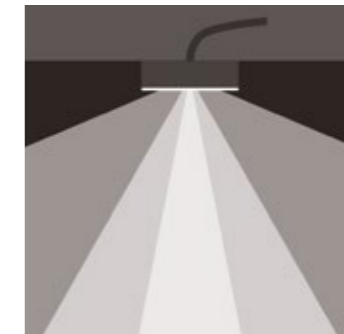
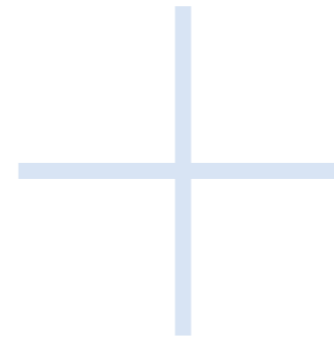

Ottiche

Ottiche e lenti speciali per diverse aperture del fascio luminoso.

Optics

Special optics and lenses for different light beam angles.









KYKLO

Soffitto / Ceiling

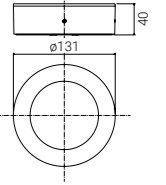

KYKLO 40



Code		Lamp	W	Lm LED	Real Lm	Optic
1241	 AN - anthracite	LED	10	1100	750	40°
	 AG - aluminium grey					
	 BI - white					
	3K - 3000K 4K - 4000K					

Lamp	W	Lm LED	Real Lm	Optic
LED	10	1100	750	40°

Ottiche opzionali / Optional optics

12° (code + 12), 90° (code + 90)

Modulo LED a tensione di rete, compatibile con dimmer a taglio di fase /
Mains voltage LED module, compatible with most phase-cut dimmers

Su richiesta / On request



2700K (code + 27K)

12-24V low voltage

Ottica a nido d'ape / Honeycomb optic 10° (code + HC)

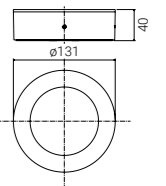
KYKLO 40 OPAL



Code		Lamp	W	Lm LED	Real Lm	Optic
1242	 AN - anthracite	LED	10	1100	363	diffuse
	 AG - aluminium grey					
	 BI - white					
	3K - 3000K 4K - 4000K					

Lamp	W	Lm LED	Real Lm	Optic
LED	10	1100	363	diffuse

Versione opale / Opal version

Modulo LED a tensione di rete, compatibile con dimmer a taglio di fase /
Mains voltage LED module, compatible with most phase-cut dimmers

Su richiesta / On request

2700K (code + 27K)

12-24V low voltage

PLAFONIERE DA
PARETE O SOFFITTO

WALL OR CEILING
FITTINGS

LUNETTE



Per l'installazione a soffitto e a parete LUNETTE porta un'eleganza discreta e armonia delle proporzioni, definite dal ridotto spessore e dai diametri degli anelli concentrici. Un disegno puro e lineare per enfatizzare l'effetto luminoso omogeneo e permettere un'ottima illuminazione nelle diverse versioni. L'altro lato di LUNETTE, celato negli ingombri minimi, offre tutti gli accorgimenti tecnici e di installazione facilitata frutto dell'esperienza di Goccia Illuminazione, nonché soluzioni LED d'avanguardia, tra cui la luce intelligente regolabile con rilevatori di presenza ed in emergenza.

For ceiling and wall installation, LUNETTE brings a discreet elegance and harmony of proportions, defined by the reduced thickness and diameters of the concentric rings. A pure and linear design to emphasize the homogeneous light effect and to provide excellent lighting in the different versions. The other side of LUNETTE, concealed in its minimal dimensions, offers all the technical and easy installation features resulting from Goccia Illuminazione's experience, as well as cutting-edge LED solutions, including intelligent lighting with presence detectors and emergency versions.

WALL OR CEILING

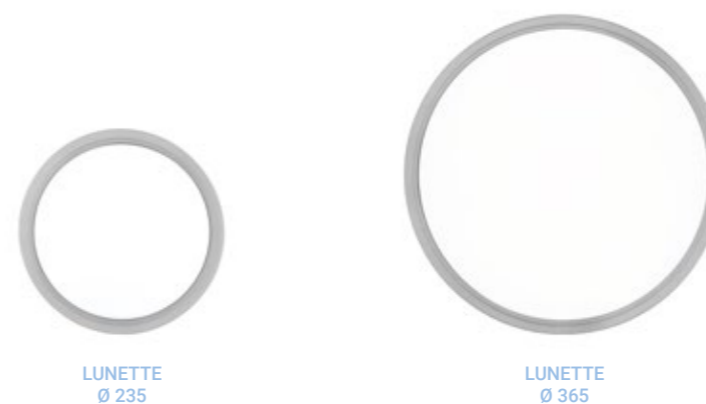

LUNETTE

Struttura

Corpo lampada in lega di alluminio primario a basso contenuto di rame. Guarnizioni di tenuta in silicone. Diffusore in policarbonato opale anti UV, IK 10 antivandalo.

Structure

Body in low copper content primary aluminium alloy. Silicone sealing gasket. Opal polycarbonate diffuser UV resistant, IK 10 vandalproof.

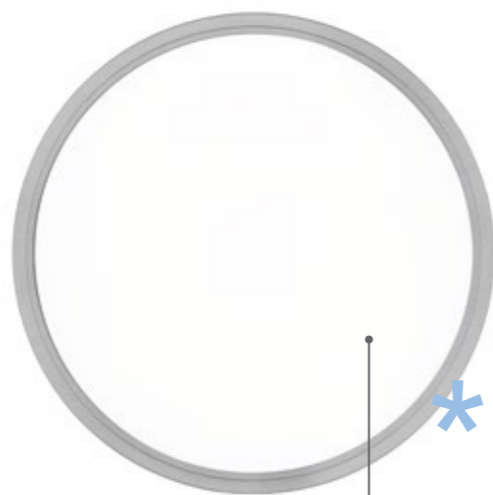

Nessuna vite frontale a vista.
No visible frontal screws.

Luce uniforme

Per una migliore distribuzione della luce sono stati inseriti numerosi LED di dimensioni ridotte. Niente ombre anche nelle versioni con sensore.

Uniform lighting

Several small LEDs enable a soft and well lighting distribution. No shadows on the glass also in the version with sensor.

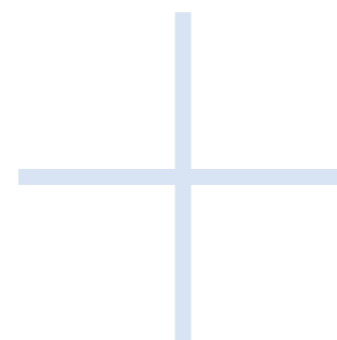

Alimentazione passante

Il doppio ingresso cavi permette l'alimentazione passante. L'accessorio distanziale consente l'ingresso cavi laterale.

Through wiring available

The double cable entry permits an easy through wiring installation. Spacer optional accessory allows a side cable entry.



Installazione facilitata

La cornice si fissa sulla base con rotazione a scatto. Un grano laterale, avvitabile con la chiave in dotazione, garantisce il bloccaggio permanente.

Easy installation

The frame can easily be fixed to the base by a snapping rotation. After that - hands free - a side grub can be screwed by the key supplied for a permanent installation.

LUNETTE STANDARD

Funzionamento ON / OFF.
ON / OFF operating.

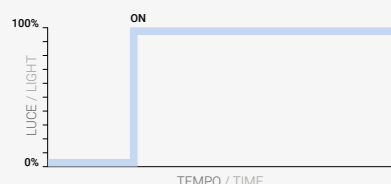

LUNETTE STANDARD + EMERGENCY 3h

Funzionamento standard ON / OFF con innesto automatico dell'emergenza in caso di black-out.

Standard ON / OFF operating with automatic emergency ignition in case of black-out.

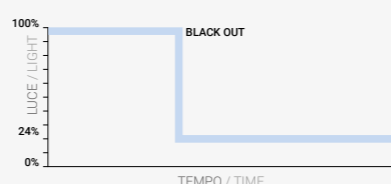

LUNETTE INTELLIGENT ILLUMINATION

Rilevatore di presenza: accensione al 100% al passaggio.
Dimmer: regolazione luce notturna 0=30%.
Settaggi: area di rilevamento, timer, crepuscolare.

Motion sensor: 100% ignition upon detection.
Dimmer: night light adjustment 0=30%.
Settings: detection area, timing, daylight.

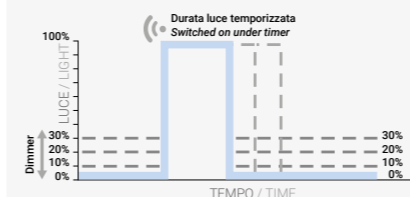

LUNETTE INTELLIGENT ILLUMINATION + EMERGENCY 3h

Combinazione funzionamento con rilevatore di presenza crepuscolare + emergenza al black-out.

Combination of motion sensor + emergency functions.

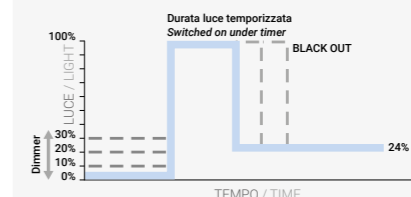

LUNETTE

Parete o soffitto / Wall or ceiling



LUNETTE Ø 235 mm



Code	Lamp	W	Lm LED	Real Lm	Optic
9201	LED	15	1500	890	diffuse
9202	LED + 3h emergency		1500/360	890/130	
9203	LED + intelligent illumination		1500	890	
9204	LED + intelligent illumination + 3h emergency		1500/360	890/130	

- AN - anthracite
- AG - aluminium grey
- BI - white

3K - 3000K
4K - 4000K

Su richiesta / On request

9201, 9202 Versione dimmerabile / Dimmable version

LUNETTE Ø 365 mm

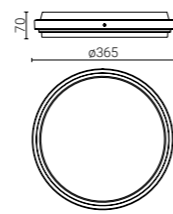

Code	Lamp	W	Lm LED	Real Lm	Optic
9206	LED	25	3300	2454	diffuse
9207	LED + 3h emergency		3300/360	2454/130	
9208	LED + intelligent illumination		3300	2454	
9209	LED + intelligent illumination + 3h emergency		3300/360	2454/130	

- AN - anthracite
- AG - aluminium grey
- BI - white

3K - 3000K
4K - 4000K

Su richiesta / On request

9206, 9207 Versione dimmerabile / Dimmable version

LUNETTE

Accessori / Accessories



DISTANZIALI / SPACERS



code 9211



code 9212

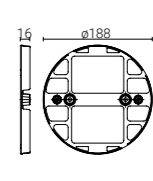

code 9211

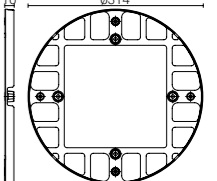

code 9212

Code	Description	Ref. to
9211	Distanziale per ingresso cavi laterale, cablaggio entra/esci consentito / Spacer for side cable entry, through wiring allowed	code 9201 code 9202 code 9203 code 9204
9212		code 9206 code 9207 code 9208 code 9209



PLAFONIERE DA
PARETE O SOFFITTO

WALL OR CEILING
FITTINGS

DOCKS



DOCKS reinterpreta gli apparecchi di uso e gusto navale, utilizzandone i materiali tipici come l'acciaio inossidabile AISI 316L e l'alluminio marino. Proposte nelle classiche forme con e senza griglia o con palpebra, sono ideali per l'installazione in esterni particolarmente esposti agli agenti atmosferici ed alla corrosione.

Il design classico di DOCKS, la nobiltà e la robustezza dei materiali ne fanno la lampada ideale per strutture in condizioni climatiche difficili e per ogni applicazione si presti ad un connubio di resistenza ed estetica raffinata.

DOCKS reinterprets the appliances of naval use and taste, using typical materials such as AISI 316L stainless steel and marine aluminum. Proposed in the classic shapes with and without guard or with eyelid, they are ideal for outdoor installation particularly exposed to weathering and corrosion.

The classic design of DOCKS, the nobility and the robustness of the materials make it the ideal lamp for structures in difficult climatic conditions and for each application needing a combination of resistance and refined aesthetics.

WALL OR CEILING



DOCKS
with ring



DOCKS
with guard



DOCKS
with eyelid

DOCKS

Struttura

Diffusore in vetro opale stampato o policarbonato opale IK 10 antivandalo. Guarnizioni di tenuta in silicone. Corpo in alluminio pressofuso a basso tenore di rame o inox AISI 316L. Base in alluminio pressofuso. Piattello interno reggicablaggio in Al 99,8 con ingresso cavi dal retro. Viti inox.

Structure

Moulded opal glass or IK 10 vandalproof opal polycarbonate diffuser. Silicone sealing gaskets. Body in low copper content die-cast aluminium or AISI 316L stainless steel. Die-cast aluminium base. Internal wire holder plate in Al 99,8 with cable entry from the back. Stainless steel screws.

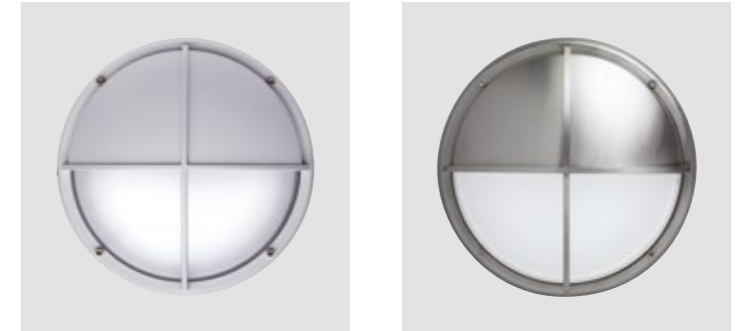
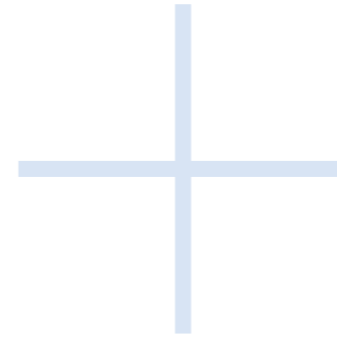

Materiali

Alluminio marino con viti inox, resistente finitura a doppia verniciatura: decapaggio, passivazione cromica trivalente, fondo epossidico e verniciatura con polveri poliestere. Acciaio inox AISI 316L con viti inox, maschera tornita da lastra, finitura spazzolata e satinata.

Materials

Marine aluminium + stainless steel screws, resistant finishing with double paint coating: pickling, trivalent chromic passivation, epoxy bottom and polyester powder coating. AISI 316L stainless steel, brushed and thin satinated. Stainless steel screws.

DOCKS STANDARD

Funzionamento ON / OFF.
ON / OFF operating.

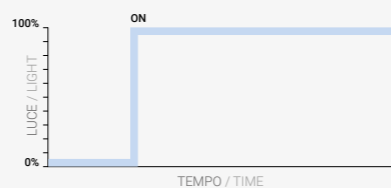

DOCKS STANDARD + EMERGENCY 3h

Funzionamento standard ON / OFF con innesto automatico dell'emergenza in caso di black-out.

Standard ON / OFF operating with automatic emergency ignition in case of black-out.

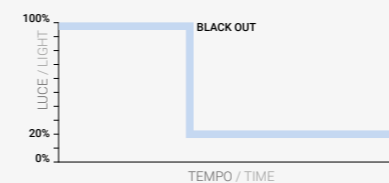

DOCKS INTELLIGENT ILLUMINATION

Rilevatore di presenza: accensione al 100% al passaggio.

Dimmer: regolazione luce notturna 0-30%.

Settaggi: area di rilevamento, timer, crepuscolare.
Motion sensor: 100% ignition upon detection.
Dimmer: night light adjustment 0-30%.
Settings: detection area, timing, daylight.

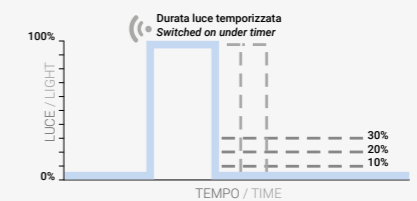



DOCKS CON ANELLO / WITH RING



aluminium

AISI 316L stainless steel

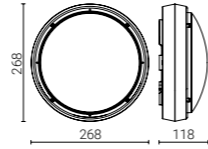

Code	Material	Lamp	W	Lm LED	Real Lm	Optic			
9101	aluminium	LED	15	1575	600	diffuse			
9104*		LED + 3h emergency		1575/240	600/111				
4470		LED + intelligent illumination		1575	600				
4472*		<ul style="list-style-type: none"> GR - graphite GM - metallized grey BI - white 		3K - 3000K	4K - 4000K				
9102									
9105*									
9000		E27		75	-		-		
9060*									
9106		AISI 316L stainless steel		LED	15		1575	600	diffuse
9108*				LED + 3h emergency			1575/240	600/111	
4474	LED + intelligent illumination		1575	600					
4475*	<ul style="list-style-type: none"> IN - stainless steel 		3K - 3000K	4K - 4000K					
9107									
9109*									
9020	E27		75	-		-			
9070*									

*Diffusore in policarbonato antivandalo IK10 / IK10 vandalproof polycarbonate diffuser

Modulo LED a tensione di rete, compatibile con dimmer a taglio di fase / Mains voltage LED module, compatible with most phase-cut dimmers
E27 L max 160 mm (fornite senza lampadina / supplied without lamp)

Su richiesta / On request
2700K (code + **27K**)

Versione LED emergenza + illuminazione intelligente / Emergency + intelligent illumination LED version



DOCKS CON GRIGLIA / WITH GUARD



aluminium

AISI 316L stainless steel

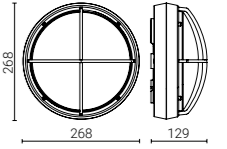

Code	Material	Lamp	W	Lm LED	Real Lm	Optic			
9117	aluminium	LED	15	1575	600	diffuse			
9121*		LED + 3h emergency		1575/240	600/111				
4478		LED + intelligent illumination		1575	600				
4479*		<ul style="list-style-type: none"> GR - graphite GM - metallized grey BI - white 		3K - 3000K	4K - 4000K				
9119									
9122*									
9005		E27		75	-		-		
9064*									
9130		AISI 316L stainless steel		LED	15		1575	600	diffuse
9133*				LED + 3h emergency			1575/240	600/111	
4487	LED + intelligent illumination		1575	600					
4488*	<ul style="list-style-type: none"> IN - stainless steel 		3K - 3000K	4K - 4000K					
9131									
9134*									
9025	E27		75	-		-			
9074*									

*Diffusore in policarbonato antivandalo IK10 / IK10 vandalproof polycarbonate diffuser

Modulo LED a tensione di rete, compatibile con dimmer a taglio di fase / Mains voltage LED module, compatible with most phase-cut dimmers
E27 L max 160 mm (fornite senza lampadina / supplied without lamp)

Su richiesta / On request
2700K (code + **27K**)

Versione LED emergenza + illuminazione intelligente / Emergency + intelligent illumination LED version

DOCKS

Parete o soffitto / Wall or ceiling



DOCKS CON PALPEBRA / WITH EYELID



aluminium AISI 316L stainless steel

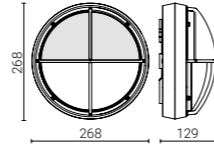

Code	Material	Lamp	W	Lm LED	Real Lm	Optic
9124	aluminium	LED	15	1575	298	diffuse
9127*						
4480		LED + 3h emergency		1575/240	298/55	
4481*						
9125		LED + intelligent illumination	1575	298		
9128*						
9011	AISI 316L stainless steel	E27	75	-	-	diffuse
9067*						
9136		LED	15	1575	298	
9138*						
4489		LED + 3h emergency		1575/240	298/55	
4413*			LED + intelligent illumination	1575	298	
9137						
9139*						
9031	-	E27	75	-	-	-
9077*						

*Diffusore in policarbonato antivandalo IK10 / IK10 vandalproof polycarbonate diffuser

Modulo LED a tensione di rete, compatibile con dimmer a taglio di fase / Mains voltage LED module, compatible with most phase-cut dimmers
E27 L max 160 mm (fornite senza lampadina / supplied without lamp)

Su richiesta / On request

2700K (code + **27K**)

Versione LED emergenza + illuminazione intelligente / Emergency + intelligent illumination LED version



KASKO



Le forme pulite, i materiali tecnici e le finiture pregiate rendono KASKO ideale per ogni contesto architettonico di illuminazione esterna caratterizzato da stile e resistenza nel tempo. Una lampada robusta, IP65, concepita fin dall'origine nella sua versione antivandalo per gli spazi pubblici, KASKO nasce per garantire la tenuta stagna e le qualità illuminotecniche anche nelle condizioni di installazione più difficili.

The clean shapes, the technical materials and the fine finishes make KASKO ideal for any architectural context of outdoor lighting characterized by style and resistance over time. A sturdy lamp, IP65, conceived from the outset in its vandal-proof version for public spaces, KASKO was created to guarantee watertightness and lighting qualities even in the most difficult installation conditions.

WALL OR CEILING



KASKO Ø 198
with ring



KASKO Ø 198
with guard



KASKO Ø 198
with eyelid



KASKO Ø 260
with ring



KASKO Ø 260
with guard



KASKO Ø 260
with eyelid



KASKO oval
with guard



KASKO oval
with eyelid

KASKO

Struttura

Diffusore in vetro opale stampato o policarbonato opale IK10 antivandalo. Guarnizioni di tenuta in silicone. Corpo in alluminio pressofuso a basso tenore di rame. Base in alluminio pressofuso. Piattello interno reggicablaggio in Al 99,8. Viti a brugola in acciaio inox.

Structure

Moulded opal glass or IK 10 vandalproof opal polycarbonate diffuser. Silicone sealing gaskets. Low copper content die-cast aluminium body. Die-cast aluminium base. Internal wire holder plate in Al 99,8. Stainless steel Allen key screws.



* Alimentazione passante possibile
Through wiring allowed

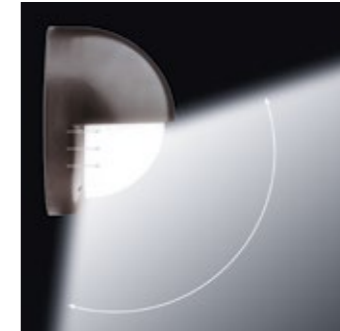
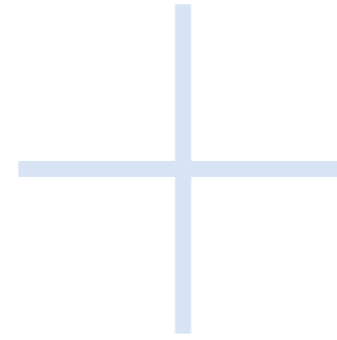

Irraggiamento verso il basso

La forma emisferica è stata progettata per allontanare dalla base la lampada portandola nella posizione migliore per diffondere più efficacemente la luce. Il portalampana è posizionato in alto, grazie al precablaggio con cavi resistenti al calore. La luce viene così irradiata verso il basso.

Downward light distribution

KASKO has been designed with its semispherical shape to provide maximum illumination. The lampholder is installed on the top and the light is oriented downwards.

KASKO STANDARD

Funzionamento ON / OFF.
ON / OFF operating.

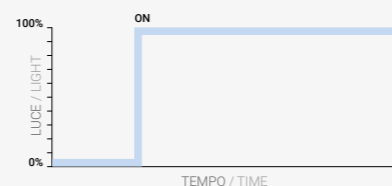

KASKO STANDARD + EMERGENCY 3h

Funzionamento standard ON / OFF con innesto automatico dell'emergenza in caso di black-out.

Standard ON / OFF operating with automatic emergency ignition in case of black-out.

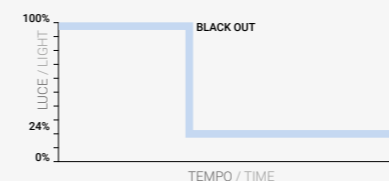

KASKO INTELLIGENT ILLUMINATION

Rilevatore di presenza: accensione al 100% al passaggio.

Dimmer: regolazione luce notturna 0-30%.

Settaggi: area di rilevamento, timer, crepuscolare.
Motion sensor: 100% ignition upon detection.
Dimmer: night light adjustment 0-30%.
Settings: detection area, timing, daylight.

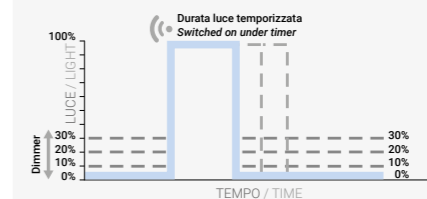



KASKO CON ANELLO / WITH RING Ø 198 mm

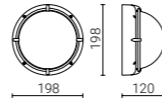

Code	
8410	● GR - graphite
8490*	○ BI - white

*Diffusore in policarbonato antivandalo IK10 / IK10 vandalproof polycarbonate diffuser
E27 L max 117 mm (fornite senza lampadina / supplied without lamp)

Lamp	W	Lm LED	Real Lm	Optic
E27	100	-	-	diffuse
	75	-	-	

Su richiesta / On request
● AG - aluminium grey

KASKO CON ANELLO / WITH RING Ø 260 mm

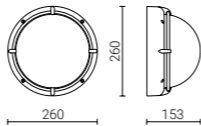

Code	
9150	● GR - graphite ○ BI - white
9154*	
9151	
9155*	
9152	
9156*	
8420	3K - 3000K 4K - 4000K
8495*	-

*Diffusore in policarbonato antivandalo IK10 / IK10 vandalproof polycarbonate diffuser
Modulo LED a tensione di rete, compatibile con dimmer a taglio di fase / Mains voltage LED module, compatible with most phase-cut dimmers
E27 L max 145 mm (fornite senza lampadina / supplied without lamp)

Lamp	W	Lm LED	Real Lm	Optic
LED	15	1575	645	diffuse
LED + 3h emergency		1575/240	645/119	
LED + intelligent illumination		1575	645	
E27	150	-	-	diffuse
	100	-	-	

Su richiesta / On request
2700K (code + 27K)
Versione LED emergenza + illuminazione intelligente / Emergency + intelligent illumination LED version
● AG - aluminium grey



KASKO CON GRIGLIA / WITH GUARD Ø 198 mm

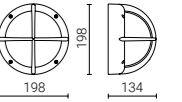

Code	
8310	● GR - graphite
8390*	○ BI - white

*Diffusore in policarbonato antivandalo IK10 / IK10 vandalproof polycarbonate diffuser
E27 L max 117 mm (fornite senza lampadina / supplied without lamp)

Lamp	W	Lm LED	Real Lm	Optic
E27	100	-	-	diffuse
	75	-	-	

Su richiesta / On request
● AG - aluminium grey

KASKO CON GRIGLIA / WITH GUARD Ø 260 mm

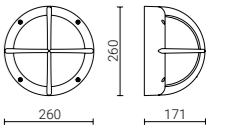

Code	
9160	● GR - graphite ○ BI - white
9164*	
9161	
9165*	
9162	
9166*	
8320	3K - 3000K 4K - 4000K
8395*	-

*Diffusore in policarbonato antivandalo IK10 / IK10 vandalproof polycarbonate diffuser
Modulo LED a tensione di rete, compatibile con dimmer a taglio di fase / Mains voltage LED module, compatible with most phase-cut dimmers
E27 L max 145 mm (fornite senza lampadina / supplied without lamp)

Lamp	W	Lm LED	Real Lm	Optic
LED	15	1575	645	diffuse
LED + 3h emergency		1575/240	645/119	
LED + intelligent illumination		1575	645	
E27	150	-	-	diffuse
	100	-	-	

Su richiesta / On request
2700K (code + 27K)
Versione LED emergenza + illuminazione intelligente / Emergency + intelligent illumination LED version
● AG - aluminium grey



KASKO CON PALPEBRA / WITH EYELID Ø 198 mm

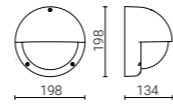

Code	
8610	● GR - graphite
8690*	○ BI - white

*Diffusore in policarbonato antivandalo IK10 / IK10 vandalproof polycarbonate diffuser
E27 L max 117 mm (fornite senza lampadina / supplied without lamp)

Lamp	W	Lm LED	Real Lm	Optic
E27	75	-	-	diffuse
	60	-	-	

Su richiesta / On request
● AG - aluminium grey

KASKO CON PALPEBRA / WITH EYELID Ø 260 mm

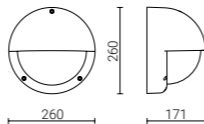

Code	
9170	● GR - graphite ○ BI - white
9174*	
9171	
9175*	
9172	
9176*	
8620	-
8695*	-

*Diffusore in policarbonato antivandalo IK10 / IK10 vandalproof polycarbonate diffuser
Modulo LED a tensione di rete, compatibile con dimmer a taglio di fase / Mains voltage LED module, compatible with most phase-cut dimmers
E27 L max 145 mm (fornite senza lampadina / supplied without lamp)

Lamp	W	Lm LED	Real Lm	Optic
LED	-	1575	303	diffuse
LED + 3h emergency	15	1575/240	303/59	
LED + intelligent illumination	-	1575	303	
E27	100	-	-	
	75	-	-	

Su richiesta / On request
2700K (code + 27K)
Versione LED emergenza + illuminazione intelligente / Emergency + intelligent illumination LED version
● AG - aluminium grey



KASKO OVALE CON GRIGLIA / OVAL WITH GUARD

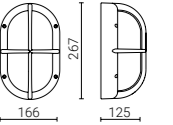

Code	
9182	● GR - graphite ○ BI - white
9184*	
8110	
8190*	

*Diffusore in policarbonato antivandalo IK10 / IK10 vandalproof polycarbonate diffuser
Modulo LED a tensione di rete, compatibile con dimmer a taglio di fase / Mains voltage LED module, compatible with most phase-cut dimmers
E27 L max 173 mm (fornite senza lampadina / supplied without lamp)

Lamp	W	Lm LED	Real Lm	Optic
LED	10	1100	470	diffuse
E27	100	-	-	
	60	-	-	

Su richiesta / On request
2700K (code + 27K)
● AG - aluminium grey

KASKO OVALE CON PALPEBRA / OVAL WITH EYELID

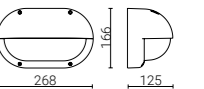

Code	
9186	● GR - graphite ○ BI - white
9187*	
8810	
8890*	

*Diffusore in policarbonato antivandalo IK10 / IK10 vandalproof polycarbonate diffuser
Modulo LED a tensione di rete, compatibile con dimmer a taglio di fase / Mains voltage LED module, compatible with most phase-cut dimmers
E27 L max 173 mm (fornite senza lampadina / supplied without lamp)

Lamp	W	Lm LED	Real Lm	Optic
LED	10	1100	234	diffuse
E27	100	-	-	
	60	-	-	

Su richiesta / On request
2700K (code + 27K)
● AG - aluminium grey

PLAFONIERE DA
PARETE O SOFFITTO

WALL OR CEILING
FITTINGS

JACK



Il corpo lampada JACK, tondo o ovale, è costituito da un apparecchio a tenuta stagna che contiene la base, la sorgente luminosa, il cablaggio, il diffusore e la cornice di chiusura. Il look finale si crea con le maschere, inserite semplicemente con un sistema a scatto, disponibili in forme e colori diversi. Le versioni LED offrono specifiche funzioni aggiuntive per l'illuminazione d'emergenza, temporizzata, notturna o con rilevatore incorporato. Così JACK offre una gamma di soluzioni versatile per l'illuminazione di spazi comuni e privati: luce scale, scantinati, corridoi, balconi, esterni e giardini.

The JACK lamp body, round or oval, consists of a watertight luminaire that contains the base, the light source, the wiring, the diffuser and the closing frame - the final look is created with the masks, simply applied with a snap-on system, available in different shapes and colors. The LED versions offer specific additional functions for emergency, timing, daylight and motion sensor. Thus JACK offers a range of versatile solutions for the lighting of common and private spaces: staircase, basements, corridors, balconies, exteriors and gardens.

WALL OR CEILING



JACK
round



JACK
oval

JACK

Struttura

La serie JACK è composta da:

- **corpi lampada** in policarbonato con trattamento anti UV, in forma tonda o ovale, con diffusore opale in vetro stampato o in policarbonato
- **maschere intercambiabili** in policarbonato con inserimento a scatto

Structure

The JACK range is composed of:

- **light bodies**, round or oval, in UV resistant polycarbonate with opal diffuser in moulded glass or polycarbonate
- **snap covering masks** in polycarbonate

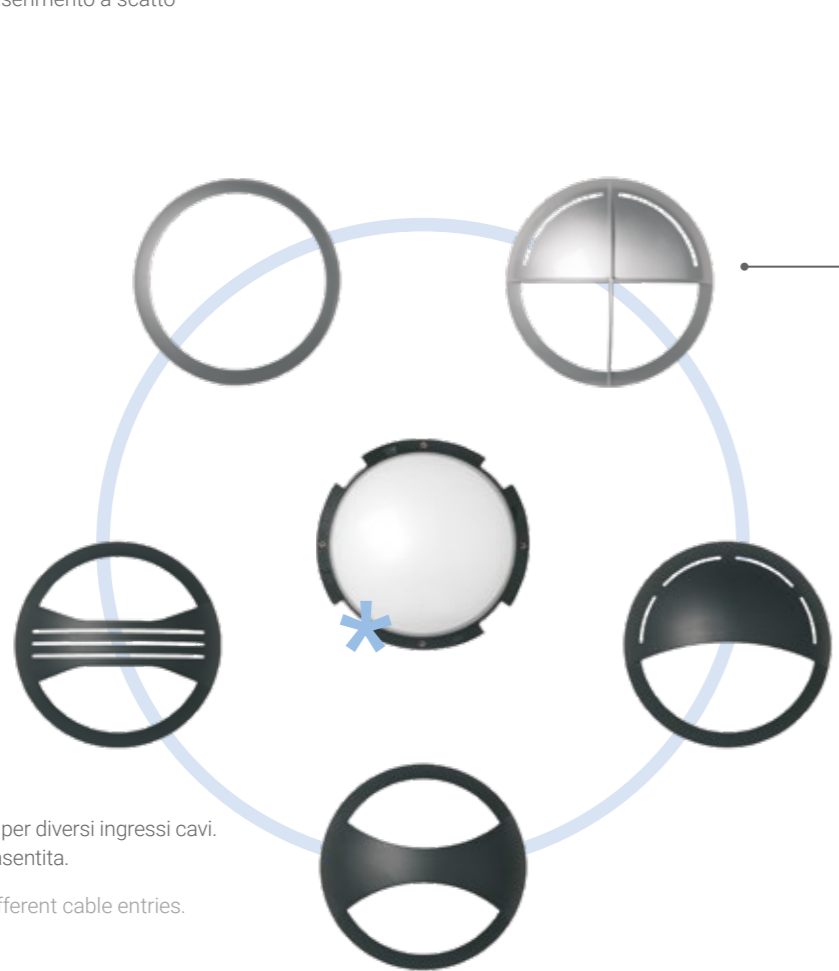

L'apparecchio è predisposto per diversi ingressi cavi. Alimentazione passante consentita.

The fixture is suitable for different cable entries. Through wiring allowed.

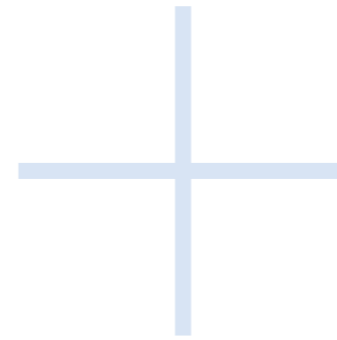

Massima componibilità

Il look finale si ottiene rivestendo il corpo lampada con apposite "maschere", disponibili in forme e colori diversi, installabili con un semplice scatto, atte a nascondere e proteggere le viti. La lampada assume così, volta per volta, una sua propria personalità.

Maximum modularity

The final look can be achieved changing the snap covering masks, in different shapes and colours, suitable to hide and protect the screws. The luminaire will achieve different personalities.

JACK STANDARD

Funzionamento ON / OFF.
ON / OFF operating.

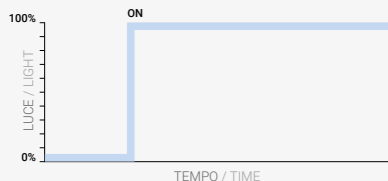

JACK STANDARD + EMERGENCY 3h

Funzionamento standard ON / OFF con innesto automatico dell'emergenza in caso di black-out.

Standard ON / OFF operating with automatic emergency ignition in case of black-out.

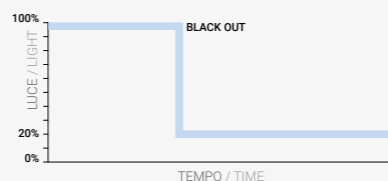

JACK INTELLIGENT ILLUMINATION

Rilevatore di presenza: accensione al 100% al passaggio.
Dimmer: regolazione luce notturna 0-30%.
Settaggi: area di rilevamento, timer, crepuscolare.
Motion sensor: 100% ignition upon detection.
Dimmer: night light adjustment 0-30%.
Settings: detection area, timing, daylight.

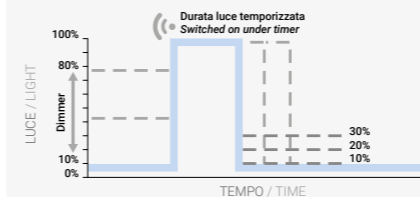
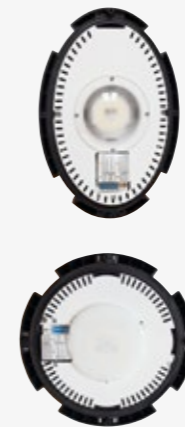

JACK INTELLIGENT ILLUMINATION + EMERGENCY 3h

Combinazione funzionamento con rilevatore di presenza crepuscolare + emergenza al black-out.

Combination of motion sensor + emergency functions.

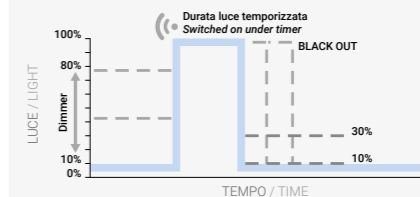

JACK

Parete o soffitto / Wall or ceiling



CORPI LAMPADA / LIGHT BODIES

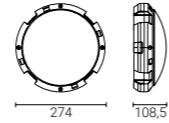

Code	Lamp	W	Lm LED	Real Lm	Optic
2101	LED	15	1575	645	diffuse
2191*	LED + 3h emergency	15	1575/240	645/119	
4451	LED + intelligent illumination	15	1575	645	
4453*	LED + intelligent illumination + 3h emergency	15	1575/240	645/119	
2105	● NE - black	-	-	-	-
2195*					
4301					
4302*					
2201					
2291*	E27	75	-	-	-

*Diffusore in policarbonato antivandalo IK10 / IK10 vandalproof polycarbonate diffuser [Su richiesta / On request](#)
 Modulo LED a tensione di rete, compatibile con dimmer a taglio di fase / Mains voltage LED module, compatible with most phase-cut dimmers
 E27 L max 145 mm (forniti senza lampadina / supplied without lamp)

MASCHERE / MASKS



code 2213

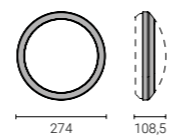

code 2213



code 2214



code 2215



code 2216



code 2217

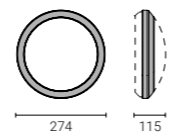

codes
2214 2215 2216 2217

Code	Description
2213	Maschera di rivestimento in policarbonato, bloccaggio a scatto senza viti / Covering mask in polycarbonate, screwless snap fixing
2214	
2215	
2216	
2217	

[Su richiesta / On request](#)
 2213 ○ BI - white

JACK

Parete o soffitto / Wall or ceiling



CORPI LAMPADA / LIGHT BODIES

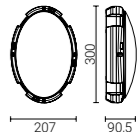

Code	Lamp	W	Lm LED	Real Lm	Optic
2143	LED	10	1100	592	diffuse
2146	LED + intelligent illumination	10	1100	592	
2241	E27	60	-	-	

Modulo LED a tensione di rete, compatibile con dimmer a taglio di fase / Mains voltage LED module, compatible with most phase-cut dimmers
 E27 L max 173 mm (forniti senza lampadina / supplied without lamp)

MASCHERE / MASKS



code 2263



code 2264

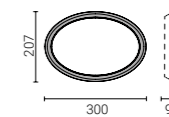

code 2263

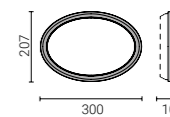

code 2264



code 2265



code 2267

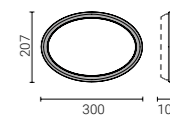

codes 2265 2267

Code	Description
2263	Maschera di rivestimento in policarbonato, bloccaggio a scatto senza viti / Covering mask in polycarbonate, screwless snap fixing
2264	
2265	
2267	

[Su richiesta / On request](#)
 2263 ○ BI - white

PLAFONIERE DA
PARETE O SOFFITTO

WALL OR CEILING
FITTINGS

MARINA



MARINA è un classico di Goccia Illuminazione. Mantenendo lo stile storico e versatile della linea, si caratterizza nella versione attuale con una protezione IP65, con una finitura grafite che conferisce una moderna reinterpretazione e completa resistenza ai raggi UV, con un cablaggio interno anche per cavi ad alta resistenza termica e con i diffusori in vetro o in policarbonato antivandalo. Il modello MAGNUM, grazie al diametro di 350 mm, è indicato per l'installazione a soffitto e quando è richiesta un'illuminazione forte e diffusa.

MARINA is a classic of Goccia Illuminazione. Maintaining the traditional and versatile style of the line, it is characterized in the current version with an IP65 protection, with a graphite finish that gives a modern reinterpretation and complete resistance to UV rays, with an internal wiring also for high thermal resistance cables and with diffusers in glass or vandal-proof polycarbonate. The MAGNUM model is suitable for ceiling installation and when strong and widespread lighting is required, thanks to its diameter of 350 mm.

WALL OR CEILING



MARINA
oval



MARINA
oval with guard



PALPEBRA



MARINA
round



MARINA
round with guard



MAGNUM

Struttura

Diffusore opale in vetro o policarbonato antivandalo. Corpo, anello, griglia e palpebra in policarbonato verniciato con trattamento anti UV. Riflettore in alluminio 99,8 brillantato e precablato.

Structure

Opal diffuser in glass or vandalproof polycarbonate. Body, ring, guard and eyelid in painted polycarbonate with UV resistant treatment. 99,8 polished and pre-wired aluminium reflector.



Ingresso cavi possibile da ogni parte

- dall'alto con doppia sicurezza
- laterale
- dal basso
- entra ed esci
- dal retro per punto-luce a parete o a soffitto

Cable entry from any side

- from the top with double security
- from the side
- from the bottom
- through wiring
- from the rear for wall or ceiling installation

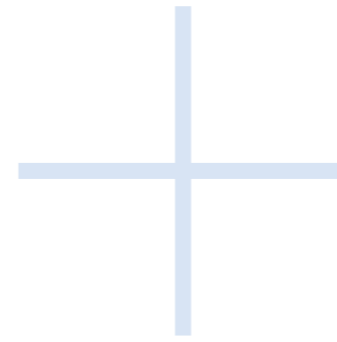

IP 65 e cablaggio facilitato

Ingresso cavi dal retro o laterale mediante il pressacavo fornito o giunto chiudi guaina o giunto tubo-scatola.

IP 65 and easy connection

Cable entry from either the rear or the side through the supplied cable gland or flexible conduit or rigid conduit adaptor.



MARINA

Parete o soffitto / Wall or ceiling



MARINA OVALE / OVAL



L 200 mm

L 270 mm

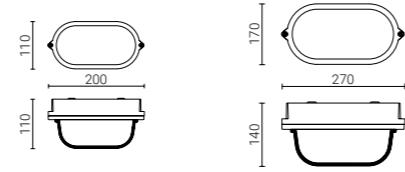

Code	L	Lamp	W	Lm LED	Real Lm	Optic
4560	200 mm	E27	60	-	-	diffuse
4580	270 mm		100			
4592*			75			

*Diffusore in policarbonato antivandalo IK10 / IK10 vandalproof polycarbonate diffuser

4560 E27 L max 117 mm (fornita senza lampadina / supplied without lamp)

4580, 4592 E27 L max 173 mm (fornite senza lampadina / supplied without lamp)



MARINA

Parete o soffitto / Wall or ceiling



MARINA OVALE CON GRIGLIA / OVAL WITH GUARD



L 200 mm

L 270 mm

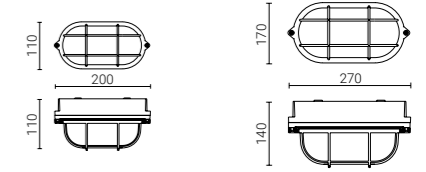

Code	L	Lamp	W	Lm LED	Real Lm	Optic
4510	200 mm	E27	60	-	-	diffuse
4520	270 mm		100			
4590*			75			

*Diffusore in policarbonato antivandalo IK10 / IK10 vandalproof polycarbonate diffuser

4510 E27 L max 117 mm (fornita senza lampadina / supplied without lamp)

4520, 4590 E27 L max 173 mm (fornite senza lampadina / supplied without lamp)

PALPEBRA



L 200 mm

L 270 mm



Code	L	Lamp	W	Lm LED	Real Lm	Optic
2806	200 mm	E27	60	-	-	diffuse
2825	270 mm		100			
2895*			75			

*Diffusore in policarbonato antivandalo IK10 / IK10 vandalproof polycarbonate diffuser

2806 E27 L max 117 mm (fornita senza lampadina / supplied without lamp)

2825, 2895 E27 L max 173 mm (fornite senza lampadina / supplied without lamp)

MARINA

Parete o soffitto / Wall or ceiling



MARINA TONDA / ROUND

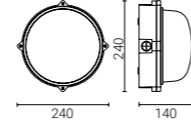

Code		Ø	Lamp	W	Lm LED	Real Lm	Optic
4780	● GR - graphite	240 mm	E27	100	-	-	diffuse
4792*	○ BI - white			75			

*Diffusore in policarbonato antivandalo IK10 / IK10 vandalproof polycarbonate diffuser

E27 L max 145 mm (fornite senza lampadina / supplied without lamp)

MARINA

Parete o soffitto / Wall or ceiling



MAGNUM

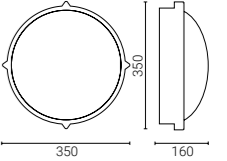

Code		Ø	Lamp	W	Lm LED	Real Lm	Optic
2481	● GR - graphite	350 mm	LED	25	3300	1528	diffuse
2495	○ BI - white			2x60			

Diffusore in policarbonato antivandalo IK10 / IK10 vandalproof polycarbonate diffuser

E27 L max 173 mm (fornita senza lampadina / supplied without lamp)

MARINA TONDA CON GRIGLIA / ROUND WITH GUARD

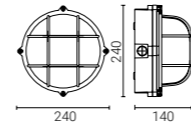

Code		Ø	Lamp	W	Lm LED	Real Lm	Optic
4720	● GR - graphite	240 mm	E27	100	-	-	diffuse
4790*	○ BI - white			75			

*Diffusore in policarbonato antivandalo IK10 / IK10 vandalproof polycarbonate diffuser

E27 L max 145 mm (fornite senza lampadina / supplied without lamp)



RGBW



Il sistema RGBW di Goccia Illuminazione, comandato da centralina remota tramite un segnale trasmesso con protocollo DMX 512 Standard, permette di programmare i LED RGB e miscelare i colori e la luce bianca, secondo il metodo rosso, verde, blu + bianco. La gamma RGBW è composta dalle serie CLOCK, K³ e PASSUM UP, dotate del dispositivo per la ricezione del segnale, e dal generatore remoto per la gestione delle varie funzioni.

RGBW di Goccia Illuminazione è un applicativo da esterno di qualità per tutte le installazioni in cui l'effetto cromatico luminoso vada ad esaltare l'architettura e le strutture.

The RGBW system by Goccia Illuminazione, controlled by a remote control unit through a signal transmitted with the DMX 512 Standard protocol, allows to program the RGB LEDs and mix the colors and white light, according to the red, green, blue + white method. The RGBW range consists of the CLOCK, K³ and PASSUM UP series, equipped with the device to receive the signal, and of the remote generator to manage the various functions.

RGBW by Goccia Illuminazione is a quality outdoor application for all installations in which the luminous chromatic effect enhances the architecture and structures.

GROUND OR WALL RECESSED



RGBW PASSUM UP
Ø 125



RGBW PASSUM UP
Ø 180



RGBW PASSUM UP
Ø 245

SPOTLIGHT



RGBW CLOCK
Ø 80



RGBW CLOCK
Ø 120

WALL EFFECTS



RGBW K³
1 window



RGBW K³
2 windows

RGBW

Sistema RGBW

Il sistema RGBW di Goccia Illuminazione, comandato da centralina remota attraverso un segnale trasmesso con protocollo DMX 512 Standard, è composto dagli apparecchi CLOCK, K³ e PASSUM UP dotati di dispositivo per ricevere il segnale. Il generatore di segnale DMX è fornito comprensivo di scatola da incasso e consente la regolazione di tutti gli apparecchi.

RGBW System

The RGBW system by Goccia Illuminazione, controlled by the remote unit through a signal transmitted via Standard DMX 512 protocol, is composed of CLOCK, K³ and PASSUM UP fittings equipped with a device for signal receipt. DMX signal generator is supplied with its backbox and allows the user to regulate all fittings.



* Funzioni: scelta del colore, dimmerazione dell'intensità di luce, rotazione dei colori e passaggio al bianco puro.
 Functions: choice of the colour, dimming of the light intensity, colour rotation and transition to pure white.

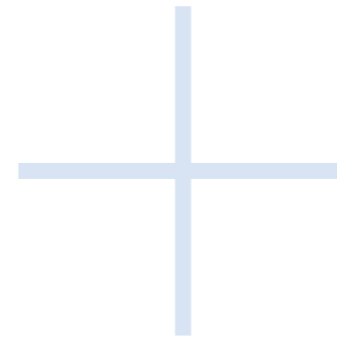

Ampia gamma fasci e colori

Grazie alle lenti ad elevate prestazioni sono disponibili 3 aperture del fascio per ogni soluzione: 10°- 30°- 54°. È possibile ottenere una vastissima gamma di colori oltre alla possibilità di dimmerazione.

Wide range of beams and colours

Thanks to the high efficiency lenses, 3 beam angles are available for each version: 10°- 30°- 54°. You can get a wide range of colours and dim the light.

230V SISTEMA DI CABLAGGIO / WIRING SYSTEM

Le serie K³ e PASSUM UP Ø 245 presentano soluzioni con alimentatore 230V a bordo controllabili dalla centralina.

The ranges K³ and PASSUM UP Ø 245 come with 230V built-in driver versions controlled by the unit.

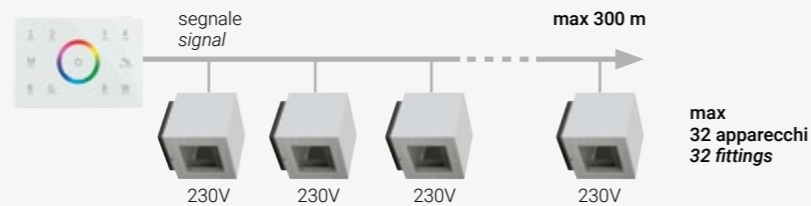

24V SISTEMA DI CABLAGGIO / WIRING SYSTEM

Le serie CLOCK, PASSUM UP Ø 125 e PASSUM UP Ø 180 presentano soluzioni a 24V, controllabili in remoto da appositi reattori 24V e dalla centralina.

The ranges CLOCK, PASSUM UP Ø 125 and PASSUM UP Ø 180 come with 24V versions controlled by the unit. Dedicated 24V remote drivers available.

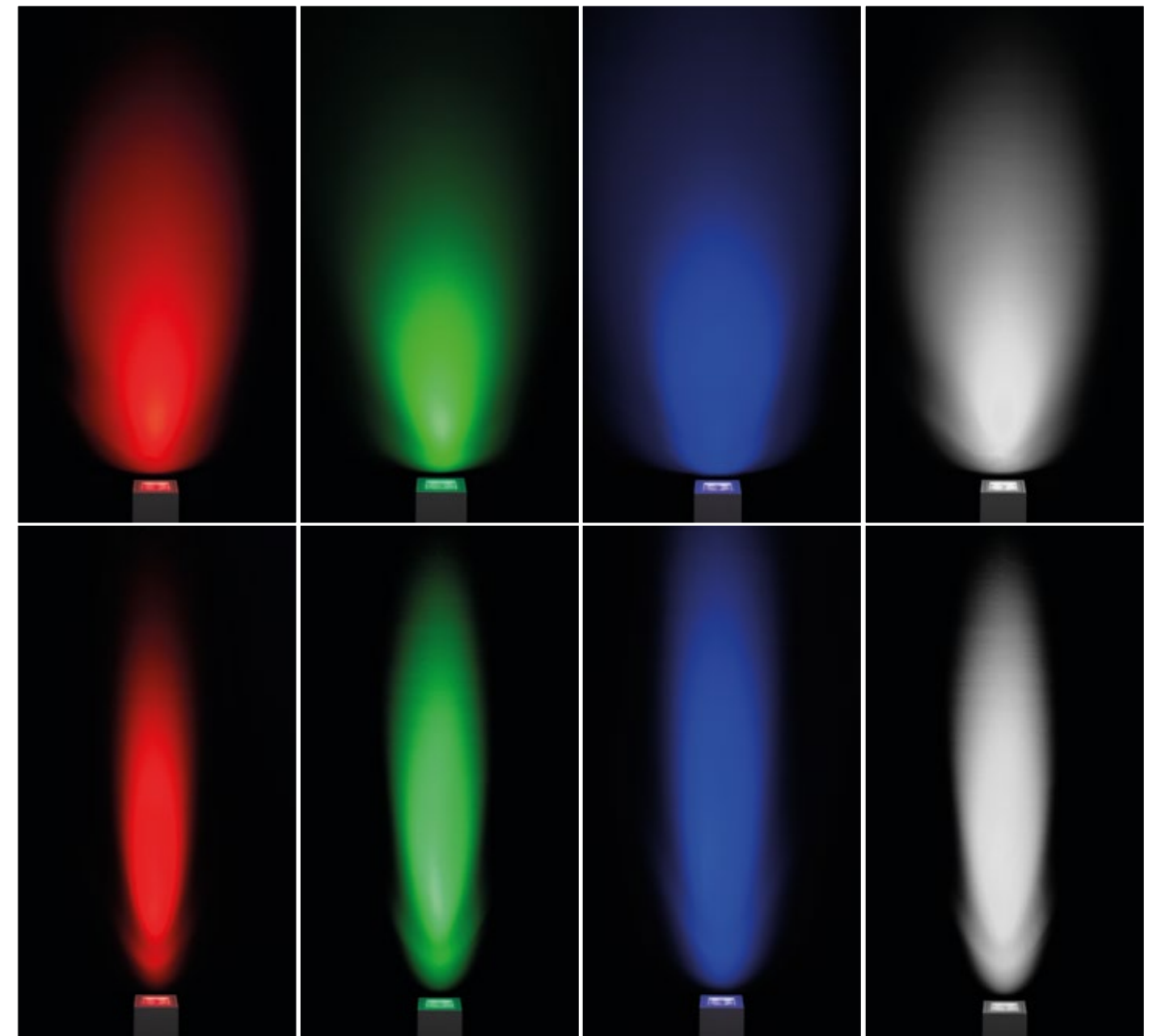
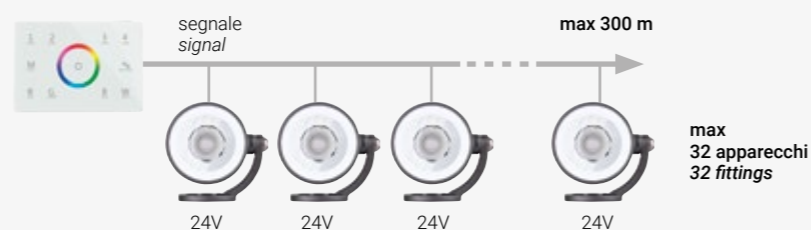

RGBW PASSUM UP

Incasso a terra o parete / Ground or wall recessed



CORPO LAMPADA / LIGHT BODY Ø 125 mm

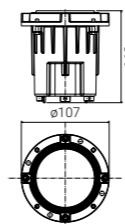

Code	Material	Lamp	W	Lm LED	Real Lm	Optic
1462	aluminium	LED RGBW	12 max	330 max	230 max	30°

Ottiche opzionali / Optional optics 10° (code + 10), 54° (code + 54)

Contiene 1 LED RGBW e dispositivo per ricevere il segnale DMX standard 512 inviato da centralina cod. 1181 o altra centralina compatibile / It contains 1 RGBW LED and a device to receive DMX standard 512 signal sent from the control unit code 1181 or another compatible unit

Fornito con 0,5 m di cavo: segnale + alimentazione a 24V / Supplied with 0,5 m cable: signal + 24V

Driver esterno non compreso / Remote driver to be ordered separately (page 325)

IP 67 con flange / IP 67 with flanges

Flangia di chiusura e cassaforma non comprese / Covering flange and in-ground box not included (pages 28-29)

[Su richiesta / On request](#)

Settaggio multicanale degli apparecchi / Multi-channel setting of the fittings

RGBW PASSUM UP

Incasso a terra / Ground recessed



CORPO LAMPADA / LIGHT BODY Ø 245 mm

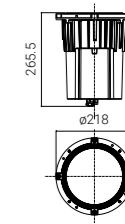

Code	Material	Lamp	W	Lm LED	Real Lm	Optic
1482	aluminium	LED RGBW	32 max	990 max	690 max	30°

Ottiche opzionali / Optional optics 10° (code + 10), 54° (code + 54)

Contiene 3 LED RGBW e dispositivo per ricevere il segnale DMX standard 512 inviato da centralina cod. 1181 o altra centralina compatibile / It contains 3 RGBW LEDs and a device to receive DMX standard 512 signal sent from the control unit code 1181 or another compatible unit

Fornito con 2 cavi da 0,5 m: segnale + alimentazione a 230V / Supplied with two 0,5 m cables: signal + 230V

IP 67 con flange / IP 67 with flanges

Flangia di chiusura e cassaforma non comprese / Covering flange and in-ground box not included (page 33)

[Su richiesta / On request](#)

Settaggio multicanale degli apparecchi / Multi-channel setting of the fittings

CORPO LAMPADA / LIGHT BODY Ø 180 mm

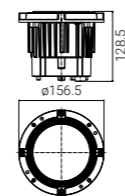

Code	Material	Lamp	W	Lm LED	Real Lm	Optic
1464	aluminium	LED RGBW	25 max	990 max	690 max	30°

Ottiche opzionali / Optional optics 10° (code + 10), 54° (code + 54)

Contiene 3 LED RGBW e dispositivo per ricevere il segnale DMX standard 512 inviato da centralina cod. 1181 o altra centralina compatibile / It contains 3 RGBW LEDs and a device to receive DMX standard 512 signal sent from the control unit code 1181 or another compatible unit

Fornito con 0,5 m di cavo: segnale + alimentazione a 24V / Supplied with 0,5 m cable: signal + 24V

Driver esterno non compreso / Remote driver to be ordered separately (page 325)

IP 67 con flange / IP 67 with flanges

Flangia di chiusura e cassaforma non comprese / Covering flange and in-ground box not included (pages 30-31)

[Su richiesta / On request](#)

Settaggio multicanale degli apparecchi / Multi-channel setting of the fittings

RGBW CLOCK

Spot / Spotlight



RGBW CLOCK Ø 80 mm

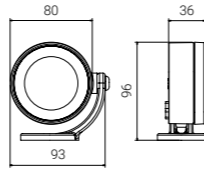

Code	
1186	<ul style="list-style-type: none"> AN - anthracite AG - aluminium grey VE - green

Lamp	W	Lm LED	Real Lm	Optic
LED RGBW	12 max	330 max	230 max	30°

Ottiche opzionali / Optional optics 10° (code + 10), 54° (code + 54)

Contiene 1 LED RGBW e dispositivo per ricevere il segnale DMX standard 512 inviato da centralina cod. 1181 o altra centralina compatibile / It contains 1 RGBW LED and a device to receive DMX standard 512 signal sent from the control unit code 1181 or another compatible unit

Fornito con 0,5 m di cavo: segnale + alimentazione a 24V / Supplied with 0,5 m cable: signal + 24V

Driver esterno non compreso / Remote driver to be ordered separately (page 325)

Accessori opzionali: vedi capitolo CLOCK / Optional accessories: see chapter CLOCK (pages 108-114)

Su richiesta / On request

Settaggio multicanale degli apparecchi / Multi-channel setting of the fittings
 BI - white CO - corten GR - graphite GM - metallized grey

RGBW K³

Effetti a parete / Wall effects

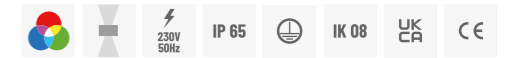

RGBW K³

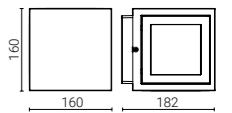

Code	
1184	<ul style="list-style-type: none"> AN - anthracite AG - aluminium grey
1185	<ul style="list-style-type: none"> <input type="radio"/> BI - white

Material	Lamp	W	Lm LED	Real Lm	Optic
aluminium	LED RGBW	1x32 max	990 max	690 max	1x30°
		2x32 max	1980 max	1380 max	2x30°

Ottiche opzionali / Optional optics 10° (code + 10), 54° (code + 54)

Contiene 3 LED RGBW ogni faccia e dispositivo per ricevere il segnale DMX standard 512 inviato da centralina cod. 1181 o altra centralina compatibile / It contains 3 RGBW LEDs each window and a device to receive DMX standard 512 signal sent from the control unit code 1181 or another compatible unit

Su richiesta / On request

Settaggio multicanale degli apparecchi / Multi-channel setting of the fittings
 GR - graphite GM - metallized grey

RGBW CLOCK Ø 120 mm

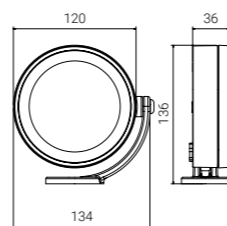

Code	
1187	<ul style="list-style-type: none"> AN - anthracite AG - aluminium grey VE - green

Lamp	W	Lm LED	Real Lm	Optic
LED RGBW	25 max	990 max	690 max	30°

Ottiche opzionali / Optional optics 10° (code + 10), 54° (code + 54)

Contiene 3 LED RGBW e dispositivo per ricevere il segnale DMX standard 512 inviato da centralina cod. 1181 o altra centralina compatibile / It contains 3 RGBW LEDs and a device to receive DMX standard 512 signal sent from the control unit code 1181 or another compatible unit

Fornito con 0,5 m di cavo: segnale + alimentazione a 24V / Supplied with 0,5 m cable: signal + 24V

Driver esterno non compreso / Remote driver to be ordered separately (page 325)

Accessori opzionali: vedi capitolo CLOCK / Optional accessories: see chapter CLOCK (pages 108-114)

Su richiesta / On request

Settaggio multicanale degli apparecchi / Multi-channel setting of the fittings
 BI - white CO - corten GR - graphite GM - metallized grey

RGBW

Accessori / Accessories

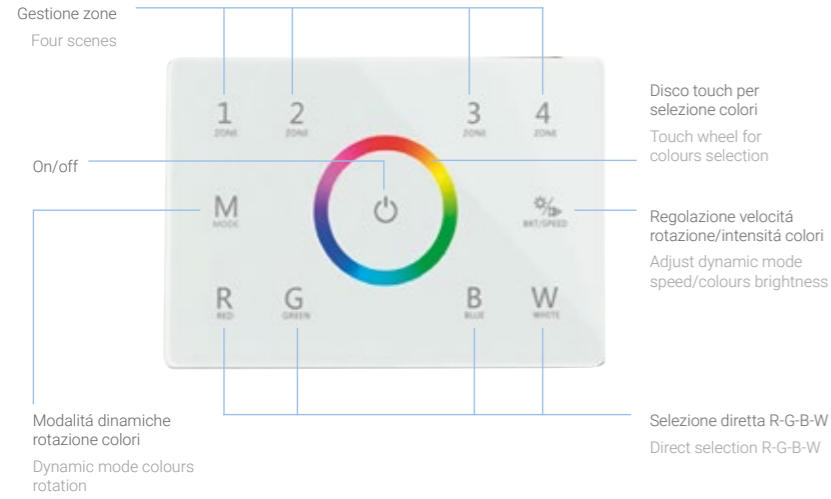

Generatore di segnale DMX 512 Standard con comandi touch screen per pilotare il sistema RGBW degli apparecchi Goccia Illuminazione. Emissione segnale fino alla distanza max di 300 m per un max di n° 32 apparecchi collegati con appropriato cavo per DMX. Per distanze superiori il segnale va amplificato con adeguato ripetitore/ amplificatore di segnale DMX Standard 512.

Touch screen DMX 512 standard signal generator capable to drive the fittings to the system RGBW. Max. of 32 fittings until 300 m with the appropriate DMX cable. For longer distances or signal missing use a relevant signal amplifier.

RGBW

Accessori / Accessories



ALIMENTATORI 24V DC / 24V DC CONTROL GEARS

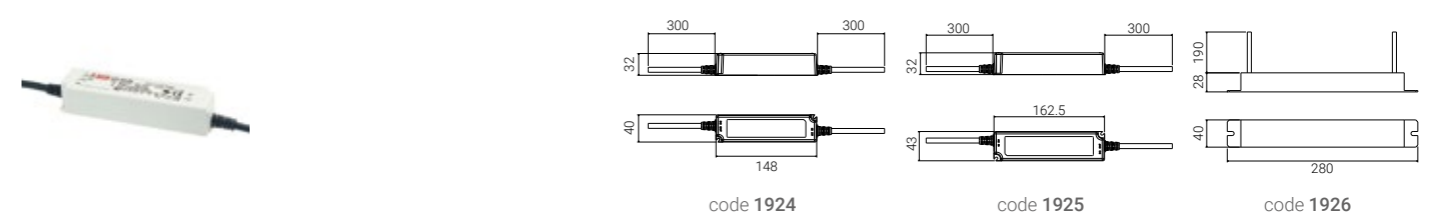

Code	W	Description
1924	25	INPUT 220-240 V - OUTPUT 24V DC
1925	60	
1926	150	

RGBW CENTRALINA / RGBW SIGNAL GENERATOR

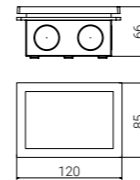

Code	Description
1181	Centralina 230V compatibile con gli apparecchi RGBW, completa di scatola per incasso a muro / Signal generator 230V suitable for RGBW fittings, complete with its backbox to recess in the wall

Su richiesta / On request

Telecomando e apposito convertitore compatibili con gli apparecchi RGBW / Remote controller and related converter compatible with RGBW fittings
 Settaggio multicanale degli apparecchi / Multi-channel setting of the fittings

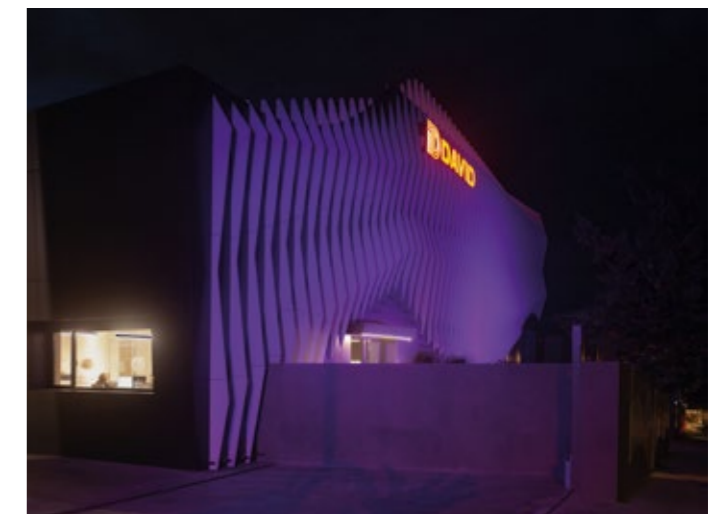

ACCESSORI

ACCESSORIES

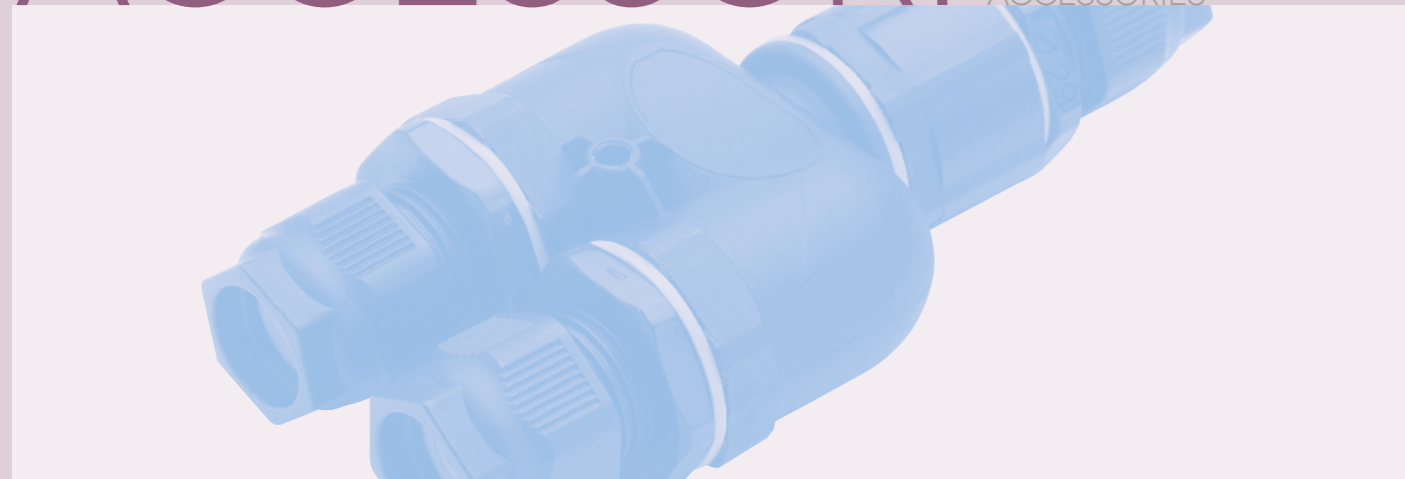

GIUNTI STAGNI / WATERPROOF CONNECTIONS

IP 68 UK CE



code 1941



code 1942



code 1941



code 1942



code 1943



code 1944



code 1943

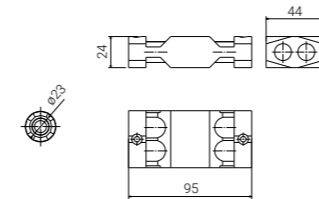

code 1944

Code	Description
1941	Connessione singola 3x2,5 mm ² IP68 / Single connector 3x2,5 mm ² IP 68
1942	Connessione entra-esci 3x2,5 mm ² IP68 / Through wiring connector 3x2,5 mm ² IP 68
1943	Connessione singola presa-spina 3x2,5 mm ² IP68 / Plug/socket connector 3x2,5 mm ² IP 68
1944	Connessione fino a 4 uscite 3x2,5 mm ² IP68 (basato su gel siliconico bicomponente) / Up to 4 outputs connector 3x2,5 mm ² IP 68, based on two-component silicone gel

ACCESSORI ACCESSORIES

ALIMENTATORI 24V DC / 24V DC CONTROL GEARS

24V DC IP 67 UK CE

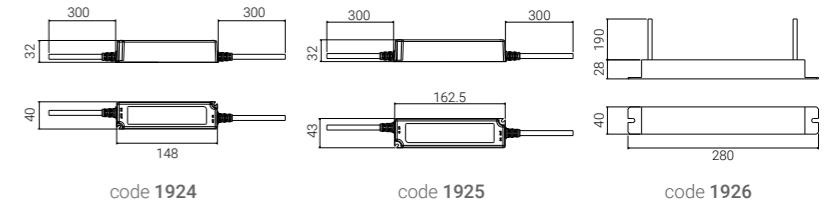

Code	W	Description
1924	25	INPUT 220-240 V - OUTPUT 24V DC
1925	60	
1926	150	

DRIVER DALI

IP 20 UK CE



Code	Description
1956	INPUT 220-240 V o 110-127 V / AC o DC - OUTPUT 350 mA (17W) / 700 mA (32W)
1957	INPUT 220-240 V o 110-127 V / AC o DC - OUTPUT 350 mA (39W) / 700 mA (60W)

PROTETTORI DI SOVRATENSIONI / SURGE PROTECTION DEVICES (SPD)

UK CE



code 1965



code 1966

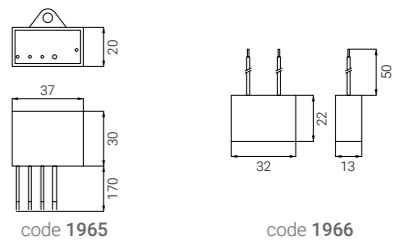

Code	Description
1965	SPD type 2+3 Class I 10kV IP67
1966	SPD type 3 Class II 10kV

Da installare ad una distanza max 10 m per proteggere da disturbi di rete /
To be installed at max 10 m distance to protect against overvoltage

INFORMAZIONI GENERALI

GENERAL INFORMATION

COME LEGGERE IL CATALOGO
HOW TO READ THE CATALOGUE

Applicazione / Application

INCASSI A TERRA, A PARETE E DOWNLIGHT

GROUND OR WALL RECESSED AND DOWNLIGHT

PASSUM

Descrizione / Description

PASSUM è la famiglia di apparecchi da incasso per esterni ad alte prestazioni, con massima tecnologia di illuminazione e straordinaria flessibilità e precisione nell'installazione. Contraddistinta da solidità, perfetta tenuta stagna, resistenza alla corrosione, si articola nelle diverse versioni in alluminio o acciaio inox AISI 316L.

PASSUM UP è la scelta per l'illuminazione da incasso verso l'alto, modulare e componibile secondo le esigenze, dispone inoltre di una versione ad altezza d'installazione minimizzata - ultraflat.

PASSUM SIDEWARDS è la serie per l'illuminazione radente laterale da incasso su percorsi e pavimentazioni. Le alte prestazioni delle unità LED sono ottimizzate dalle ottiche con tecnologia per l'emissione laterale - side emitter.

PASSUM SPOT rappresenta l'applicazione più innovativa della famiglia, grazie ai performanti LED e alle ottiche orientabili che ne fanno un inedito proiettore da incasso a pavimento.

PASSUM DOWNLIGHT è la versione downlight da incasso a soffitto. Il sistema di ganco di fissaggio consente di montare le lampade precablate, grazie alla versione ultraflat anche in altezze limitate.

PASSUM is the family of high performance recessed luminaires for outdoor use, with maximum lighting technology and extraordinary flexibility and precision in installation. Characterized by solidity, perfect watertightness, resistance to corrosion, it is divided into different versions in aluminum or AISI 316L stainless steel.

PASSUM UP is the choice for upward recessed lighting, modular and adaptable according to all needs, it also has a version with minimized installation height - ultraflat.

PASSUM SIDEWARDS is the series for recessed side grazing lighting on paths and pavements. The high performance of the LED units is optimized by the optics with side emitter technology.

PASSUM SPOT represents the most innovative application of the family, thanks to the high-performance LEDs and the adjustable optics that make it a brand new recessed floor projector.

PASSUM DOWNLIGHT is the recessed ceiling downlight version. The fixing hook system allows pre-wired lamps to be mounted, thanks to the ultraflat version even in limited heights.

GROUND OR WALL RECESSED

CEILING RECESSED

Nome serie / Series name

Gamma prodotti / Product range

22

goccia
ILLUMINAZIONE

catalogue 2023

23

Nome prodotto / Product name

INCASSO A TERRA O PARETE / Ground or wall recessed

Icone / Icons

Applicazione / Application

Disegno quotato / Dimensioned drawing

PASSUM UP

INCASSO A TERRA O PARETE BASSO SPESSORE / Ground or wall recessed low depth

CORPI LAMPADA / LIGHT BODIES Ø 70 mm

Code	Material	Lamp	W	Len LED	Real Lm	Optic
1412	aluminum	LED	1	155	88	30°
1413			3	300	162	
1491	AISI 316L stainless steel	LED	1	155	88	30°
1494			3	300	162	

Ottiche opzionali / Optional optics 18" (code + 18), 90" (code + 90)

Driver esterno non compreso / Remote driver to be ordered separately (page 30)

IP 67 con flange / IP 67 with flanges

Su richiesta / On request

2700K (code + 27K)

Lunghezza cavo 7 m / 7 m cable length (code + MT7)

CASSAFORMA / IN-GROUND BOX Ø 70 mm

Code	Description
1411	Cassaforma Ø 70 in tecnopolimero da interrato o da parete / In-ground box Ø 70 mm in technopolymer

FLANGE / FLANGES 70 mm

Code	Description
1511	Flangia tonda Ø 70 in alluminio / Round flange Ø 70 in aluminum
1512	Flangia tonda Ø 70 in acciaio inox AISI 316L / Round flange Ø 70 in AISI 316L stainless steel
1513	Flangia quadrata 70x70 in acciaio inox AISI 316L / Square flange 70x70 in AISI 316L st. steel

Su richiesta / On request

L'insieme corpo lampada+flangia viene fornito montato, sigillato e orientato / The set light body+flange can be supplied assembled, sealed and oriented

GM - metallized grey

Informazioni tecniche / Technical information

CORPO LAMPADA / LIGHT BODY Ø 125 mm ULTRAFLAT

Code	Material	Lamp	W	Len LED	Real Lm	Optic
1401	aluminum	LED	8	800	347	diffuse
4K-4000K						

Modulo LED a tensione di rete, compatibile con dimmer a taglio di fase / Main voltage LED module, compatible with most phase-cut dimmers

IP 67 con flange / IP 67 with flanges

Su richiesta / On request

2700K (code + 27K)

12-24V low voltage

CASSAFORMA / IN-GROUND BOX Ø 125 mm ULTRAFLAT

Code	Description
1423	Cassaforma ultraflat Ø 125 mm con profondità di incasso molto contenuta in tecnopolimero / Ultraflat in-ground box Ø 125 mm in technopolymer

FLANGE / FLANGES 125 mm

Code	Description
1521	Flangia tonda Ø 125 in alluminio / Round flange Ø 125 in aluminum
1522	Flangia tonda Ø 125 in acciaio inox AISI 316L / Round flange Ø 125 in AISI 316L stainless steel
1523	Flangia quadrata 125 x 125 in acciaio inox AISI 316L / Square flange 125 x 125 in AISI 316L st. steel

Su richiesta / On request

L'insieme corpo lampada+flangia viene fornito montato, sigillato e orientato / The set light body+flange can be supplied assembled, sealed and oriented

GM - metallized grey

Note / Notes

Codice prodotto / Product code

* Il codice prodotto è composto da:
ARTICOLO + FINITURA + TONALITÀ + OTTICA
The product code is explained as follows:
ITEM + FINISH + TONALITY + OPTIC

4664 Articolo / Item

AN3K Finitura / Finish

12 Tonalità / Tonality

12 Ottica / Optic

26

goccia
ILLUMINAZIONE

catalogue 2023

27

CONFORMITÀ COMPLIANCES

CE

Questa marcatura è obbligatoria per la libera circolazione del prodotto nella Comunità Europea e costituisce a tutti gli effetti la dichiarazione da parte del fabbricante che il prodotto è conforme alle direttive (2014/35/UE - 2014/30/UE) e quindi costruito, verificato e collaudato in conformità alle norme (sicurezza e compatibilità EMC) applicabili. La Marcatura CE non comporta controllo o garanzia alcuna da parte di istituti di certificazione volontaria (Marchi di Qualità) / This mark is compulsory for the free trade of the products within the EEC. It represents in every respect the declaration of the manufacturer that the product is in accordance with the directives (2014/35/EU - 2014/30/EU) and therefore manufactured, checked and tested in compliance with the relevant rules (Safety and EMC Compatibility). The CE mark does not require any control or warranty by any voluntary certification institute (Quality Trade Mark)

UK
CA

La marcatura UKCA (UK Conformity Assessed) è il nuovo marchio di prodotto del Regno Unito che deve essere utilizzato per i prodotti immessi sul mercato in Gran Bretagna (Inghilterra, Galles e Scozia) a dimostrazione della conformità degli stessi alle normative tecniche in vigore in UK: UK SI 2016 No. 1101, UK SI 2016 No. 1091, UK SI 2010 No. 2617, UK SI 2012 No. 3032 / The UK Conformity Assessed (UKCA) mark is a mandatory mark used for products being placed on the market in Great Britain (England, Scotland and Wales) to indicate that they comply with the UK Standards: UK SI 2016 No. 1101, UK SI 2016 No. 1091, UK SI 2010 No. 2617, UK SI 2012 No. 3032.

Gli apparecchi di Goccia Illuminazione sono costruiti e testati secondo le Norme di seguito elencate, in dipendenza della loro tipologia / Goccia Illuminazione luminaires are built and tested according to the Standards listed below, depending on their typology

EN 60598-1	Norma generale - Prescrizioni generali e prove / General requirements and tests
EN 60598-2-13	Prescrizioni particolari - Apparecchi di illuminazione da incasso a terra / Particular requirements – Ground recessed luminaires
EN 60598-2-2	Prescrizioni particolari - Apparecchi di illuminazione da incasso / Particular requirements – Recessed luminaires
EN 60598-2-22	Prescrizioni particolari - Apparecchi di emergenza / Particular requirements – Luminaires for emergency lighting
EN 60598-2-1	Prescrizioni particolari - Apparecchi fissi per uso generale / Particular requirements - Fixed general purpose luminaires

RESISTENZA AGLI URTI IMPACT RESISTANCE

IK 08

Apparecchio protetto contro un'energia d'impatto di 5 Joule / Luminaire protected against an impact energy of 5 Joules

IK 10

Apparecchio protetto contro un'energia d'impatto di 20 Joule / Luminaire protected against an impact energy of 20 Joules

CLASSI DI ISOLAMENTO INSULATION CLASSES



Apparecchio dotato di isolamento di base. Protezione: collegamento delle parti metalliche accessibili alla terra di protezione. L'apparecchio richiede la messa a terra / Luminaire with basic insulation. Protection: connection of the accessible metal parts to the earthing protection. Earthing required



Apparecchio dotato di doppio isolamento. Protezione: mediante isolamento supplementare / Luminaire with double insulation. Protection: through additional insulation



Apparecchio idoneo per alimentazione a bassissima tensione di sicurezza. Protezione: intrinsecamente sicuro. Le parti che portano corrente possono essere accessibili / Luminaire suitable for supply at safety extra low voltage. Protection: intrinsically safe. The live parts can be accessed

CLASSIFICAZIONE IP IP RATING

IP 44

Apparecchio protetto contro la penetrazione di corpi solidi Ø > 1 mm e dagli spruzzi d'acqua / Luminaire protected against solid Ø > 1 mm and splashing water

IP 55

Apparecchio protetto contro la penetrazione della polvere e da getti d'acqua / Luminaire protected against powder and water jets

IP 65

Apparecchio a tenuta di polvere e protetto da getti di acqua / Dust-tight luminaire and protected against water jets

IP 66

Apparecchio a tenuta di polvere e protetto da ondate / Dust-tight luminaire and protected against powerful water jets

IP 67

Apparecchio a tenuta di polvere e protetto da immersione temporanea / Dust-tight luminaire and protected against temporary immersion

ICONE ICONS



24V DC



230V 50 Hz

CRI 80

Indice resa cromatica / Color rendering index



Carrabile, carico massimo: 2.000, 3.500 kg / Drive over, maximum load: 2.000, 3.500 kg



Calpestabile, carico massimo: 500, 1.000, 2.000 kg / Walk over, maximum load: 500, 1.000, 2.000 kg



Temperatura di contatto sul diffusore T≤40°C / Contact temperature on diffuser T≤40°C



Funzione Corridor / Corridor function



Illuminazione intelligente / Intelligent illumination



Illuminazione d'emergenza / Emergency lighting

ICONE
ICONS



Diffusore antivandalo / Vandalproof diffuser



Incasso a terra, calpestabile di superficie con ottica fissa /
Ground recessed, ground surface mounted with fixed optic



Incasso a terra con ottiche basculanti / Ground recessed with adjustable optics



Incasso a parete, lampada segnapasso, spot o a parete con ottica fissa /
Wall recessed, steplight, spotlight or wall mounted with fixed optic



Incasso a parete con ottiche basculanti / Wall recessed with adjustable optics



Incasso a soffitto, downlight o spot con ottica fissa /
Ceiling recessed, downlight or spotlight with fixed optic



Incasso a soffitto con ottiche basculanti / Ceiling recessed with adjustable optics



Palo, stelo, torretta multifunzione o arredo urbano /
Post, stem, garden power point or urban lighting



Effetti a parete / Wall effects



Apparecchio orientabile / Adjustable fitting



Apparecchio RGBW / RGBW fitting

FINITURE ALLUMINIO
ALUMINIUM FINISHES

NE - black

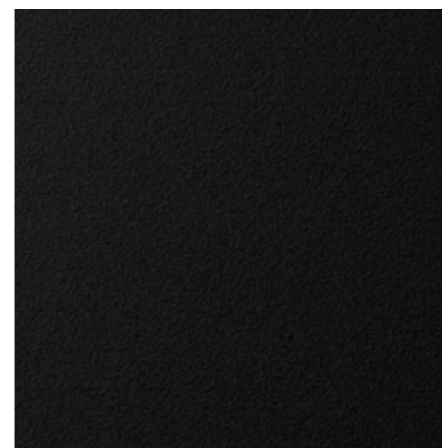

AN - anthracite



GR - graphite



AG - aluminium grey

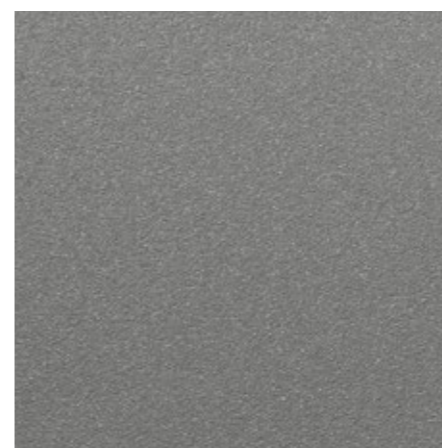

GM - metallized grey



BI - white

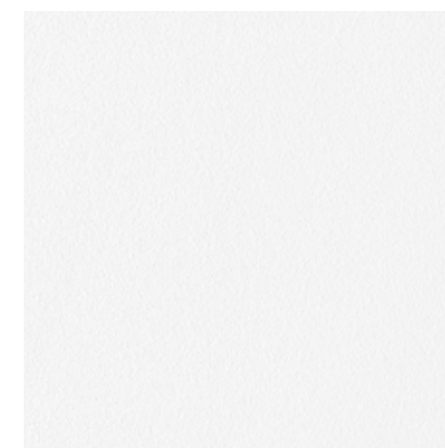

VE - green



CO - corten



BR - bronze



INDICE PER CODICE

INDEX BY CODE

Code	Series	Page
1004	K³ WRITER	229
1008	K³ WRITER	229
1014	K³ WRITER	229
1018	K³ WRITER	229
1022	K³ WRITER	229
1033	K³ WRITER	229
1040	K³ MINILED	224
1041	K³ MINILED	224
1042	K³ MINILED	224
1043	K³ MINILED	224
1044	K³ MINILED	224
1045	K³ MINILED	224
1046	K³ MINILED	224
1050	K³ MINILED	224
1051	K³ MINILED	224
1052	K³ MINILED	224
1053	K³ MINILED	224
1054	K³ MINILED	224
1055	K³ MINILED	224
1056	K³ MINILED	224
1087	LUX SHOWER	273
1090	K³ MINILED	225
1091	K³ WRITER	230
1092	K³ WRITER	230
1093	K³ WRITER	230
1095	K³ WRITER	230
1096	K³ WRITER	231
1102	K³ POWER	235
1105	K³ POWER	235
1106	K³ POWER	235
1109	K³ POWER	235
1112	K³ POWER	235
1115	K³ POWER	235
1116	K³ POWER	235
1119	K³ POWER	235

Code	Series	Page
1122	K³ POWER	235
1123	K³ POWER	235
1128	K³ POWER	235
1132	K³ POWER	235
1133	K³ POWER	235
1138	K³ POWER	235
1141	K³ POWER	235
1142	K³ POWER	235
1146	K³ POWER	235
1147	K³ POWER	235
1151	K³ POWER	235
1152	K³ POWER	235
1156	K³ POWER	235
1157	K³ POWER	235
1181	RGBW	324
1184	RGBW	323
1185	RGBW	323
1186	RGBW	322
1187	RGBW	322
1191	K³ POWER	236
1192	K³ POWER	236
1193	K³ POWER	236
1194	K³ POWER	237
1203	CORINTHIA	266
1204	CORINTHIA	266
1208	CORINTHIA	266
1213	CORINTHIA	266
1221	LUX SHOWER	272
1222	LUX SHOWER	272
1225	LUX SHOWER	273
1226	LUX SHOWER	273
1231	CORINTHIA	266
1232	CORINTHIA	266
1241	KYKLO	279
1242	KYKLO	279

Code	Series	Page
1301	WASH	216
1302	WASH	216
1305	WASH	216
1306	WASH	216
1308	WASH	216
1309	WASH	216
1311	WASH	218
1312	WASH	218
1321	WASH	217
1322	WASH	217
1324	WASH	217
1325	WASH	217
1327	WASH	217
1328	WASH	217
1332	WASH	218
1333	WASH	218
1401	PASSUM	27
1411	PASSUM	26/36
1412	PASSUM	26
1413	PASSUM	26
1415	PASSUM	36
1416	PASSUM	36
1421	PASSUM	28/38
1422	PASSUM	28
1423	PASSUM	27
1424	PASSUM	28
1427	PASSUM	38
1431	PASSUM	30/39/42
1432	PASSUM	30
1433	PASSUM	30
1434	PASSUM	30
1436	PASSUM	39
1438	PASSUM	42
1440	PASSUM	33
1441	PASSUM	33

Code	Series	Page
1442	PASSUM	33
1444	PASSUM	33
1451	SQUEEZE	58
1453	SQUEEZE	56
1454	SQUEEZE	56
1455	SQUEEZE	56
1457	SQUEEZE	56
1458	SQUEEZE	56
1459	SQUEEZE	56
1462	RGBW	320
1464	RGBW	320
1467	SQUEEZE	57
1468	SQUEEZE	57
1469	SQUEEZE	57
1470	PASSUM	46
1471	PASSUM	48
1472	PASSUM	46
1473	PASSUM	46
1474	PASSUM	47
1475	PASSUM	47
1476	PASSUM	48
1478	PASSUM	48
1479	PASSUM	47
1481	PASSUM	36
1482	RGBW	321
1484	PASSUM	36
1485	PASSUM	38
1487	PASSUM	39
1488	PASSUM	42
1491	PASSUM	26
1494	PASSUM	26
1495	PASSUM	28
1496	PASSUM	28
1497	PASSUM	30
1498	PASSUM	30

INDICE PER CODICE

INDEX BY CODE

Code	Series	Page
1511	PASSUM	26
1512	PASSUM	26
1513	PASSUM	26
1515	PASSUM	37
1516	PASSUM	37
1517	PASSUM	37
1519	PASSUM	37
1521	PASSUM	27/29
1522	PASSUM	27/29
1523	PASSUM	27/29
1525	PASSUM	38
1526	PASSUM	38
1527	PASSUM	38
1529	PASSUM	38
1531	PASSUM	31
1532	PASSUM	31
1533	PASSUM	31
1535	PASSUM	39
1536	PASSUM	39
1537	PASSUM	39
1539	PASSUM	39
1541	PASSUM	33
1542	PASSUM	33
1591	PASSUM	37
1593	PASSUM	37
1594	PASSUM	37
1924	ACCESSORI / ACCESSORIES	50/59/76/325/327
1925	ACCESSORI / ACCESSORIES	50/59/76/325/327
1926	ACCESSORI / ACCESSORIES	325/327
1941	ACCESSORI / ACCESSORIES	51/71/108/139/326
1942	ACCESSORI / ACCESSORIES	51/108/139/326
1943	ACCESSORI / ACCESSORIES	267/326
1944	ACCESSORI / ACCESSORIES	51/71/108/326
1956	ACCESSORI / ACCESSORIES	327
1957	ACCESSORI / ACCESSORIES	327

Code	Series	Page
1965	ACCESSORI / ACCESSORIES	327
1966	ACCESSORI / ACCESSORIES	327
1971	PASSUM	51
1972	PASSUM	51
2101	JACK	306
2105	JACK	306
2143	JACK	307
2146	JACK	307
2191	JACK	306
2195	JACK	306
2201	JACK	306
2213	JACK	306
2214	JACK	306
2215	JACK	306
2216	JACK	306
2217	JACK	306
2241	JACK	307
2263	JACK	307
2264	JACK	307
2265	JACK	307
2267	JACK	307
2291	JACK	306
2481	MARINA	315
2495	MARINA	315
2806	MARINA	313
2825	MARINA	313
2895	MARINA	313
3101	T-LUX	170
3102	T-LUX	170
3103	T-LUX	170
3341	TRIANGOLO	255
3344	TRIANGOLO	255
3401	IANUS	147
3402	IANUS	147
3421	CANTHARELLUS	181

Code	Series	Page
3422	CANTHARELLUS	181
3423	CANTHARELLUS	181
3501	I-MAGO / I-LUX / I-DEA	195/204/211
3502	I-MAGO / I-LUX / I-DEA	195/204/211
3504	PROTO / CANTHUS	124/188
3505	PROTO / CANTHUS	124/188
3511	I-MAGO / I-LUX	195/204
3512	I-MAGO / I-LUX	195/204
3601	T-LUX	165
3602	T-LUX	165
3603	T-LUX	165
4170	TRIANGOLO	254
4220	TRIANGOLO	254
4223	TRIANGOLO	254
4225	TRIANGOLO	255
4229	TRIANGOLO	254
4230	TRIANGOLO	254
4301	JACK	306
4302	JACK	306
4413	DOCKS	292
4450	SMALL MIDI MAXI & SUPERMAXI	244
4451	JACK	306
4453	JACK	306
4470	DOCKS	290
4472	DOCKS	290
4474	DOCKS	290
4475	DOCKS	290
4478	DOCKS	291
4479	DOCKS	291
4480	DOCKS	292
4481	DOCKS	292
4487	DOCKS	291
4488	DOCKS	291
4489	DOCKS	292
4510	MARINA	313

Code	Series	Page
4520	MARINA	313
4560	MARINA	312
4580	MARINA	312
4590	MARINA	313
4592	MARINA	312
4661	CLOCK	107
4664	CLOCK	107
4665	CLOCK	107
4668	CLOCK	108
4669	CLOCK	108
4691	CLOCK	109
4692	CLOCK	109
4693	CLOCK	113
4694	CLOCK	113
4695	CLOCK	113
4696	CLOCK / T-LUX	114/170
4697	CLOCK / T-LUX	114/171
4698	CLOCK / T-LUX	114/171
4699	CLOCK	113
4720	MARINA	314
4780	MARINA	314
4790	MARINA	314
4792	MARINA	314
4935	PROTO	120
4936	PROTO	120
4937	PROTO	120
4938	PROTO	120
5061	PROTO	124
5062	PROTO	124
5066	VOLTO	261
5080	SMALL MIDI MAXI & SUPERMAXI	248
5081	VOLTO	261
5091	SMALL MIDI MAXI & SUPERMAXI	248
5212	SMALL MIDI MAXI & SUPERMAXI	245
5213	SMALL MIDI MAXI & SUPERMAXI	245

INDICE PER CODICE

INDEX BY CODE

Code	Series	Page
5221	SMALL MIDI MAXI & SUPERMAXI	245
5223	SMALL MIDI MAXI & SUPERMAXI	245
5232	SMALL MIDI MAXI & SUPERMAXI	245
5233	SMALL MIDI MAXI & SUPERMAXI	245
5301	SERVER POINT	130
5302	SERVER POINT	130
5303	SERVER POINT	130
5308	SERVER POINT	131
5309	SERVER POINT	131
5315	SERVER POINT	131
5321	STAMP	64
5323	STAMP	64
5326	STAMP	64
5331	STAMP	74
5335	STAMP	80
5336	STAMP	80
5337	STAMP	80
5351	STAMP	66/76/81
5352	STAMP	66
5357	STAMP	66
5358	STAMP	66/77
5359	STAMP	66
5360	STAMP	67/77/81
5371	STAMP	68
5372	STAMP	68
5374	STAMP	75
5375	STAMP	75
5381	STAMP	68
5382	STAMP	68
5383	STAMP	68
5384	STAMP	68
5391	STAMP	71/75
5392	STAMP	71
5401	QUANTUM	96
5402	QUANTUM	96

Code	Series	Page
5405	QUANTUM	96
5406	QUANTUM	96
5407	QUANTUM	96
5411	QUANTUM	95
5412	QUANTUM	95
5415	QUANTUM	95
5416	QUANTUM	95
5420	QUANTUM	89
5425	QUANTUM	88
5430	QUANTUM	90
5435	QUANTUM	91
5440	QUANTUM	92
5441	QUANTUM	88
5442	QUANTUM	89
5443	QUANTUM	90
5444	QUANTUM	91
5452	QUANTUM	88
5453	QUANTUM	90
5454	QUANTUM	91
5455	QUANTUM	93
5460	QUANTUM	89
5462	QUANTUM	88
5463	QUANTUM	90
5464	QUANTUM	91
5465	QUANTUM	93
5466	QUANTUM	93
5467	QUANTUM	93
5472	QUANTUM	88
5473	QUANTUM	90
5474	QUANTUM	91
5475	QUANTUM	93
5476	QUANTUM	93
5477	QUANTUM	93
5480	QUANTUM	94
5481	QUANTUM	94

Code	Series	Page
5482	QUANTUM	94
5495	QUANTUM	99
5496	QUANTUM	98
5500	I-MAGO	195
5501	I-LUX	202
5502	I-LUX	202
5503	I-LUX	202
5504	I-LUX	202
5505	I-MAGO / I-LUX / I-DEA	196/205/211
5506	IANUS / CANTHARELLUS / I-MAGO / I-LUX	147/181/196/205
5510	I-MAGO	195
5511	I-LUX	204
5512	I-LUX	204
5515	I-LUX	204
5516	I-LUX	204
5517	I-LUX	202
5518	IANUS	147
5519	CANTHARELLUS / I-MAGO / I-LUX / I-DEA	181/196/205/211
5521	CANTHARELLUS	180
5522	CANTHARELLUS	180
5523	CANTHUS	188
5524	CANTHUS	188
5526	STANDING	138
5527	IANUS	157
5528	STANDING	139
5529	QUANTUM / STANDING	101/139
5531	I-DEA	210
5534	I-DEA	210
5536	I-DEA	210
5537	I-DEA	210
5538	CLOCK / IANUS / T-LUX	114/150/165
5540	I-LUX	202
5551	T-LUX	168
5552	T-LUX	168

Code	Series	Page
5553	T-LUX	164
5555	T-LUX	165
5558	T-LUX	174
5559	T-LUX	174
5591	QUANTUM	98
5593	QUANTUM	100
5594	QUANTUM	100
5596	QUANTUM	99
5597	QUANTUM	100
5598	QUANTUM	99
5599	QUANTUM	100
5606	SMALL MIDI MAXI & SUPERMAXI	242
5607	SMALL MIDI MAXI & SUPERMAXI	242
5608	SMALL MIDI MAXI & SUPERMAXI	242
5618	SMALL MIDI MAXI & SUPERMAXI	243
5619	SMALL MIDI MAXI & SUPERMAXI	243
5621	SMALL MIDI MAXI & SUPERMAXI	243
5626	SMALL MIDI MAXI & SUPERMAXI	243
5627	SMALL MIDI MAXI & SUPERMAXI	243
5636	SMALL MIDI MAXI & SUPERMAXI	244
5637	SMALL MIDI MAXI & SUPERMAXI	244
5638	SMALL MIDI MAXI & SUPERMAXI	244
5652	SMALL MIDI MAXI & SUPERMAXI	244
5653	SMALL MIDI MAXI & SUPERMAXI	244
5692	SMALL MIDI MAXI & SUPERMAXI	247
5693	SMALL MIDI MAXI & SUPERMAXI	247
5694	SMALL MIDI MAXI & SUPERMAXI	247
5696	SMALL MIDI MAXI & SUPERMAXI	247
5700	SMALL MIDI MAXI & SUPERMAXI	246
5704	SMALL MIDI MAXI & SUPERMAXI	246
5705	SMALL MIDI MAXI & SUPERMAXI	247
5708	SMALL MIDI MAXI & SUPERMAXI	247
5863	VOLTO	260
5864	VOLTO	261
7071	IANUS	146

INDICE PER CODICE

INDEX BY CODE

Code	Series	Page
7072	IANUS	146
7073	IANUS	150
7074	IANUS	150
7075	IANUS	150
7076	IANUS	150
7081	IANUS	156
7082	IANUS	156
7083	IANUS	157
7084	IANUS	157
8110	KASKO	301
8190	KASKO	301
8310	KASKO	299
8320	KASKO	299
8390	KASKO	299
8395	KASKO	299
8410	KASKO	298
8420	KASKO	298
8490	KASKO	298
8495	KASKO	298
8610	KASKO	300
8620	KASKO	300
8690	KASKO	300
8695	KASKO	300
8810	KASKO	301
8890	KASKO	301
9000	DOCKS	290
9005	DOCKS	291
9011	DOCKS	292
9020	DOCKS	290
9025	DOCKS	291
9031	DOCKS	292
9060	DOCKS	290
9064	DOCKS	291
9067	DOCKS	292
9070	DOCKS	290

Code	Series	Page
9074	DOCKS	291
9077	DOCKS	292
9101	DOCKS	290
9102	DOCKS	290
9104	DOCKS	290
9105	DOCKS	290
9106	DOCKS	290
9107	DOCKS	290
9108	DOCKS	290
9109	DOCKS	290
9117	DOCKS	291
9119	DOCKS	291
9121	DOCKS	291
9122	DOCKS	291
9124	DOCKS	292
9125	DOCKS	292
9127	DOCKS	292
9128	DOCKS	292
9130	DOCKS	291
9131	DOCKS	291
9133	DOCKS	291
9134	DOCKS	291
9136	DOCKS	292
9137	DOCKS	292
9138	DOCKS	292
9139	DOCKS	292
9150	KASKO	298
9151	KASKO	298
9152	KASKO	298
9154	KASKO	298
9155	KASKO	298
9156	KASKO	298
9160	KASKO	299
9161	KASKO	299
9162	KASKO	299

Code	Series	Page
9164	KASKO	299
9165	KASKO	299
9166	KASKO	299
9170	KASKO	300
9171	KASKO	300
9172	KASKO	300
9174	KASKO	300
9175	KASKO	300
9176	KASKO	300
9182	KASKO	301
9184	KASKO	301
9186	KASKO	301
9187	KASKO	301
9201	LUNETTE	284
9202	LUNETTE	284
9203	LUNETTE	284
9204	LUNETTE	284
9206	LUNETTE	284
9207	LUNETTE	284
9208	LUNETTE	284
9209	LUNETTE	284
9211	LUNETTE	285
9212	LUNETTE	285



goccia
ILLUMINAZIONE



Consultate sul sito www.goccia.it l'elenco aggiornato degli agenti /
See the complete list of agents and distributors on www.goccia.it

Goccia Illuminazione srl

Via E. Fermi, 59/65
25020 Poncarale (BS) Italy
T. +39 030 26 40 761
F. +39 030 26 40 271

info@goccia.it
www.goccia.it

