

K³ WRITER

K³ WRITER
1091 Lente convergente per 1 lama – Converging lens
Lentille convergente – Konvexlinse



goccia
ILLUMINAZIONE

cod doc. 91366 rev. C
cod. 089136600

 Per l'installazione su apparecchi LED
1004, 1008, 1022, 1014, 1018, 1033,
seguire le istruzioni di questa pagina (1)

Per l'installazione su apparecchi HQI
1001, 1002, 1006, 1007, 1020, 1021,
1011, 1012, 1016, 1017, 1031, 1032,
seguire le istruzioni a pag. 2.

Rispettare l'orientamento della lente secondo
l'etichetta: MURO ---> WALL.

 For installation on LED fixtures
1004, 1008, 1022, 1014, 1018, 1033,
follow instructions on this page (1)

For installation on HQI fixtures
1001, 1002, 1006, 1007, 1020, 1021,
1011, 1012, 1016, 1017, 1031, 1032
follow instructions on page 2.

Install the lens according with the label:
MURO ---> WALL.

 Pour l'installation sur des luminaires LED
1004, 1008, 1022, 1014, 1018, 1033,
suivez les instructions sur cette page (1)

Pour l'installation sur des appareils HQI
1001, 1002, 1006, 1007, 1020, 1021,
1011, 1012, 1016, 1017, 1031, 1032
suivez les instructions à la page 2.

Installez la lentille conformément à l'étiquette:
MURO ---> WALL.

 Zur Installation auf LED-Leuchten
1004, 1008, 1022, 1014, 1018, 1033,
die Anweisungen auf dieser Seite (1) befolgen

Zur Installation auf HQI-Leuchten
1001, 1002, 1006, 1007, 1020, 1021,
1011, 1012, 1016, 1017, 1031, 1032
die Anweisungen auf Seite 2 befolgen.

Die Linse der Beschreibung entsprechend
installieren. MURO ---> WALL.

K3 WRITER LED

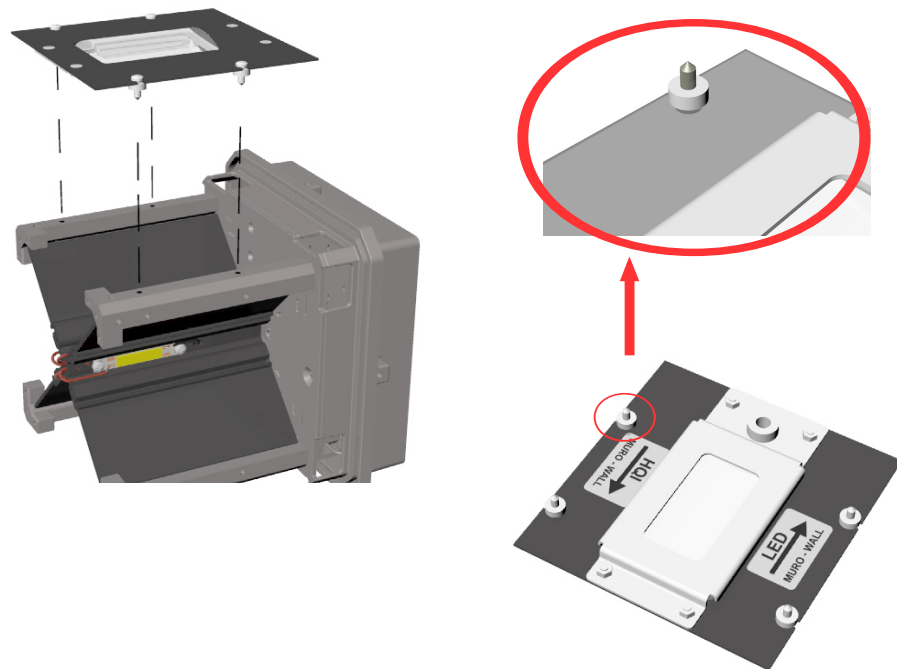

 RIMUOVERE LA
GRIGLIA
ANTIABBAGLIANTE
PRIMA DI MONTARE
L'ACCESSORIO 1091

Le 4 viti su asole
consentono il corretto
centraggio orizzontale
per l'allineamento del
fascio.
Non rimuovere i
distanziali indicati.

 REMOVE THE ANTI-
GLARE GRILLE
BEFORE INSTALLING
THE 1091 ACCESSORY

The 4 screws and their
oval buttonholes permit to
direct and regulate the
light.
Do not remove the
spacers.

 RETIRER LA GRILLE
ANTI-REFLET AVANT
D'INSTALLER
L'ACCESSOIRE 1091

Les 4 vis et ses
boutonnères ovales
permettent d'orienter et
de réguler la lumière.
Ne pas retirer les
entretoises.

 DAS
BLENDSCHUTZGITTER
ENTFERNEN, BEVOR
DAS 1091-ZUBEHÖR
INSTALLIERUNG

Die 4 Schrauben und die
ovalen Langlöcher
ermöglichen die
Ausrichtung und Regeln
des Lichts.
Die Abstandshalter nicht
abziehen.

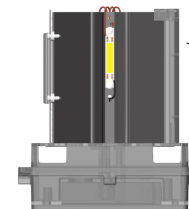

4,5 mt.

K³ WRITER





K³ WRITER
 1091 Lente convergente per 1 lama – Converging lens
 Lentille convergente – Konvexlinse

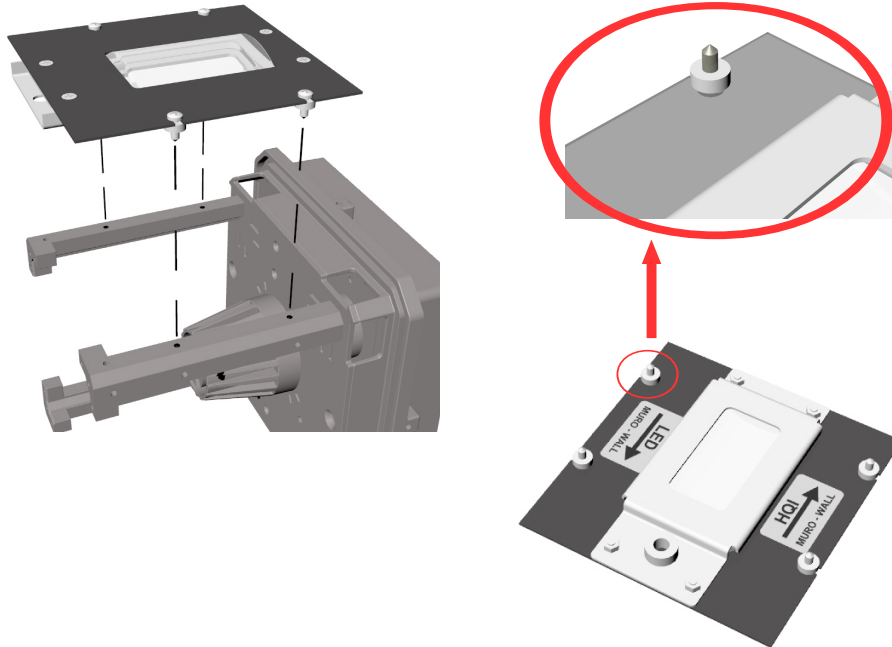

cod doc. 91366 rev. C
 cod. 089136600

K3 WRITER HQI



<p> Le 4 viti su asole consentono il corretto centraggio orizzontale per l'allineamento del fascio. Non rimuovere i distanziali indicati.</p>	<p> The 4 screws and their oval buttonholes permit to direct and regulate the light. Do not remove the spacers.</p>	<p> Les 4 vis et ses boutonnières ovales permettent d'orienter et de réguler la lumière. Ne pas retirer les entretoises.</p>	<p> Die 4 Schrauben und die ovalen Langlöcher ermöglichen die Ausrichtung und Regeln des Lichts. Die Abstandshalter nicht abziehen.</p>
--	--	---	--

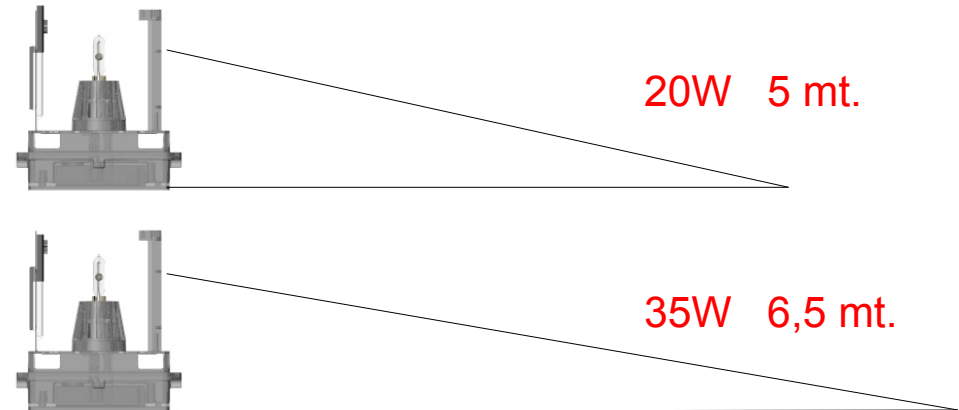

Regolazione orizzontale - Horizontal adjusting - Réglage horizontal - Horizontale Regulierung

